

'AQ' QUADRANT FITTING INSTRUCTIONS

1. Fit the shower tray ensuring it is level across all areas (Fig 1).
Apply silicone sealant to the edges of the tray before and after tiling.
2. Assemble the frame by fixing the top & bottom rails to the fixed glass panels and fix in position screwing through the aluminium posts into the rails using the 40mm screws (Fig 2/3).
3. Fit the glass clamps using the 10mm counter sunk screws (Fig 4).
4. Fit the rubber door stops using the 10mm round headed screws (Fig 5)
The bottom water seal can be fitted at this point (Fig 6).
5. Take the wall posts and set 10mm to 15mm, depending on the tile depth, in from the edge of the tray.
Using a spirit level ensure that the wall posts are vertical and plumb (Fig 7).
Mark the hole positions (Fig 8), remove and drill for wall plugs, then fit the plugs.
6. Slide the wall posts onto either end of the frame. Carefully, lift the frame into position and fix to the wall using the 30mm screws. Ensure that the screw collars are fitted to the screw beforehand. Taking care not to scratch the unit, mark and drill two 3.2mm holes 150mm from the top & bottom on the inside of the enclosure through the wall posts and frame (Fig 9). Secure with the 10mm screws, again ensuring that the collars are in place.
7. Fix the top wheels to the glass door ensuring the correct hand for installation by unclipping and lowering the cover cap. Undo the retaining nut and fix through the hole in the glass and re-tighten (Fig 10). Final adjustment can be made by slackening the nut when the assembly is complete.
8. Fix the bottom wheels into position by dis-assembling the wheel and placing the plastic saddle over the glass. Tighten in position through the hole in the glass. Place the spring over the spigot within the wheel housing (Sketch A) and slide the wheel onto the plastic saddle. Re-fit the cover cap (Fig 11).
If the door does not run true, final adjustment can be made by adjusting the top wheels. Slacken the retaining nut and adjust up and down accordingly. Re-tighten the nut.
9. Hang the doors onto the top rail making sure that the wheels are located in the channel (Fig 12) Then from the outside, push down on the spring loaded wheels and clip into position (Fig 13).
10. Cut to length the magnetic jointing strips and seal. Slide the magnetic strip into the side rail and clip the magnetic seal onto door ensuring that the offset marries up with the magnetic strip. Cut to length the two vertical water seals and clip into position on the glass doors and glass side panels (Fig 14).
12. Finish by fitting the handles, decorative caps supplied and apply silicone down the vertical edges of the wall channel, and the bottom edge between the bottom rail and tray. (Fig 15/16). **DO NOT SEAL THE ENCLOSURE ON THE INSIDE OF THE ENCLOSURE!**

Fig. 1



Fig. 2

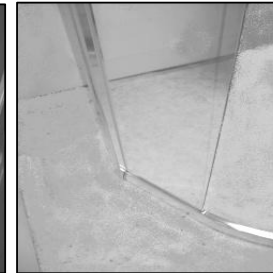

Fig. 3

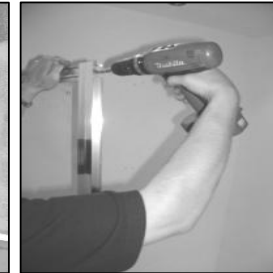

Fig. 4

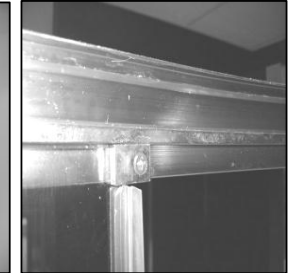

Fig. 5

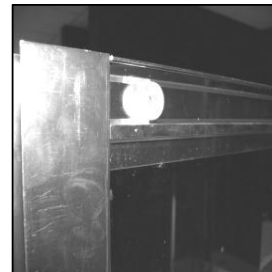

Fig. 6

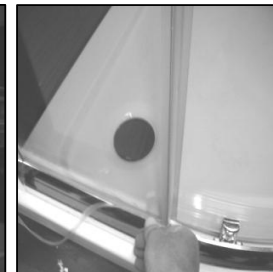

Fig. 7



Fig. 8

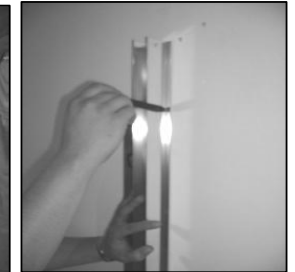

Fig. 9



Fig. 10



Fig. 11

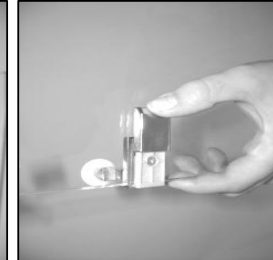

Fig. 12

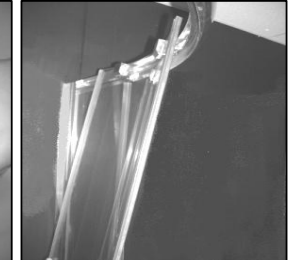

Fig. 13

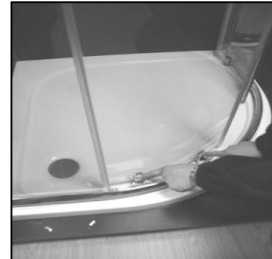

Fig. 14

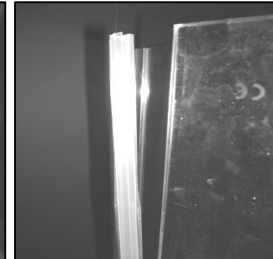

Fig. 15

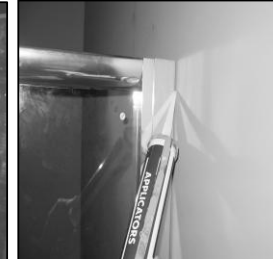
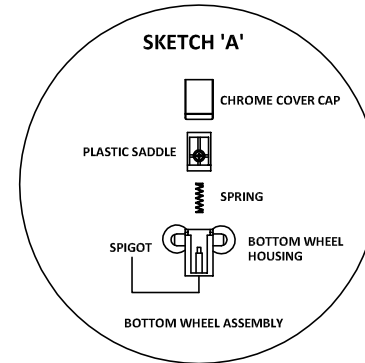
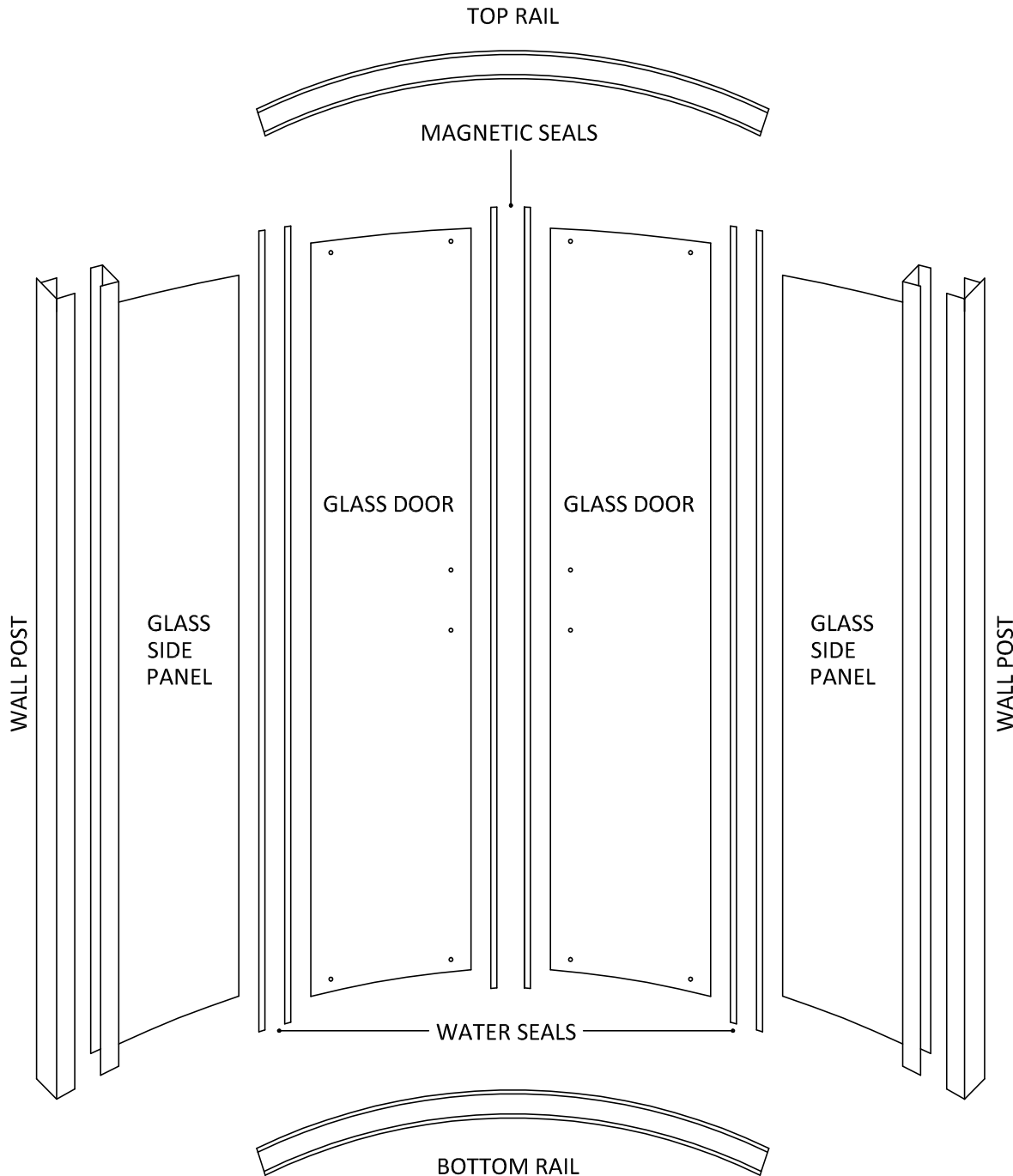

















Fig. 16



AQ QUADRANT FITTING INSTRUCTION



AQ QUADRANT PARTS LIST		
	MAGNETIC SEAL	2
	VERTICAL SEAL	4
	BOTTOM GLASS SEAL	1
	SCREW COLLAR	10
	SCREW COVER CAPS	10
	GLASS CLAMP	4
	RUBBER DOOR STOP	8
	WALL PLUGS	6
	40mm SCREWS	8
	30mm SCREWS	6
	10mm R/H SCREWS	12
	10mm C/S SCREWS	4
	BOTTOM WHEEL ASSEMBLY	4
	TOP WHEEL ASSEMBLY	4
	WALL POST COVER CAPS	2
	DOOR HANDLE	2