

PEARLSTONE

SHOWER TRAY FLAT TO FLOOR INSTALLATION

Pearlstone Shower Tray installation onto a timber floor.

It is recommended that all flat top shower trays are installed before tiling to ensure that the top radius of the tray is behind or at least below the tile face. This will help to create a water tight seal. (see diagram overleaf)

Carefully lower the tray into the chosen position, then mark the floor for the waste opening. Remove the tray.

Check below the floor level to ensure that there is adequate access for the waste and pipe work. If an obstruction is found, drill a hole and make provision in the floor of a sufficient diameter to allow the entire waste coupling to fall below the floor level.

Make sure the floorboards are securely fixed. If this is not possible, use 18/20mm thick green grade chipboard, cut to the size of the tray and fix in place.

Caution!! Before attempting to secure any loose floorboards or the chipboard to the floorboards, check that there are no pipes or electrical connections beneath the floor level.

Seal the installation area with a suitable clear waterproofing agent.

Fit the waste and trap to the tray. It is recommended that you use a suitable silicone sealant around the waste to create a watertight seal.

Ensure that the entire base of the tray is fully supported. The tray has to be FULLY COVERED with a 5mm minimum thickness of weak cement mix. (See below)

The minimum 5mm thickness is at the lowest point of the tray after the tray has been levelled.

Check that the top of the tray is level.

(Note the base of the tray has a built-in fall to allow for drainage).

In the case of a flat top shower tray, it is advised that all the tray to wall joints are now sealed with a bead of silicone sealant, once this has been done the walls can be tiled.

Ensure that you apply an additional bead of silicone sealant between the tray and the tiles, prior to fitting the wall channels.

How To Mix Up A Standard Mortar

Mix 1 part ordinary cement to 5 parts soft sand. Mix the two together on a smooth hard surface. Measure the sand and then add the cement on top. Turn them together until they make a uniform colour. Make a crater and add water gradually. Turn the mix into the water to a flexible consistency. It must not be runny!

Installation Onto A Solid Or Restricted Access Floor.

Where it is difficult to run a waste assembly under the floor, we recommend that you utilise our Universal Leg Set & Panel Kit. This is designed and specified for such installations to support the tray & give access to the waste behind removable panels.

PEARLSTONE

SHOWER TRAY FLAT TO FLOOR INSTALLATION

Thank you for purchasing your Pearlstone tray. Please fully read these installation procedures and familiarise yourself with the components before commencement.

Please inspect the product immediately and fully upon receipt and prior to installation for transit damage, or any defects. Damage or defects reported later cannot be accepted.

Your tray comes with a protective film. Peel back to inspect then replace.

Do not discard the packaging as some of it is utilised throughout the installation procedures.

Fitting a Pearlstone shower tray to the floor.

For the best results & ease of installation determine the waste position of the tray.

Place the tray in the desired position or best location to simplify the installation.

The tray can be rotated indexing the waste to the most suitable position.

Fit the waste assembly & exit pipe work (following the waste manufacturers instruction & advice)

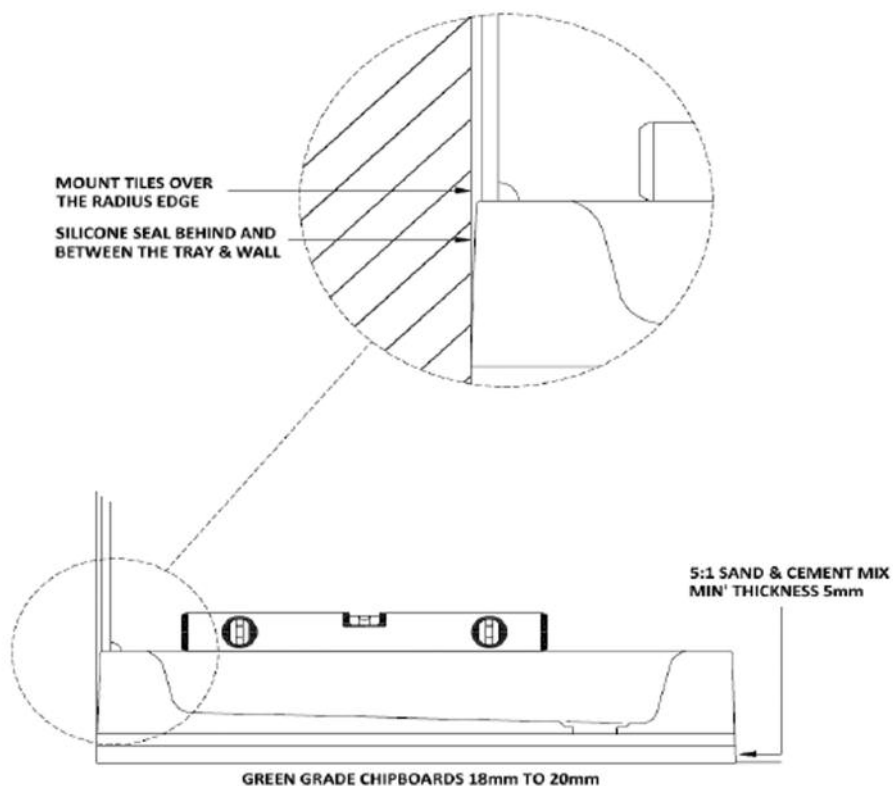

PEARLSTONE

UNIVERSAL LEG SET & PANEL KIT

Thank you for purchasing your Pearlstone tray. Please fully read these installation procedures and familiarise yourself with the components before commencement.

Please inspect the product immediately and fully upon receipt and prior to installation for transit damage, or any defects. Damage or defects reported later cannot be accepted.

Your tray comes with a protective film. Peel back to inspect then replace.

Do not discard the packaging as some of it is utilised through out the installation procedures.

Assembly of the Universal Leg Set & Panel Kit

For the best results & ease of installation determine the waste position of the tray.

Place the tray in the desired position or best location to simplify the installation.

The tray can be rotated indexing the waste to the most suitable position.

Fit the waste assembly & exit pipe work (following the waste manufacturers instruction & advice)

Place the tray face down on a protective surface or packaging.

See over the page and check your size & type of product.

Align the legs and panel clips to the diagram overleaf which suits your product.

Your Pearlstone tray is supported by a new reinforcement material with the ability to screw into.

Secure each leg with x3 (13mm) 1/2" x No8 round headed screws provided.

Under no circumstances use a longer screw for fixing into the base.

Adjust the leg so that the overall assembly is a 100mm to suit the panel location and lightly tighten the hexagonal nut.

Depending on which leg clip has been supplied, screw the panel clips to the underside of the tray as illustrated overleaf. **It is important that the correct screw size is used for this operation.**

We recommend that the metal clip is fitted so that it overhangs the tray 4mm.

The plastic clip should be fitted to suit the panel return depth as this may vary.

Note! When moving your tray into position, do not slide as this can loosen the leg fixings.

In most cases, your plastic panel(s) is supplied over length.

Place onto the clips following the contour of the product if applicable.

Mark the panel to length at each end & cut accurately to length with a fine toothed saw.

Remove the panel.

Turn over the tray & adjust the adjustable feet to level the tray. Fit the panel which is 100mm in height into its desired location.

Check with a spirit level that the tray is correctly levelled and fully tighten the hexagonal nuts on the legs.

Scribe a line on the floor where the panel will sit.

Fit to the floor behind the scribed line taking account of the panel return lip. Fit several small blocks of wood (not supplied) to ensure the panel remains stable.

It is recommended that the legs at the front of the tray are screwed to the floor.

Special care should be taken when using power tools & when drilling take care to avoid hidden pipes or electrical cables.

SQUARE TRAYS

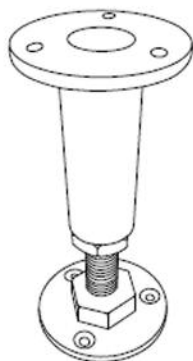
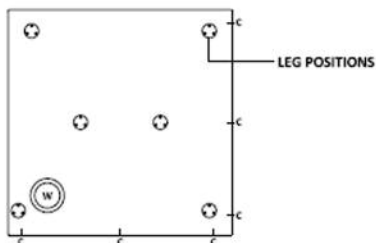

ADJUSTABLE FOOT (x6)



SCREWS 1/2" x No 8 RH (x18)

EQUAL QUADRANT TRAYS

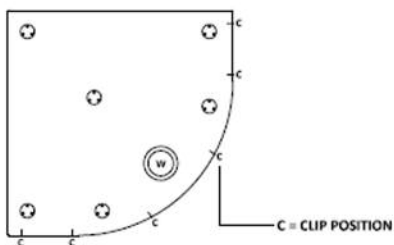

OFFSET QUADRANT TRAYS

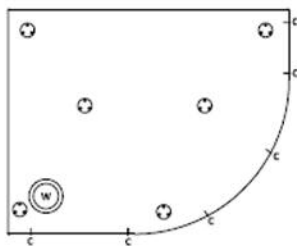

RECTANGULAR TRAYS

Length 1000, 1100 & 1200mm Long

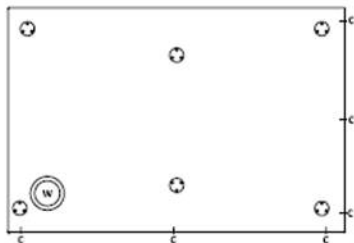

LARGE RECTANGULAR TRAYS

Length 1400, 1500, 1600 & 1700mm Long

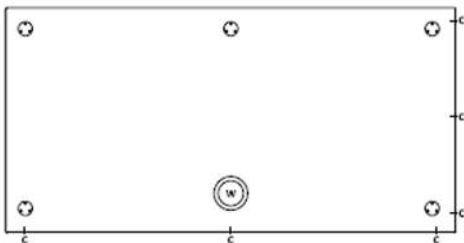

PLASTIC PANEL CLIPS (x6)



SCREWS 1" x No 8 RH (x12)



METAL PANEL CLIPS (x6)



SCREWS 1/2" x No 8 RH (x12)

ON RECTANGULAR TRAYS, ENSURE THE PANEL CLIPS ARE FITTED TO THE SIDE REQUIRING PANELS. THIS IS DEPENDENT ON THE WASTE POSITION.