

TECHNICAL DATASHEET



450mm WALL MOUNTED BASIN

Barcode	5055369031047
Product Code	NCU842
Finishes	WHITE
Product Type	CERAMIC



Guarantee & Aftercare

During installation extra care must be taken to avoid damaging the fittings. We provide a 5 year guarantee against faulty workmanship or materials (excluding serviceable parts), providing they have been installed, cared for and used in accordance with our instructions.

ADDITIONAL INFORMATION—The basin complies with the following standards.

- BS 3402: 1969: Specification for quality of vitreous china sanitary appliances
- Water supply regulations 1999

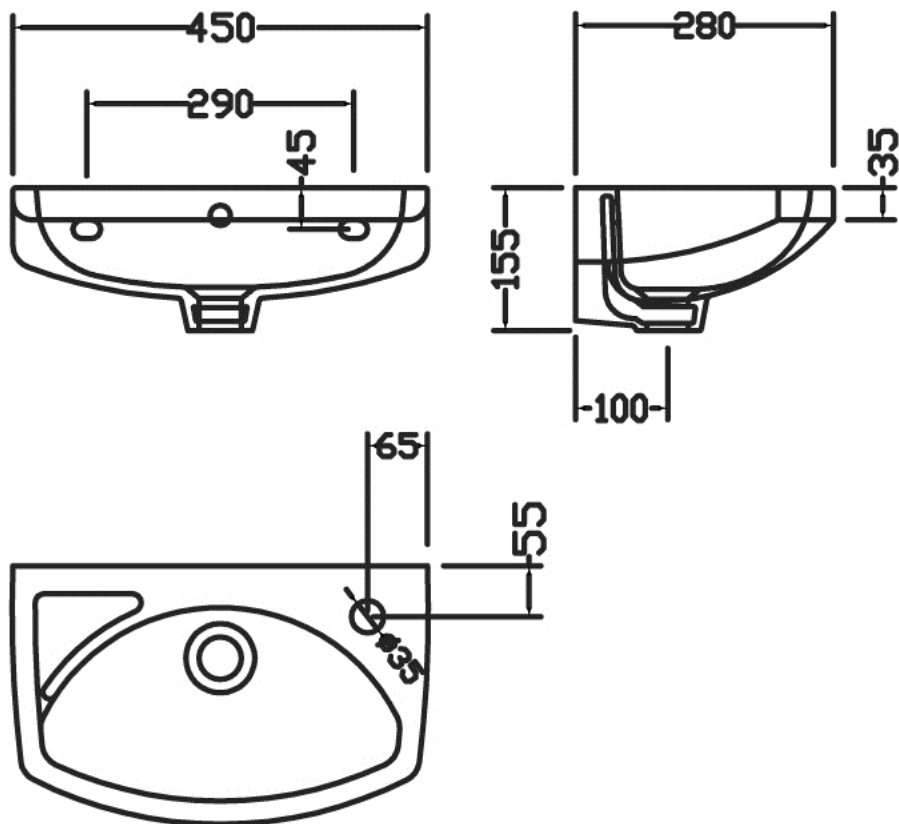

CUSTOMER CARE: For further information please call 01282 446789