

crosswater<sup>®</sup>  
PREMIUM



Shower Enclosures & Trays

# Twenty years of bathroom obsession

*We understand bathrooms. Over 20 years the bathroom has evolved from a rationale space for washing and cleansing to an emotional one focused on relaxation and rejuvenation. In response, Crosswater has curated an extensive range of products to delight our customers, always.*

At Crosswater, we readily embrace the latest cutting-edge manufacturing processes and design trends to provide a premium selection of enclosures, bath screens and shower trays, to deliver a truly exceptional showering solution. If it is a wet room you are looking for, we offer frameless shower panels and a selection of

low and level-access shower trays to help you create that seamless look. All of our shower screens are finished with 'Crosswater Clear' which helps reduce staining ensuring that your shower looks as good as new with each use.

## Contents

### Introduction 4

Choosing your Shower Enclosure, Tray or Bath Screen	4
Shower Enclosures & Trays - Style Finder	6

### Shower Enclosures 8

Design+ Matt Black	10
Design+ Matt Black with Hush Technology	16
Design+	20
Svelte	32
Infinity	40
Zion	48
Pier	54
Ten	60
Edge	66
Click	76
Supreme	80

### Sundries 90

### Bath Screens 92

Design+ Matt Black	94
Design+	98
Svelte	102
Infinity	103
Ten	104
Zion	105
Click	106
Edge	109
Supreme	110
Folding Shower Seat	113

### Shower Trays 114

30mm PLUS+TON® Ceramic	116
25mm Storm Grey Stone Resin	118
25mm Stone Resin	120
25mm Stone Resin with Linear Waste	122
25mm Kai & Anti-Slip Stone Resin	124
45mm Stone Resin	126
Shower Tray Frames & Panels	127

### Wet Rooms 128

Level Access Trays	130
Linear Level Access Shower Trays	132
Panels & Installation Components	134
Level Access Installation	136



# Choosing your Shower Enclosure, Tray or Bath Screen

*The Crosswater enclosures, trays and bath screen portfolio offers an exciting range of options which cover a vast variety of styles, finishes and performance benefits. Please follow the simple steps below to create your own personal showering enclosure.*

## step 1 CHOOSE YOUR SIZE AND ACCESS METHOD

Depending on your available space and design preferences you should start by choosing the size and access method that you require to contain your perfect shower experience.

### Enclosures

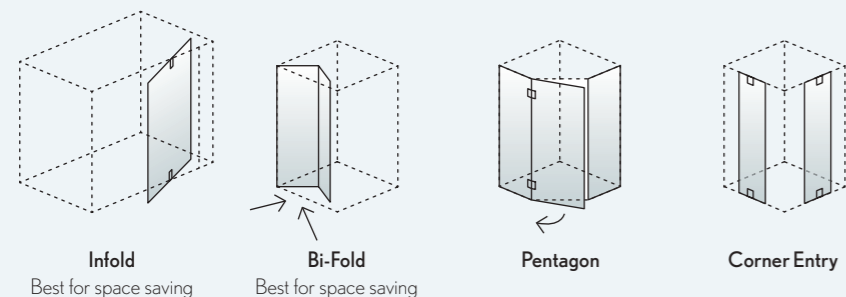
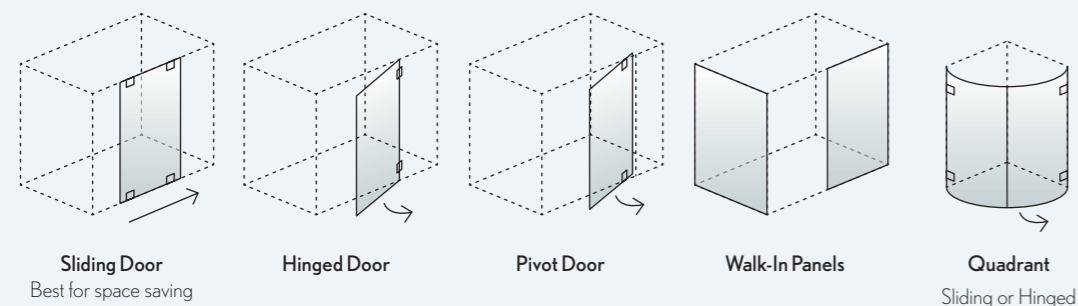

### Bath Screens

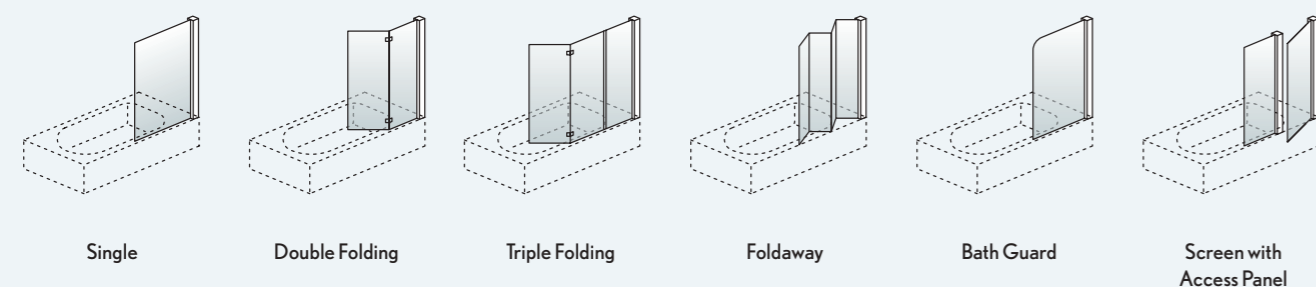

## step 2 CHOOSING A SHOWER TRAY

Once you have determined the size and access method of your shower enclosure you need to select a matching shower tray.

### Tray Height & Material

In most situations, consumers are looking to achieve the most minimal look in the bathroom and therefore gravitate towards our thinnest profile of 25mm. All Crosswater 25mm trays are crafted from natural stone resin with an even gel coat which is very strong, long-lasting and carries a lifetime warranty.

If you are looking for a stone resin alternative to our 25mm trays at a more competitive price point along with the lifetime guarantee, Crosswater offer a range of acrylic capped stone resin trays in a thicker 45mm profile.

Finally, for the ultimate in shower tray performance, Crosswater offers a range of 30mm trays in PLUS+TON®. These 100% ceramic trays, crafted in Italy are entirely scratch and stain-proof, as well as almost 100% eco-friendly. They are specially formulated to create the densest, strongest, lightest and smoothest ceramic which also include Bacterclean®, a revolutionary non-toxic, antibacterial treatment.

### Waste Options

Depending on the range specified, the consumer has the option to choose from waste positions. For more accurate waste positions and size information please refer to the tray pages, listed in the style finder.

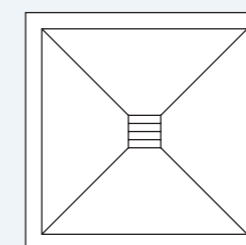

**Centre**  
A centre waste position offers the most direct route for the water to flow from the tray and its flush design prevents an uncomfortable standing position for the user.

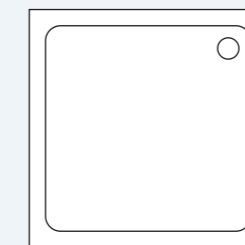

**Edge**  
This option moves the waste away from the standing area of the tray for a more comfortable user experience.

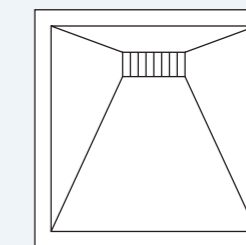

**Linear**  
This option provides the cleanest lines and most minimal user experience.

All Crosswater trays require a separately specified waste (except 25mm stone resin and linear options). All Crosswater wastes are high flow removing 30 litres per minute. In 25mm stone resin, Kai and PLUS+TON® ranges a patented

VORTEX waste is used which removes the water much more quickly ensuring you are never standing in a pool of water at the base of your enclosure.

### Finish Options

As well as the brilliant white colour in the 25mm stone resin range we offer a stylish Storm Grey finish. In the 'Kai' range, the consumer has the option of a reassuring anti-slip finish. In the PLUS+TON® range, Matt Black finish is also offered.

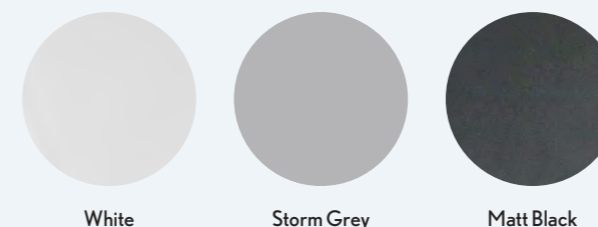

	Slider	Hinged	Pivot	Walk-in	Quadrant	In-fold	Bi-fold	Pentagon	Corner entry	Bath screen	Glass thickness (mm)	Crosswater Clear	Finish	Enclosure Height (mm)
 Click page 74		●							●	●	6	●	Silver	1950
 Design+ page 20	●	●		●	●			●		●	6/8	●	Silver	1950
 Design+ Matt Black with Hush Technology page 16			●								8	●	Matt Black	2000
 Design+ Matt Black page 10	●	●		●						●	6/8	●	Matt Black	1950
 Edge page 66	●		●		●	●	●	●	●	●	6/8	●	Silver	1950
 Infinity page 40	●	●	●	●	●					●	8	●	Polished Stainless Steel	2000
 Pier page 54	●	●		●							8	●	Polished Stainless Steel	1980 /2000
 Supreme page 80	●		●		●		●	●	●	●	4/6	●	Silver	1850
 Svelte page 32	●	●		●	●					●	8	●	Polished Stainless Steel	2000
 Ten page 60	●	●			●					●	10	●	Silver	1950
 Zion page 48		●		●						●	10	●	Polished Stainless Steel	2000

	Square	Rectangle	Quadrant	Offset Quadrant	Pentagon	Centre Waste	Edge Waste	Linear Waste	Vortex Waste	Anti-slip Option
 30mm PLUS+TON® Ceramic page 116		●	●			●	●		●	
 25mm Stone Resin page 120	●	●	●	●		●			●	
 25mm Stone Resin with Linear Waste page 122	●	●						●	●	
 25mm Storm Grey Stone Resin page 118	●	●	●			●			●	
 25mm Kai & Anti-Slip Stone Resin page 124	●	●	●				●		●	●
 45mm Stone Resin page 126	●	●	●	●			●			

## Guide to Icons



### Toughened Safety Glass

Available up to 10mm in thickness, our shower panels and doors come with toughened safety glass as standard, offering complete peace of mind.



### Adjustment for Easy Fitting

We allow for up to a 60mm adjustment on our enclosures, to ensure that installation is easy and adaptable.



### Crosswater Clear as Standard

This invisible coating acts as a lasting barrier on the surface of our enclosure glass, helping to drastically reduce staining from water and chemical deposits. For more information see website.



### Enclosure Height

We offer multiple height options on selected enclosure designs to create a tailored solution to fit every individual space.



### Reversible Design

Whether your enclosure door needs to open to the left or right, our handy reversible function allows for either orientation.



### Door Opening Options

Looking for space-saving folding doors, or opting for inward opening? Whatever your preference, there's a choice of designs available.



### Finishes

There is a range of finish options available on selected enclosure designs, to perfectly complement any bathroom scheme.



### Power Shower Proof

We have carefully developed and tested our shower enclosure screens to ensure they can withstand the optimum performance of a power shower.



### Lifetime Guarantee

The majority of our enclosures come with an impressive Lifetime Guarantee, covering all manufacturing defects to ensure long-lasting durability.



SHOWER ENCLOSURES

# shower in style

*A comprehensive collection of shower enclosures, opt for a variety of door styles, walk-in panels and handle options to create a tailored solution for you.*



NEW

# Design+ Matt Black

Elegance evolved

*Black is the strongest of the neutral shades. Commonly associated with elegance, it is now available in the Design+ enclosure range increasing the creative opportunities and driving design continuity in the bathroom.*

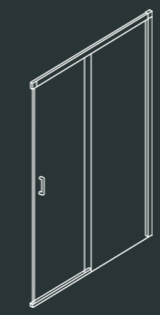

Soft Close Single Slider  
12

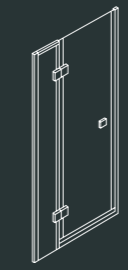

Hinged Door with Inline  
13



Walk-In Panel  
14

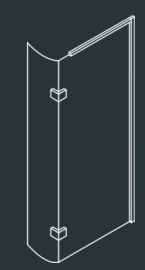

Walk-In Easy Access  
15



# Design+ Matt Black - Soft Close Single Slider

NEW

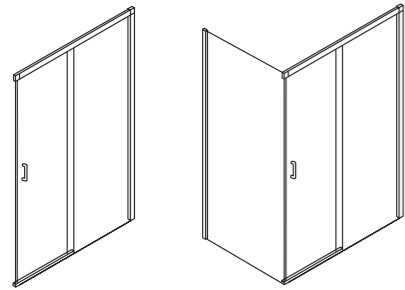

Soft Close Single Slider  
Soft Close Single Slider with Side Panel



Door opening



Shown right: 1200mm Door, 1200 x 900mm 25mm Stone Resin Shower Tray, MPRO Shower Valve, MPRO Matt Black 300mm Shower Head, MPRO Matt Black Shower Arm. To see our full range visit [www.crosswater.co.uk](http://www.crosswater.co.uk)  
Image shown with optional closing profile.

- 8mm toughened glass
- 25mm adjustment for easy fitting
- 1950mm enclosure height
- Power shower proof
- Reversible design
- Sliding door
- Matt Black finish frame
- Wet room compatible
- Easy Clean - Crosswater Clear as standard
- Lifetime Guarantee
- Concealed profile fixings
- Soft & quiet door opening and closing
- Quick release

Width	Door Entry Width	Adjustment	Product Code	PRICE (£)
<b>Soft Close Single Slider</b>				
1200mm	489	1160-1185, 1170-1195*	PRSB1200	<b>NEW</b> £775.00
1400mm	589	1360-1385, 1370-1395*	PRSB1400	<b>NEW</b> £805.00
1700mm	739	1660-1685, 1670-1695*	PRSB1700	<b>NEW</b> £855.00
<b>Side Panel</b>				
800mm	N/A	775-785	PRLSP0800BM	<b>NEW</b> £335.00
900mm	N/A	875-885	PRLSP0900BM	<b>NEW</b> £355.00
<b>Options</b>				
			LNGRID_MB	<b>NEW</b> £45.00
			DSLADJPROFILEMB	<b>NEW</b> £70.00

\*Adjustment when used with a side panel.

For wet room solutions, see page 128.

This enclosure requires a shower tray with a minimum ledge of 60mm.

# Design+ Matt Black - Hinged Door with Inline

NEW

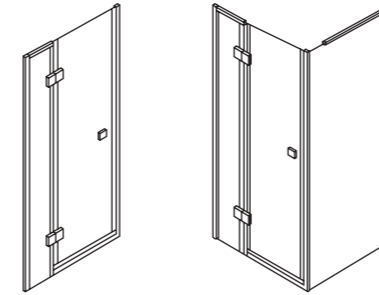

Hinged Door with Inline  
Hinged Door with Inline and Side Panel

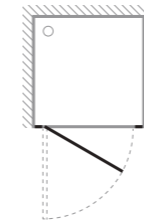

Door opening



Shown right: 25mm Linear Shower Tray, 1200 Hinged Door, MPRO Shower Kit, MPRO Fixed Head and Shower Arm. To see our full range visit [www.crosswater.co.uk](http://www.crosswater.co.uk)

- 6mm door & 8mm fixed
- 25mm adjustment for easy fitting
- 1950mm enclosure height
- Power shower proof
- Reversible design
- Outward opening door
- Matt Black finish frame
- Wet room compatible
- Easy Clean - Crosswater Clear as standard
- Lifetime Guarantee
- Concealed profile fixings

Width	Door Entry Width	Adjustment	Product Code	PRICE (£)
<b>Hinged Door</b>				
800mm	540	770 - 795 (756 - 771*)	PRDBC0800	<b>NEW</b> £760.00
900mm	590	870 - 895 (856 - 871*)	PRDBC0900	<b>NEW</b> £795.00
1000mm	590	970 - 995 (956 - 971*)	PRDBC1000	<b>NEW</b> £855.00
1200mm	640	1170 - 1195 (1156 - 1174*)	PRDBC1200	<b>NEW</b> £925.00
<b>Side Panel</b>				
800mm	N/A	775 - 790	PRSPB0800	<b>NEW</b> £390.00
900mm	N/A	875 - 890	PRSPB0900	<b>NEW</b> £415.00
1000mm	N/A	975 - 990	PRSPB1000	<b>NEW</b> £550.00
1200mm**	N/A	1175 - 1190	PRSPB1200	<b>NEW</b> £645.00

\*Adjustment when used with a side panel.

For wet room solutions, see page 128.

\*\*1200 side/walk in supplied with 90 degree bracing bar for improved stability.



# Design+ Matt Black - Walk-In Panel

NEW

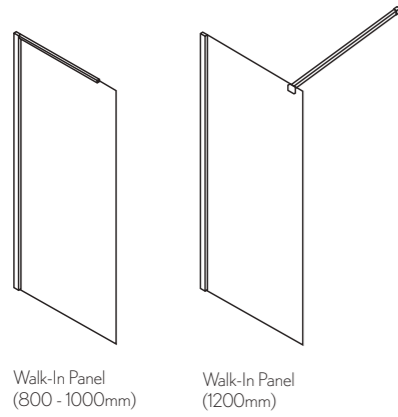

Walk-In Panel (800 - 1000mm)      Walk-In Panel (1200mm)

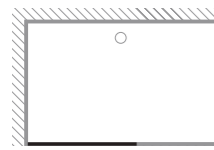

Door opening



Shown right: 25mm Linear Tray 1700 x 800, 1200 Panel, MPRO Shower Head and Shower Arm, MPRO Shower Kit and MPRO Thermostatic Valve. To see our full range visit [www.crosswater.co.uk](http://www.crosswater.co.uk)

- 8mm toughened glass
- 15mm adjustment for easy fitting
- 1950mm enclosure height
- Power shower proof
- Reversible design
- Outward opening door
- Matt Black finish frame
- Wet room compatible
- Easy Clean - Crosswater Clear as standard
- Lifetime Guarantee
- Concealed profile fixings

Width	Door Entry Width	Adjustment	Product Code	PRICE (£)
<b>Walk-In Panel</b>				
800mm	N/A	742 - 757	PRSPB0800	<b>NEW</b> £390.00
900mm	N/A	842 - 857	PRSPB0900	<b>NEW</b> £415.00
1000mm	N/A	942 - 957	PRSPB1000	<b>NEW</b> £550.00
1200mm*	N/A	1142 - 1157	PRSPB1200	<b>NEW</b> £645.00

\*1200 side/walk in supplied with 90 degree bracing bar.

Price per Walk-In panel.  
For wet room solutions, see page 128.

matching valves

Complement with MPRO shower heads, valves & kits. See the Premium Brassware brochure for more information.

# Design+ Matt Black - Walk-In Easy Access

NEW

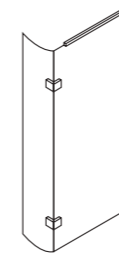

Walk-In Easy Access

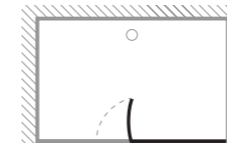

Door opening



Shown right: 25mm Linear Tray 1400x800, MPRO Shower Head, and Shower Arm, MPRO Shower Kit and MPRO Thermostatic Valve. To see our full range visit [www.crosswater.co.uk](http://www.crosswater.co.uk)

- 8mm toughened glass
- 15mm adjustment for easy fitting
- 1950mm enclosure height
- Power shower proof
- Reversible design
- Outward opening door
- Matt Black finish frame
- Wet room compatible
- Easy Clean - Crosswater Clear as standard
- Lifetime Guarantee
- Concealed profile fixings

Width	Door Entry Width	Adjustment	Product Code	PRICE (£)
<b>Walk-In Easy Access</b>				
1400mm	670	1000 - 1015	PWQBC1400	<b>NEW</b> £705.00
700mm (fixed panel) 300mm (return panel)				
1700mm	770	1200 - 1215	PWQBC1700	<b>NEW</b> £825.00
900mm (fixed panel) 300mm (return panel)				

Price per Walk-In panel.  
For wet room solutions, see page 128.







NEW

# Design+ Matt Black

with Hush Technology

*Hear nothing but water. In another first Crosswater brings Design+ Matt Black with Hush super-soft, whisper quiet piston door technology to the UK reducing unnecessary distractions allowing the user to focus completely on the experience.*

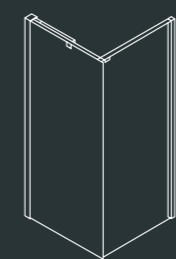

Pivot Door & Side Panel  
18

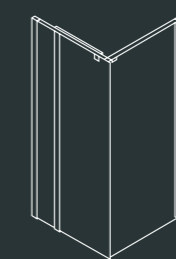

Pivot Door with Inline & Side Panel  
19



# Design+ Matt Black with Hush Technology - Pivot Door & Side Panel

NEW

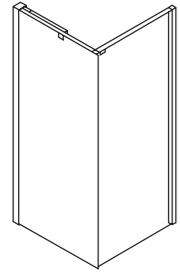

Pivot Door with Side Panel

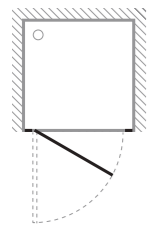

Door opening



Shown right: 25mm Linear Tray 900x900, MPRO Shower Head and Shower Arm, MPRO Wall Outlet, Single Mode Handset and Hose. To see our full range visit [www.crosswater.co.uk](http://www.crosswater.co.uk)

- 8mm toughened glass
- 15mm adjustment each side
- 2000mm enclosure height
- Power shower proof
- Reversible design
- Outward opening door
- Matt Black finish frame
- Wet room compatible
- Easy Clean - Crosswater Clear as standard
- Lifetime Guarantee
- Concealed profile fixings

Width	Door Entry Width	Adjustment	Product Code	PRICE (£)
<b>Pivot Door with Side Panel</b>				
800x800mm	695	770 - 785	HPDBC0800/HSPSB0800	<b>NEW</b> £1,545.00
900x900mm	795	870 - 885	HPDBC0900/HSPSB0900	<b>NEW</b> £1,580.00
1000x1000mm	795	970 - 985	HPDBC1000/HSPSB1000	<b>NEW</b> £1,620.00

For wet room solutions, see page 128.  
Available July 2019.

Can only be installed with a side panel.

# Design+ Matt Black with Hush Technology - Pivot Door with Inline & Side Panel

NEW

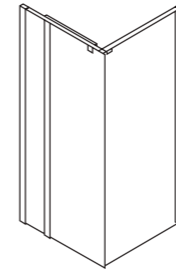

Pivot Door with Inline & Side Panel

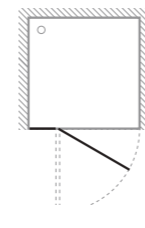

Door opening



Shown right: 25mm Linear Tray 900x900, MPRO Shower Head and Shower Arm, MPRO Wall Outlet, Single Mode Handset and Hose. To see our full range visit [www.crosswater.co.uk](http://www.crosswater.co.uk)

- 8mm toughened glass
- 15mm adjustment each side
- 2000mm enclosure height
- Power shower proof
- Reversible design
- Outward opening door
- Matt Black finish frame
- Wet room compatible
- Easy Clean - Crosswater Clear as standard
- Lifetime Guarantee
- Concealed profile fixings

Width	Door Entry Width	Adjustment	Product Code	PRICE (£)
<b>Pivot Door with Inline &amp; Side Panel</b>				
800x800mm	508	770 - 785	HHDBC0800/HSPSB0800	<b>NEW</b> £1,595.00
900x900mm	558	870 - 885	HHDBC0900/HSPSB0900	<b>NEW</b> £1,630.00
1000x1000mm	558	970 - 985	HHDBC1000/HSPSB1000	<b>NEW</b> £1,670.00

For wet room solutions, see page 128.  
Available July 2019.

Can only be installed with a side panel.



# Design+

## Design evolved

*Design+ is an evolution of the hugely popular Design collection adding thinner profiles and shorter bracing bars to create cleaner more minimal enclosure design options.*

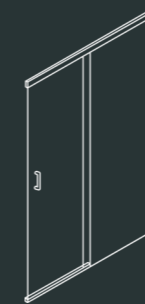

Soft Close Slider  
22

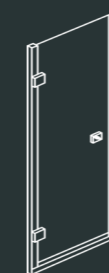

Hinged Door  
23



Hinged Door with  
Inline Panel  
24



Walk-In Panel  
25

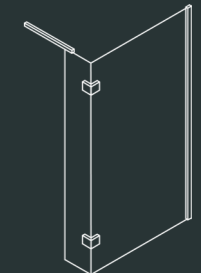

Two Sided Walk-In  
Enclosure  
26

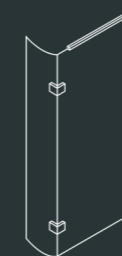

Walk-In Easy Access  
27

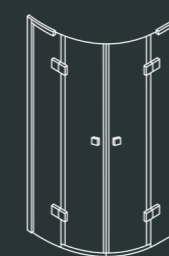

Quadrant Double  
Hinged Door  
28

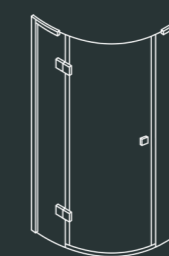

Quadrant Single  
Hinged Door  
29

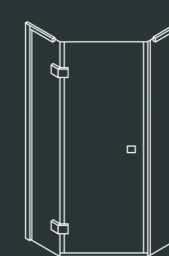

Pentagon Enclosure  
30



# Design+ - Soft Close Single Slider

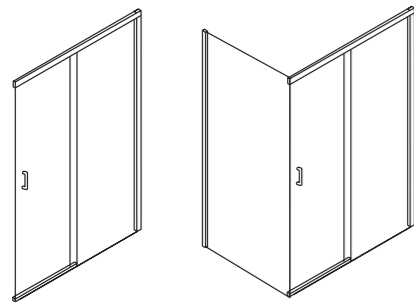

Soft Close Single Slider    Soft Close Single Slider with Side Panel

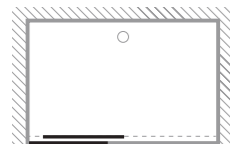

Door opening



Shown right: 1200mm Door, 1200 x 800mm Shower Tray, Kai Lever Shower Valve, Central Shower Head, Rex Ceiling Shower Arm, Ethos Shower Kit. To see our full range visit [www.crosswater.co.uk](http://www.crosswater.co.uk)



# Design+ - Hinged Door

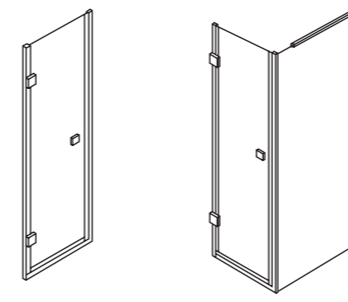

Hinged Door    Hinged Door with Side Panel

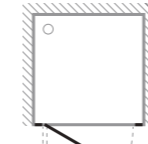

Door opening

Shown right: 25mm 900 x 900 Shower Tray, 900 Door and Side Panel, Glide Shower Head, Water Square Thermo Valve WS170IRC. To see our full range visit [www.crosswater.co.uk](http://www.crosswater.co.uk)



8mm toughened glass	25mm adjustment for easy fitting	1950mm enclosure height
Power shower proof	Reversible design	Sliding door
Silver finish frame	Wet room compatible	Easy Clean - Crosswater Clear as standard
Lifetime Guarantee	Soft & quiet door opening and closing	Concealed profile fixings
Quick release	Squeeze gasket installation	

Width	Door Entry Width	Adjustment	Product Code	PRICE (£)
<b>Soft Close Single Slider</b>				
1100mm	439	1060 - 1085 (1070 - 1095*)	DSLSC1100	£640.00
1200mm	489	1160 - 1185 (1170 - 1195*)	DSLSC1200	£650.00
1400mm	589	1360 - 1385 (1370 - 1395*)	DSLSC1400	£680.00
1600mm	689	1560 - 1585 (1570 - 1595*)	DSLSC1600	£755.00
1700mm	739	1660 - 1685 (1670 - 1695*)	DSLSC1700	£765.00
<b>Side Panel</b>				
800mm	N/A	775 - 785	DSLSP0800	£280.00
900mm	N/A	875 - 885	DSLSP0900	£295.00
1000mm	N/A	975 - 985	DSLSP1000	£315.00

### Optional

For uneven surfaces such as mosaic tiles a wall channel is available. DSLADJPROFILE £55.00

For additional sundries, please see page 90.

**This enclosure requires a shower tray with a minimum ledge of 60mm.**

**\*Adjustment when used with a side panel.**

For wet room solutions, see page 128.

8mm toughened glass	10mm adjustment for easy fitting	1950mm enclosure height
Power shower proof	Chrome plated hinges	Wet room compatible
Easy Clean - Crosswater Clear as standard	Lifetime Guarantee	Self closing hinges
Concealed profile fixings	Squeeze gasket installation	

Width	Door Entry Width	Adjustment	Product Code	PRICE (£)
<b>Hinged Door</b>				
800mm	720	780-790, 769*	DWHSC0800L	£525.00
800mm	720	780-790, 769*	DWHSC0800R	£525.00
900mm	820	880-890, 869*	DWHSC0900L	£545.00
900mm	820	880-890, 869*	DWHSC0900R	£545.00

For additional sundries, please see page 90.

**\*Fixed width when used with a side panel. For side panels see page 24.**

For wet room solutions, see page 128.

# Design+ - Hinged Door with Inline Panel

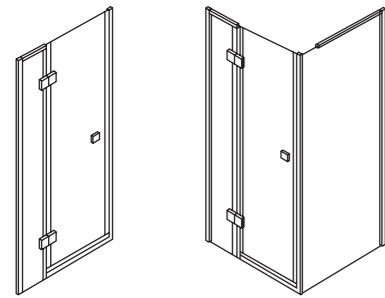

Hinged Door with Inline Panel

Hinged Door with Inline Panel & Side Panel

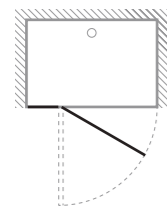

Door opening



Shown right: 1200 Hinged Door, 25mm Linear Tray, MPRO Shower Head. To see our full range visit [www.crosswater.co.uk](http://www.crosswater.co.uk)

# Design+ - Walk-In Panel

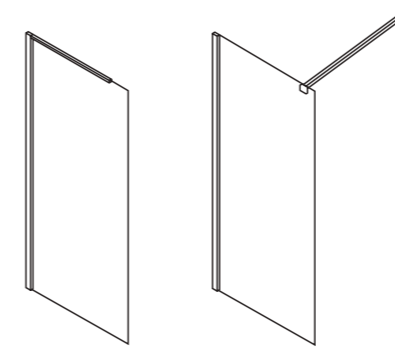

Walk-In Panel (300 - 1000mm)

Walk-In Panel (1100 - 1400mm)

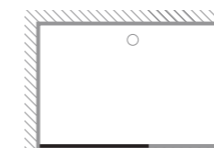

Door opening

## Return panel

The return panel is designed to be used alongside the walk-in panel to reduce water spray outside of the shower area.

Width 200mm  
DEPSC0200+ £245.00

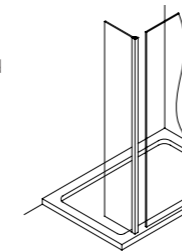

Shown right: 25mm linear tray 1700 x 800, 1200 panel, MPRO Shower Head, 1000 Thermostatic Valve. To see our full range visit [www.crosswater.co.uk](http://www.crosswater.co.uk)



6mm (door) 8mm (fixed panel) toughened glass	25mm adjustment for easy fitting	1950mm enclosure height
Power shower proof	Reversible design	Outward opening door
Silver finish frame	Wet room compatible	Easy Clean - Crosswater Clear as standard
Lifetime Guarantee	Concealed profile fixings	

Width	Door Entry Width	Adjustment	Product Code	PRICE (£)
<b>Hinged Door with Inline Panel</b>				
700mm	440	670 - 695 (656 - 671*)	DHDSC0700+	£595.00
760mm	500	730 - 755 (716 - 731*)	DHDSC0760+	£615.00
800mm	540	770 - 795 (756 - 771*)	DHDSC0800+	£645.00
900mm	590	870 - 895 (856 - 871*)	DHDSC0900+	£675.00
1000mm	590	970 - 995 (956 - 971*)	DHDSC1000+	£725.00
1100mm	640	1070 - 1095 (1056 - 1071*)	DHDSC1100+	£765.00
1200mm	640	1170 - 1195 (1156 - 1171*)	DHDSC1200+	£785.00
<b>Side Panel</b>				
700mm	N/A	675 - 690	DSPSC0700+	£305.00
760mm	N/A	735 - 750	DSPSC0760+	£310.00
800mm	N/A	775 - 790	DSPSC0800+	£330.00
900mm	N/A	875 - 890	DSPSC0900+	£350.00
1000mm	N/A	975 - 990	DSPSC1000+	£465.00
1100mm	N/A	1075 - 1090	DSPSC1100+	£515.00
1200mm	N/A	1175 - 1190	DSPSC1200+	£545.00
1400mm	N/A	1375 - 1390	DSPSC1400+	£565.00

For additional sundries, please see page 90.

For improved stability, the 1100 - 1400mm side panels are supplied with a 90° bracing bar.

\*Adjustment when used with a side panel.

For wet room solutions, see page 128.

8mm toughened glass	15mm adjustment for easy fitting	1950mm enclosure height
Power shower proof	Reversible design	Silver finish frame
Wet room compatible	Easy Clean - Crosswater Clear as standard	Lifetime Guarantee
Concealed profile fixings		

Width	Door Entry Width	Adjustment	Product Code	PRICE (£)
<b>Walk-In Panel</b>				
300mm	N/A	242 - 257	DSPSC0300+	£260.00
400mm	N/A	342 - 357	DSPSC0400+	£260.00
500mm	N/A	442 - 457	DSPSC0500+	£270.00
600mm	N/A	542 - 557	DSPSC0600+	£290.00
700mm	N/A	642 - 657	DSPSC0700+	£305.00
760mm	N/A	702 - 717	DSPSC0760+	£310.00
800mm	N/A	742 - 757	DSPSC0800+	£330.00
900mm	N/A	842 - 857	DSPSC0900+	£350.00
1000mm	N/A	942 - 957	DSPSC1000+	£465.00
1100mm	N/A	1042 - 1057	DSPSC1100+	£515.00
1200mm	N/A	1142 - 1157	DSPSC1200+	£545.00
1400mm	N/A	1342 - 1357	DSPSC1400+	£565.00

For additional sundries, please see page 90.

For improved stability, the 1100 - 1400mm walk-in panels are supplied with a 90° angled bracket

Price per Walk-In panel.

For wet room solutions, see page 128.

# Design+ - Two Sided Walk-In Enclosure

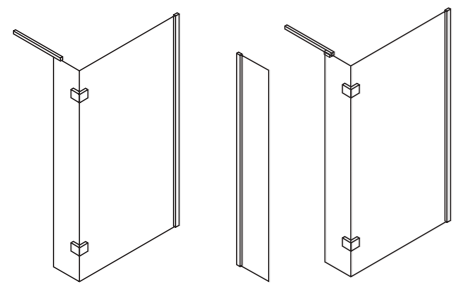

Two Sided Walk-In Enclosure  
Two Sided Walk-In Enclosure with Walk-In End Panel

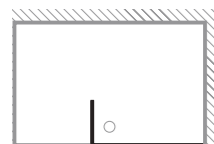

Door opening



Shown right: 1700 x 800mm (R/H) Enclosure with 550mm End Panel. 800 x 1700mm Shower Tray. High Flow Shower Waste. Kai Lever Shower Valve. Central Shower Head. Rex Ceiling Shower Arm. To see our full range visit [www.crosswater.co.uk](http://www.crosswater.co.uk)



# Design+ - Walk-In Easy Access

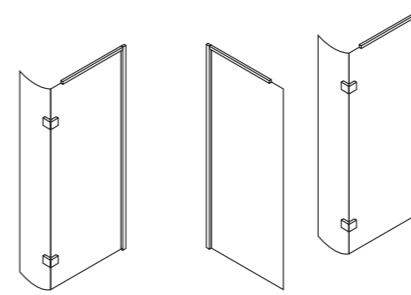

Walk-In Easy Access  
Walk-In Easy Access with Walk-In End Panel

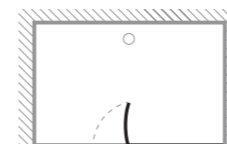

Door opening

Shown right: 1400 x 800 25mm Linear Tray, MPRO Shower Head and MPRO Thermostatic Valve. To see our full range visit [www.crosswater.co.uk](http://www.crosswater.co.uk)



- 8mm toughened glass
- 15mm adjustment for easy fitting
- 1950mm enclosure height
- Power shower proof
- Reversible design
- Silver finish frame
- Easy Clean - Crosswater Clear as standard
- Lifetime Guarantee
- Tray mounted only

Width	Door Entry Width	Adjustment	Product Code	PRICE (£)
<b>Two Sided Walk-In Enclosure</b>				
1400 x 900mm	542	805 - 820	DWDSC1400+	£605.00
318 (return panel)				
1700 x 800mm	542	1105 - 1120	DWDSC1700+	£710.00
218 (return panel)				
<b>Walk-In End Panel</b>				
550mm	N/A	551 - 566	DWKSC0550+	£305.00

For additional sundries, please see page 90.

**Enclosure must be used in conjunction with walk-in trays STWK91400 and STWK81700.**

- 8mm toughened glass
- 15mm adjustment for easy fitting
- 1950mm enclosure height
- Power shower proof
- Reversible design
- Silver finish frame
- Wet room compatible
- Easy Clean - Crosswater Clear as standard
- Lifetime Guarantee
- Concealed profile fixings

Width	Door Entry Width	Adjustment	Product Code	PRICE (£)
<b>Walk-In Easy Access</b>				
1400mm	670	1000 - 1015	DWQSC1400+	£585.00
700mm (fixed panel)				
300mm (return panel)				
1700mm	770	1200 - 1215	DWQSC1700+	£685.00
900mm (fixed panel)				
300mm (return panel)				
<b>Walk-In End Panel</b>				
300mm	N/A	242 - 257	DSPSC0300+	£260.00
400mm	N/A	342 - 357	DSPSC0400+	£260.00
500mm	N/A	442 - 457	DSPSC0500+	£270.00
600mm	N/A	542 - 557	DSPSC0600+	£290.00
700mm	N/A	642 - 657	DSPSC0700+	£305.00
760mm	N/A	702 - 717	DSPSC0760+	£310.00
800mm	N/A	742 - 757	DSPSC0800+	£330.00
900mm	N/A	842 - 857	DSPSC0900+	£350.00

For additional sundries, please see page 90.

Price per Walk-In panel.

For wet room solutions, see page 128.



# Design+ - Quadrant Double Hinged Door

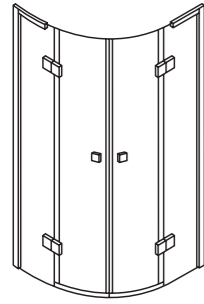

Semi-Frameless Quadrant Double Hinged Door

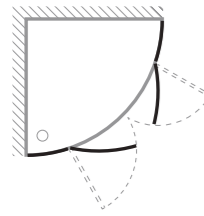

Door opening



Shown right: 900 x 900mm Enclosure. 900 x 900mm Shower Tray. Watersquare Shower Valve. Zion Shower Head. To see our full range visit [www.crosswater.co.uk](http://www.crosswater.co.uk)

# Design+ - Quadrant Single Hinged Door

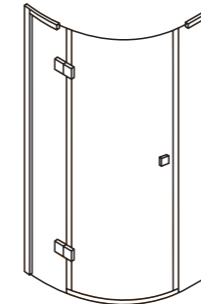



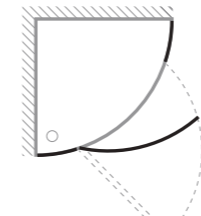









Semi-Frameless Quadrant Single Hinged Door



Door opening



Shown right: 1200 x 800mm Enclosure. 1200 x 800mm Shower Tray. Design Multifunction Thermostatic Shower Valve. To see our full range visit [www.crosswater.co.uk](http://www.crosswater.co.uk)

-  6mm (door) 8mm (fixed panel) toughened glass
-  15mm adjustment for easy fitting
-  1950mm enclosure height
-  Power shower proof
-  Outward opening door
-  Magnet closing
-  Silver finish frame
-  Wet room compatible
-  Easy Clean - Crosswater Clear as standard
-  Lifetime Guarantee
-  To suit a Crosswater 550mm radius shower tray
-  Concealed profile fixings













Width	Door Entry Width	Adjustment	Product Code	PRICE (£)
<b>Quadrant Double Hinged Door</b>				
800mm	650	770 - 785	DQDSC0800+	£669.00
900mm	650	870 - 885	DQDSC0900+	£699.00

For additional sundries, please see page 90.  
For wet room solutions, see page 128.

**recessed or exposed?**

*Not sure which shower valve to opt for? Browse our collection for a choice of both recessed and exposed styles.*

*See the Premium Brassware brochure for more information.*

-  6mm (door) 8mm (fixed panel) toughened glass
-  15mm adjustment for easy fitting
-  1950mm enclosure height
-  Power shower proof
-  Reversible design
-  Outward opening door
-  Magnet closing
-  Silver finish frame
-  Wet room compatible
-  Easy Clean - Crosswater Clear as standard
-  Lifetime Guarantee
-  To suit a Crosswater 550mm radius shower tray
-  Concealed profile fixings

Width	Door Entry Width	Adjustment	Product Code	PRICE (£)
<b>Quadrant Single Hinged Door</b>				
800mm	650	770 - 785	DQSSC0800+	£689.00
900mm	650	870 - 885	DQSSC0900+	£739.00
1000mm	650	970 - 985	DQSSC1000+	£789.00
1000 x 800mm	650	770 - 785 x 970 - 985	DQSSC10X8+	£789.00
1200 x 800mm	650	770 - 785 x 1170 - 1185	DQSSC12X8+	£829.00
1200 x 900mm	650	870 - 885 x 1170 - 1185	DQSSC12X9+	£839.00

For additional sundries, please see page 90.

**Door will be hinged off the smaller panel for all offset quadrants.**

For wet room solutions, see page 128.



# Design+ - Pentagon Enclosure

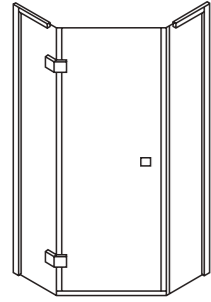

Semi-Frameless  
Pentagon Enclosure

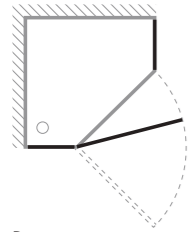

Door opening

Shown right: 900 x 900mm Enclosure. 900 x 900mm Shower Tray. Water Square Shower Valve. Zion Shower Head. To see our full range visit [www.crosswater.co.uk](http://www.crosswater.co.uk)



- 6mm (door) 8mm (fixed panel) toughened glass
- 15mm adjustment for easy fitting
- 1950mm enclosure height

- Power shower proof
- Reversible design
- Outward opening door

- Magnet closing
- Silver finish frame
- Wet room compatible

- Easy Clean - Crosswater Clear as standard
- Lifetime Guarantee

Width	Door Entry Width	Adjustment	Product Code	PRICE (£)
<b>Pentagon Enclosure</b>				
900 x 900mm	665	875 - 890	DPTSC0900+	£905.00

For additional sundries, please see page 90.  
For wet room solutions, see page 128.

pentagon  
shower  
trays

*We've got a range of shower trays that are designed to fit the unique shape of your Pentagon shower enclosure.*

*See the Crosswater Essentials brochure or website for more information.*

crosswater

MPRO



now available in four  
exquisite finishes

SEE THE PREMIUM BRASSWARE BROCHURE FOR MORE DETAILS.





NEW

# Svelte

*Our premium shower range, Svelte offers a statement showering solution to your bathroom.*



*All Svelte enclosures are supplied with a clear glass open design to create a minimal design statement. Additionally, an easy to fit clip on chrome handle is supplied in the box.*



Single Slider  
34

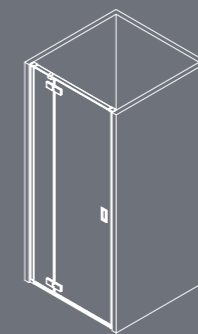

Hinged Door with  
Inline Panel 35

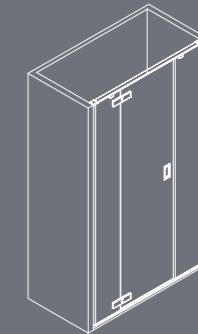

Hinged Door with  
Two Inline Panels 35

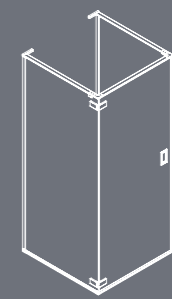

Three Sided  
Hinged Door 36



Wall Mounted  
Hinged Door 37

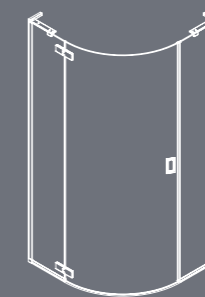

Quadrant Single  
Door 38



Walk-In  
39



# Svelte - Single Slider

NEW

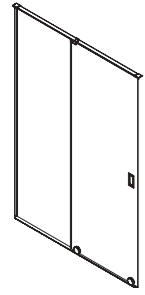

Single Slider

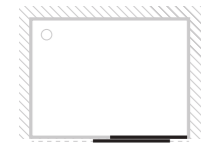

Door opening



Shown right: Single Slider in recess, 25mm Shower Tray, Essence Shower Head, Svelte Shower Valve. To see our full range visit [www.crosswater.co.uk](http://www.crosswater.co.uk)

# Svelte - Hinged Door

NEW

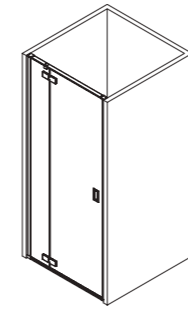

Hinged Door with Inline panel

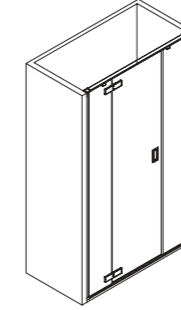

Hinged Door with Two Inline Panels (1400 Recess only)

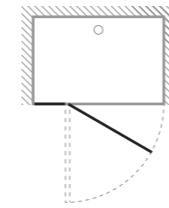

Door opening

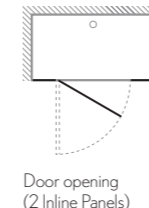

Door opening (2 Inline Panels) Recess only



Shown right: Hinged Door with Inline Panel and Side Panel, 25mm Shower Tray, Essence Shower Head, Svelte Shower Valve. To see our full range visit [www.crosswater.co.uk](http://www.crosswater.co.uk)

8mm toughened glass	30mm adjustment for easy fitting	2000mm enclosure height
Power shower proof	Reversible design	Frameless sliding door
Polished stainless steel frame	Wet room compatible	Easy Clean - Crosswater Clear as standard
Lifetime Guarantee	Concealed profile fixings	Squeeze gasket installation

Width	Door Entry Width	Adjustment	Product Code	PRICE (£)
<b>Single Slider</b>				
1200mm	475	1165-1195 (1170-1185*)	SSLSC1200	<b>NEW</b> £1,095.00
1400mm	575	1365-1395 (1370-1385*)	SSLSC1400	<b>NEW</b> £1,195.00
1700mm	725	1665-1695 (1670-1685*)	SSLSC1700	<b>NEW</b> £1,295.00
<b>Required when using a Side Panel</b>				
			Svelte Slider/Side Panel seal	SLSPSEAL <b>NEW</b> £15.00
			Svelte Side Panel bracing bar	SPBRACE <b>NEW</b> £75.00
<b>Side Panel</b>				
700mm	N/A	670-685	SSPSC0700	<b>NEW</b> £335.00
800mm	N/A	770-785	SSPSC0800	<b>NEW</b> £360.00
900mm	N/A	870-885	SSPSC0900	<b>NEW</b> £385.00
1000mm	N/A	970-985	SSPSC1000	<b>NEW</b> £410.00
1200mm	N/A	1170-1185	SSPSC1200	<b>NEW</b> £435.00

\*Adjustment when used with a side panel.

For shower tray options, see page 114.

8mm toughened glass	25mm adjustment for easy fitting	2000mm enclosure height
Power shower proof	Reversible design	Outward opening door
Polished stainless steel frame	Wet room compatible	Easy Clean - Crosswater Clear as standard
Lifetime Guarantee	Concealed profile fixings	Squeeze gasket installation

Width	Door Entry Width	Adjustment	Product Code	PRICE (£)
<b>Hinged Door</b>				
800mm	527	770-795 (770-785*)	SHDSC0800	<b>NEW</b> £895.00
900mm	577	870-895 (870-885*)	SHDSC0900	<b>NEW</b> £995.00
1000mm	627	970-995 (970-985*)	SHDSC1000	<b>NEW</b> £1,095.00
1200mm	627	1170-1195 (1170-1185*)	SHDSC1200	<b>NEW</b> £1,195.00
<b>Hinged Door - recess only (30mm adjustment)</b>				
1400mm	645	1370-1400	SHDSC1400	<b>NEW</b> £1,295.00
<b>Required when using a Side Panel (not compatible with SHDSC1400)</b>				
			Svelte Hinged/Side Panel seal	HDSPSEAL <b>NEW</b> £15.00
			Svelte Side Panel bracing bar	SPBRACE <b>NEW</b> £75.00
<b>Side Panel</b>				
700mm	N/A	670-685	SSPSC0700	<b>NEW</b> £335.00
800mm	N/A	770-785	SSPSC0800	<b>NEW</b> £360.00
900mm	N/A	870-885	SSPSC0900	<b>NEW</b> £385.00
1000mm	N/A	970-985	SSPSC1000	<b>NEW</b> £410.00
1200mm	N/A	1170-1185	SSPSC1200	<b>NEW</b> £435.00

\*Adjustment when used with a side panel.

For wet room solutions, see page 128.



# Svelte - Three Sided Hinged Door

NEW

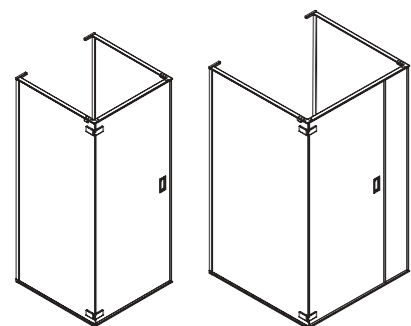

Three Sided Hinged Door (900)      Three Sided Hinged Door (1000)

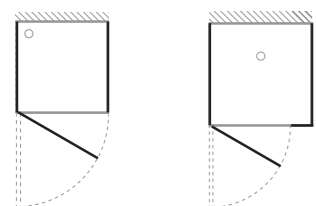

Door opening (900)      Door opening (1000)



Shown right: Three Sided Hinged Door (1000), 25mm Shower Tray, Essence Shower Head, Svelte Shower Valve. To see our full range visit [www.crosswater.co.uk](http://www.crosswater.co.uk)

8mm toughened glass	15mm per panel adjustment for easy fitting	2000mm enclosure height
Power shower proof	Reversible design	Outward opening door
Polished stainless steel frame	Wet room compatible	Easy Clean - Crosswater Clear as standard
Lifetime Guarantee	Concealed profile fixings	Squeeze gasket installation

Width	Door Entry Width	Adjustment	Product Code	PRICE (£)
<b>Three Sided Hinged Door</b>				
900mm	880	870-885*	STSSC0900	<b>NEW</b> £1,675.00
1000mm	700	870-885*	STSSC1000	<b>NEW</b> £1,725.00

\*Adjustments are for side panels only.

For 900mm three sided hinged door, use 900x900mm tray.  
For 1000mm three sided hinged door, use 1000x900mm tray.

matching valves

Complement with Svelte shower valves. See the Premium Brassware brochure for more information.

# Svelte - Wall Mounted Hinged Door

NEW



Wall Mounted Hinged Door

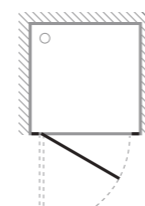

Door opening



Shown right: Wall Mounted Hinged Door, 25mm Shower Tray, Essence Shower Head, Svelte Shower Valve. To see our full range visit [www.crosswater.co.uk](http://www.crosswater.co.uk)

8mm toughened glass	10mm adjustment for easy fitting	Height 1985, 2000 when used with a side panel
Power shower proof	Reversible design	Outward opening door
Polished stainless steel frame	Wet room compatible	Easy Clean - Crosswater Clear as standard
Lifetime Guarantee	Concealed profile fixings	Squeeze gasket installation

Width	Door Entry Width	Adjustment	Product Code	PRICE (£)
<b>Wall Mounted Hinged Door</b>				
800mm	770	770-780 (770*)	SWHSC0800	<b>NEW</b> £695.00
900mm	870	870-880 (870*)	SWHSC0900	<b>NEW</b> £755.00

### Required when using Side Panel with Hinged Door.

Svelte Hinged Door/Side panel seal	HDSPSEAL	<b>NEW</b> £15.00
Svelte Side Panel bracing bar	SPBRACE	<b>NEW</b> £75.00
Svelte bracing bar Wall Mount Door and Side	WSBRACE	<b>NEW</b> £55.00

### Side Panel

700mm	N/A	670-685	SSPSC0700	<b>NEW</b> £335.00
800mm	N/A	770-785	SSPSC0800	<b>NEW</b> £360.00
900mm	N/A	870-885	SSPSC0900	<b>NEW</b> £385.00
1000mm	N/A	970-985	SSPSC1000	<b>NEW</b> £410.00
1200mm	N/A	1170-1185	SSPSC1200	<b>NEW</b> £435.00

\*Fixed width when used with a side panel.

For wet room solutions, see page 128.



# Svelte - Quadrant Single Door

NEW

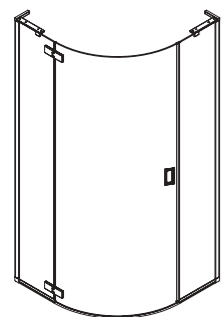

Quadrant Single Door

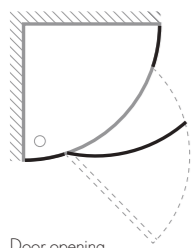

Door opening



Shown right: Quadrant Single Door, 25mm Shower Tray, Essence Shower Head, Svelte Shower Valve. To see our full range visit [www.crosswater.co.uk](http://www.crosswater.co.uk)

- 8mm toughened glass
- 15mm per panel adjustment for easy fitting
- 2000mm enclosure height
- Power shower proof
- Reversible design
- Outward opening door
- Polished stainless steel frame
- Wet room compatible
- Easy Clean - Crosswater Clear as standard
- Lifetime Guarantee
- Concealed profile fixings
- Squeeze gasket installation
- Magnet closing
- To suit a Crosswater 55mm radius shower tray

Width	Door Entry Width	Adjustment	Product Code	PRICE (£)
<b>Quadrant Single Door</b>				
800mm	732	770-785	SQSSC0800	<b>NEW</b> £1120.00
900mm	732	870-885	SQSSC0900	<b>NEW</b> £1,250.00
1000mm	732	970-985	SQSSC1000	<b>NEW</b> £1,320.00
1000x800mm	732	970-985 x 770-785	SQSSC10X8	<b>NEW</b> £1,220.00

matching valves

Complement with Svelte shower valves. See the Premium Brassware brochure for more information.

# Svelte - Walk-In Panel

NEW

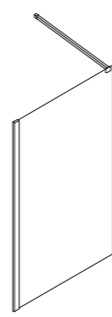

Recess

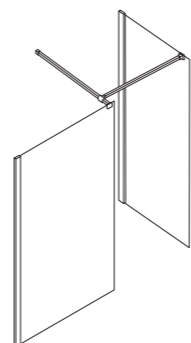

Corner with End Panel



Opening (Recess)

Opening (Corner with End Panel)

Shown right: Walk-In Panel, 25mm Shower Tray, Essence Shower Head, Svelte Shower Valve. To see our full range visit [www.crosswater.co.uk](http://www.crosswater.co.uk)

- 8mm toughened glass
- 15mm adjustment for easy fitting
- 1982mm enclosure height
- Power shower proof
- Reversible design
- Easy Clean - Crosswater Clear as standard
- Polished stainless steel frame
- Wet room compatible
- Lifetime Guarantee
- Concealed profile fixings
- Squeeze gasket installation



Width	Door Entry Width	Adjustment	Product Code	PRICE (£)
<b>Walk-In Panel</b>				
700mm	N/A	650-665	SSPSC0700	<b>NEW</b> £335.00
800mm	N/A	750-765	SSPSC0800	<b>NEW</b> £360.00
900mm	N/A	850-865	SSPSC0900	<b>NEW</b> £385.00
1000mm	N/A	950-965	SSPSC1000	<b>NEW</b> £410.00
1200mm	N/A	1150-1165	SSPSC1200	<b>NEW</b> £435.00

### Required sundries

Svelte Walk-In bracing bar for use in a recess	WIBRACE	<b>NEW</b> £90.00
T Shape bracing bar for corner use	PI0000030	<b>NEW</b> £85.00





NEW

# Infinity

*The Infinity showering range features polished stainless steel profiles, presenting you with a simple and clean design aesthetic.*



Single Slider  
42



Hinged Door  
43



Pivot Door  
44

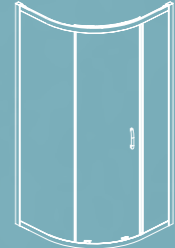

Quadrant Single Door  
45

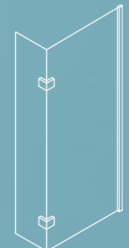

Walk-In  
46



# Infinity - Soft Close Single Slider

NEW

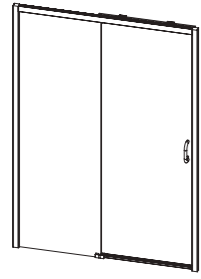



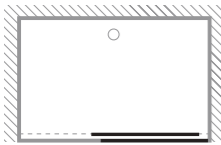









Single Slider



Door opening



Shown right: Soft Close Single Slider with Side Panel, MPRO Shower Head, Wall Mounted Shower Arm, 1000 Shower Valve. To see our full range visit [www.crosswater.co.uk](http://www.crosswater.co.uk)

-   
8mm (door)  
8mm (fixed panel)  
toughened glass
-   
40mm  
adjustment for  
easy fitting
-   
2000mm  
enclosure height
-   
Power shower  
proof
-   
Reversible  
design
-   
Frameless  
sliding door
-   
Polished stainless  
steel frame
-   
Wet room  
compatible
-   
Easy Clean -  
Crosswater Clear  
as standard
-   
Lifetime  
Guarantee
-   
Quick release  
mechanism
-   
Soft & quiet  
door opening  
and closing

Width	Door Entry Width	Adjustment	Product Code	PRICE (£)
<b>Soft Close Single Slider</b>				
1200mm	479	1170-1210 (1170-1190*)	ISLSC1200	<b>NEW</b> £975.00
1400mm	579	1370-1410 (1370-1390*)	ISLSC1400	<b>NEW</b> £1,035.00
1700mm	729	1670-1710 (1670-1690*)	ISLSC1700	<b>NEW</b> £1,095.00
<b>Side Panel</b>				
800mm	N/A	770-790	ISPSC0800	<b>NEW</b> £515.00
900mm	N/A	870-890	ISPSC0900	<b>NEW</b> £525.00

\*Adjustment when used with a side panel.

For wet room solutions, see page 128.

# Infinity - Hinged Door

NEW

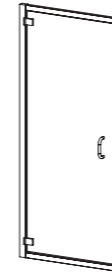



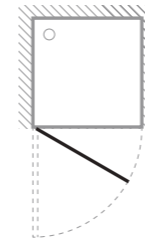







Hinged Door



Door opening



Shown right: Hinged Door in recessed setting, MPRO Shower Head, Wall Mounted Shower Arm, 1000 Shower Valve. To see our full range visit [www.crosswater.co.uk](http://www.crosswater.co.uk)

-   
8mm  
toughened  
glass
-   
40mm  
adjustment for  
easy fitting
-   
2000mm  
enclosure height
-   
Power shower  
proof
-   
Reversible  
design
-   
Outward  
opening door
-   
Ball catch  
closing
-   
Polished stainless  
steel frame
-   
Wet room  
compatible
-   
Easy Clean -  
Crosswater Clear  
as standard
-   
Lifetime  
Guarantee

Width	Door Entry Width	Adjustment	Product Code	PRICE (£)
<b>Hinged Door</b>				
800mm	678	770-810 (770-790*)	IHDSC0800	<b>NEW</b> £745.00
900mm	778	870-910 (870-890*)	IHDSC0900	<b>NEW</b> £775.00
<b>Side Panel</b>				
800mm	N/A	770-790	ISPSC0800	<b>NEW</b> £515.00
900mm	N/A	870-890	ISPSC0900	<b>NEW</b> £525.00

\*Adjustment when used with a side panel.

For wet room solutions, see page 128.



# Infinity - Pivot Door

NEW

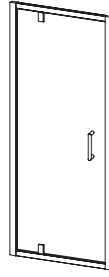

Pivot Door

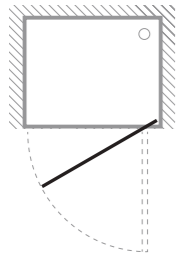

Door opening



Shown right: Pivot Door with Side Panel, MPRO Shower Head, Wall Mounted Shower Arm, 1000 Shower Valve. To see our full range visit [www.crosswater.co.uk](http://www.crosswater.co.uk)

-  8mm toughened glass
-  40mm adjustment for easy fitting
-  2000mm enclosure height
-  Power shower proof
-  Reversible design
-  Outward opening door
-  Polished stainless steel frame
-  Wet room compatible
-  Easy Clean - Crosswater Clear as standard
-  Lifetime Guarantee
-  Ball catch closing

Width	Door Entry Width	Adjustment	Product Code	PRICE (£)
<b>Pivot Door</b>				
900mm	638	870-910 (870-890*)	IPDSC0900	<b>NEW</b> £730.00
<b>Side Panel</b>				
800mm	N/A	770-790	ISPSC0800	<b>NEW</b> £515.00
900mm	N/A	870-890	ISPSC0900	<b>NEW</b> £525.00

\*Adjustment when used with a side panel.

For wet room solutions, see page 128.

# Infinity - Quadrant Single Door

NEW

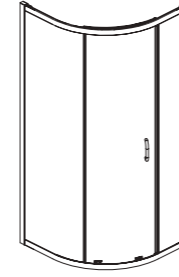

Quadrant Single Door

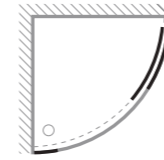

Door opening



Shown right: Quadrant Single Door, MPRO Shower Head, Wall Mounted Shower Arm, 1000 Shower Valve. To see our full range visit [www.crosswater.co.uk](http://www.crosswater.co.uk)

-  8mm (door) 8mm (fixed panel) toughened glass
-  20mm per panel adjustment for easy fitting
-  2000mm enclosure height
-  Power shower proof
-  Reversible design
-  Frameless sliding door
-  Polished stainless steel frame
-  Wet room compatible
-  Easy Clean - Crosswater Clear as standard
-  Lifetime Guarantee
-  Quick release rollers

Width	Door Entry Width	Adjustment	Product Code	PRICE (£)
<b>Quadrant Single Door</b>				
900mm	475	870-890	IQSSC0900	<b>NEW</b> £995.00
1000x800mm	475	970-990 x 770-790	IQSSC10X8	<b>NEW</b> £1,095.00
1200x800mm	475	1170-1190 x 770-790	IQSSC12X8	<b>NEW</b> £1,095.00
1200x900mm	475	1170-1190 x 870-890	IQSSC12X9	<b>NEW</b> £1,095.00



# Infinity - Walk-In with Deflector Panel

NEW

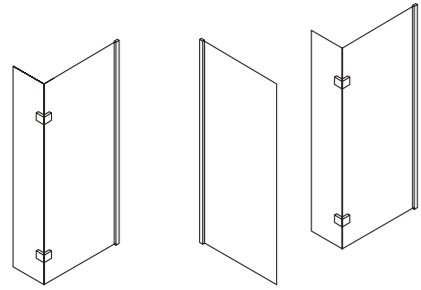

Walk-In with Deflector Panel

Walk-In with Deflector and End Panel

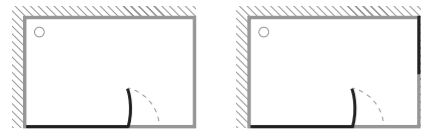



Opening (Recess)

Opening (Corner with End Panel)



Shown right: Walk-In Panel, MPRO Shower Head, Wall Mounted Shower Arm, 1000 Shower Valve. To see our full range visit [www.crosswater.co.uk](http://www.crosswater.co.uk)

-  8mm toughened glass
-  15mm adjustment for easy fitting
-  2000mm enclosure height
-  Power shower proof
-  Reversible design
-  Polished stainless steel finish
-  Wet room compatible
-  Easy Clean - Crosswater Clear as standard
-  Lifetime Guarantee
-  Folding panel for easy access (90° hinge)
-  Concealed profile fixings
-  Squeeze gasket installation

Width	Door Entry Width	Adjustment	Product Code	PRICE (£)
<b>Walk-In with Deflector Panel</b>				
1035mm		1035-1055	IWESC1050	<b>NEW</b> £695.00
1235mm		1235-1255	IWESC1250	<b>NEW</b> £745.00
1435mm		1435-1455	IWESC1450	<b>NEW</b> £795.00
<b>Walk-In End Panel</b>				
550mm		550-570	IWKSC0550	<b>NEW</b> £285.00

crosswater<sup>x</sup>

# INFINITY



Crosswater presents the Infinity collection, comprising of furniture, ceramic and showering solutions for your bathroom, for more details see the Premium Furniture & Ceramics brochure or visit [www.crosswater.co.uk](http://www.crosswater.co.uk)







# Zion

*A deluxe range of 10mm enclosures and walk-in panels, combining a frameless design with stainless steel detailing.*



Hinged Door  
50



Hinged Door with Inline  
& Fixed Panel  
51



Walk-In Panel  
52



# Zion - Hinged Door

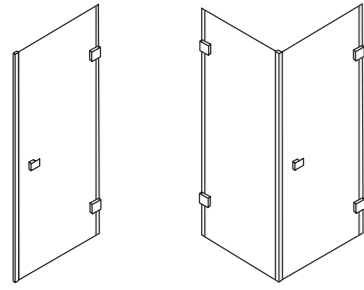

Hinged Door  
Hinged Door with Side Panel

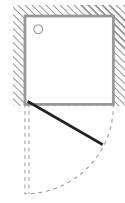

Door opening



Shown right: 900mm Door. 900 x 900 x 25mm Stone Resin Shower Tray. Zion Tap. Water Square Shower Valve. Zion Shower Head. Glide II Furniture. Avillas Basin. Dune Mirror. To see our full range visit [www.crosswater.co.uk](http://www.crosswater.co.uk)



# Zion - Hinged Door with Inline & Fixed Panel

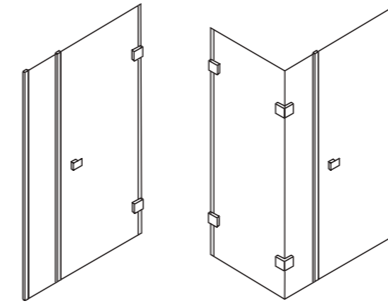

Hinged Door with Inline Panel  
Hinged Door with Inline Panel & Fixed Panel

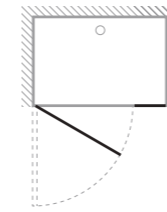

Door opening (1 Inline Panel)

Shown right: 1200mm Door. 1200 x 900 x 25mm Stone Resin Shower Tray. Zion Tap. Water Square Shower Valve. Zion Shower Head. Glide II Furniture. Avillas Basin. Dune Mirror. To see our full range visit [www.crosswater.co.uk](http://www.crosswater.co.uk)



- 10mm toughened glass
- 15mm adjustment for easy fitting
- 2000mm enclosure height
- Power shower proof
- Reversible design
- Outward opening door
- Magnet closing
- Chromed hinges
- Wet room compatible
- Easy Clean - Crosswater Clear as standard
- Lifetime Guarantee
- Squeeze gasket installation

Width	Door Entry Width	Adjustment	Product Code	PRICE (£)
<b>Hinged Door</b>				
800mm	730	780 - 795 (764mm*)	ZHDSC0800	£785.00
900mm	830	880 - 895 (864mm*)	ZHDSC0900	£825.00
<b>Side Panels</b>				
600mm	N/A	575 - 590	ZSPSC0600	£595.00
700mm	N/A	675 - 690	ZSPSC0700	£635.00
800mm	N/A	775 - 790	ZSPSC0800	£675.00
900mm	N/A	875 - 890	ZSPSC0900	£715.00
1000mm	N/A	975 - 990	ZSPSC1000	£755.00
1100mm	N/A	1075 - 1090	ZSPSC1100	£795.00
1200mm	N/A	1175 - 1190	ZSPSC1200	£835.00

\*Fixed width when used with a side panel. Wall hinges must be secured to a solid wall.  
For wet room solutions, see page 128.

- 10mm toughened glass
- 15mm adjustment for easy fitting
- 2000mm enclosure height
- Power shower proof
- Reversible design
- Outward opening door
- Magnet closing
- Chromed hinges
- Wet room compatible
- Easy Clean - Crosswater Clear as standard
- Lifetime Guarantee
- Squeeze gasket installation

Width	Door Entry Width	Adjustment	Product Code	PRICE (£)
<b>Hinged Door with Inline Panel</b>				
1000mm	730	970 - 985 (800 Door / 200 Panel)	ZHDSC0800/ZIPSCO200	£1,260.00
1100mm	730	1070 - 1085 (800 Door / 300 Panel)	ZHDSC0800/ZIPSCO300	£1,280.00
1100mm	830	1070 - 1085 (900 door / 200 Panel)	ZHDSC0900/ZIPSCO200	£1,300.00
1200mm	830	1170 - 1185 (900 door / 300 Panel)	ZHDSC0900/ZIPSCO300	£1,320.00
<b>Hinged Door with Inline Panel &amp; Fixed Panel</b>				
1200 x 800mm	830	775 - 790 (1175mm*)	ZHDSC0900/ZIPSCO300/ ZFPSC0800	£1,765.00

\*Fixed width when used with a fixed panel. Wall hinges must be secured to a solid wall.  
For wet room solutions, see page 128.



# Zion - Walk-In Panel

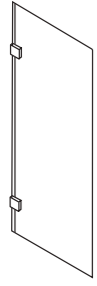

Walk-in panel

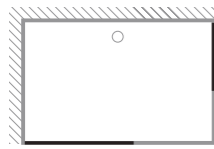

Door opening

Shown right: 1200mm Walk-In Panel. 1200 x 900mm Linear Stone Resin Shower Tray. Zion Tap. Water Square Shower Valve. Zion Shower Head. Glide II Furniture. Avillas Basin. Dune Illuminated Mirror. To see our full range visit [www.crosswater.co.uk](http://www.crosswater.co.uk)



-  10mm toughened glass
-  15mm adjustment for easy fitting
-  2000mm enclosure height
-  Power shower proof
-  Reversible design
-  Polished stainless steel finish
-  Wet room compatible
-  Easy Clean - Crosswater Clear as standard
-  Lifetime Guarantee
-  Concealed fixings
-  Squeeze gasket installation

Width	Door Entry Width	Adjustment	Product Code	PRICE (£)
<b>Walk-In Panel</b>				
600mm	N/A	575 - 590	ZSPSC0600	£595.00
700mm	N/A	675 - 690	ZSPSC0700	£635.00
800mm	N/A	775 - 790	ZSPSC0800	£675.00
900mm	N/A	875 - 890	ZSPSC0900	£715.00
1000mm	N/A	975 - 990	ZSPSC1000	£755.00
1100mm	N/A	1075 - 1090	ZSPSC1100	£795.00
1200mm	N/A	1175 - 1190	ZSPSC1200	£835.00

Price per Walk-In Panel. Walk-In Panels are all supplied with bracing bars. For wet room solutions, see page 12B.

**matching valves**

*Looking for the perfect partner to your Zion enclosure? Our range of contemporary shower valves will complete the look.*

*See the Premium Brassware brochure for more information.*



# Zion

the ultimate showering statement

SEE THE PREMIUM BRASSWARE BROCHURE FOR MORE DETAILS





# Pier

*A modern shower enclosure featuring a minimalist frame, elongated brass chrome-plated handle and 8mm toughened glass.*



Single Slider  
56



Hinged Door  
57

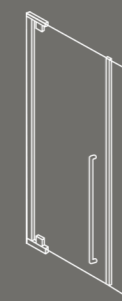

Hinged Door with  
Inline Panel  
58

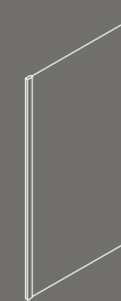

Walk-In  
59



# Pier - Single Slider

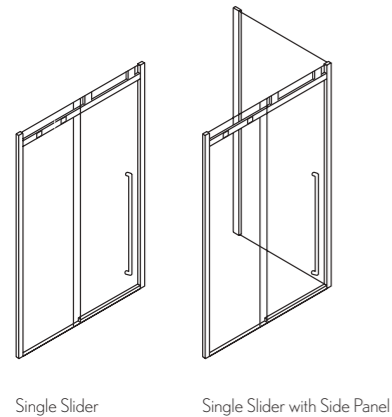

Single Slider      Single Slider with Side Panel

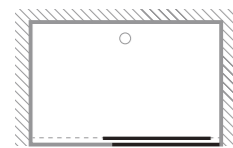

Door opening



Shown right: 1400mm Door. 1400 x 900 x 25mm Stone Resin Shower Tray. High Flow Shower Waste. Water Square Shower Valve. Glide Shower Head. Pier Furniture. Celeste Mirror. To see our full range visit [www.crosswater.co.uk](http://www.crosswater.co.uk)

# Pier - Hinged Door

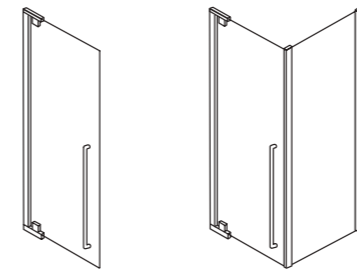



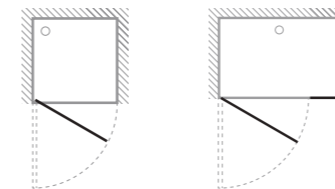











Hinged Door      Hinged Door with Side Panel



Door opening      Door opening (1 Inline Panel)



Shown right: 900mm Door. 900 x 900mm Shower Tray. High Flow Shower Waste. Pier Tap. Dial Shower Valve & Head. Svelte Towel Rail. Pier Furniture. Celeste Mirror. To see our full range visit [www.crosswater.co.uk](http://www.crosswater.co.uk)

-   
8mm toughened glass
-   
25mm adjustment for easy fitting
-   
2000mm enclosure height
-   
Power shower proof
-   
Reversible design
-   
Frameless sliding door
-   
Magnet closing
-   
Stainless Steel finish
-   
Wet room compatible
-   
Easy Clean - Crosswater Clear as standard
-   
Lifetime Guarantee
-   
Concealed profile fixings
-   
Quick release mechanism, for easy cleaning
-   
Squeeze gasket installation













Width	Door Entry Width	Adjustment	Product Code	PRICE (£)
<b>Single Slider</b>				
1200mm	489	1170 - 1195	PSLSC1200	£925.00
1400mm	589	1370 - 1395	PSLSC1400	£975.00
1600mm	689	1570 - 1595	PSLSC1600	£1,025.00
<b>Side Panels</b>				
800mm	N/A	765 - 790	PSLSP0800	£475.00
900mm	N/A	865 - 890	PSLSP0900	£495.00

<b>Options</b>				
Optional Closing Profile		PIERMAGNET		£65.00

For additional sundries, please see page 90.

Door entry widths change if using a side panel or the optional closing profile, contact [Crosswater](http://www.crosswater.co.uk) for more information.

For wet room solutions, see page 128.

-   
8mm toughened glass
-   
30mm adjustment for easy fitting
-   
2000mm enclosure height (side panels 1980mm)
-   
Power shower proof
-   
Reversible design
-   
Outward opening door
-   
Magnet closing
-   
Stainless Steel finish
-   
Wet room compatible
-   
Easy Clean - Crosswater Clear as standard
-   
Lifetime Guarantee
-   
Squeeze gasket installation

Width	Door Entry Width	Adjustment	Product Code	PRICE (£)
<b>Hinged Door</b>				
800mm	660	765 - 795 (770 - 795*)	PHDSC0800	£755.00
900mm	760	865 - 895 (870 - 895*)	PHDSC0900	£765.00

<b>Required</b>				
Installation Kit (Required when purchasing Inline and/or Side Panel)			PIERBRACE	£205.00

<b>Hinged Door with Inline Panel</b>				
1200mm	N/A	1160 - 1205 (1170 - 1195*)	PHDSC0800/PIPSC0400	£1,004.00
1300mm	N/A	1260 - 1305 (1270 - 1295*)	PHDSC0900/PIPSC0400	£1,014.00
1400mm	N/A	1360 - 1405 (1370 - 1395*)	PHDSC0800/PIPSC0600	£1,014.00
1500mm	N/A	1460 - 1505 (1470 - 1495*)	PHDSC0900/PIPSC0600	£1,024.00

<b>Side Panels</b>				
700mm	N/A	670 - 695 (665 - 690**)	PSPSC0700	£345.00
800mm	N/A	770 - 795 (765 - 790**)	PSPSC0800	£355.00
900mm	N/A	870 - 895 (865 - 890**)	PSPSC0900	£365.00
1000mm	N/A	970 - 995 (965 - 990**)	PSPSC1000	£375.00

For additional sundries, please see page 90.

\*Adjustment when used with a side panel. \*\*Adjustment when used with an inline panel.

For wet room solutions, see page 128.



# Pier - Walk-In Configurations

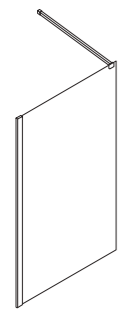

Recess

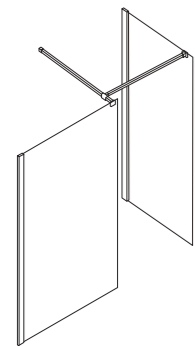

Corner with End Panel

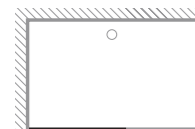

Opening (Recess)

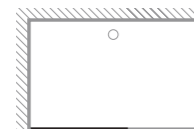

Opening (Corner with End Panel)

8mm toughened glass	25mm adjustment for easy fitting	1980mm enclosure height
Power shower proof	Reversible design	Stainless Steel finish
Wet room compatible	Easy Clean - Crosswater Clear as standard	Lifetime Guarantee
Concealed profile fixings	Squeeze gasket installation	



Recess



Corner with End Panel

Width	Panel size	Adjustment	Product Code	PRICE (£)
<b>Recess</b>				
1200 x 800 & 1200 x 900	700mm	645 - 670	PSPSC0700-WK	£484.00
1400 x 800 & 1400 x 900	900mm	845 - 870	PSPSC0900-WK	£504.00
1500 x 800 & 1500 x 900	1000mm	945 - 970	PSPSC1000-WK	£514.00

We recommend a minimum entry opening of 500mm

### Options

Bracing Bar (recommended for sizes 900 and above)	PI0000029	£65.00
---	-----------	--------

### Corner with End Panel

1200 x 800	700mm	645 - 670 (Front panel)	PSPSC0700-WK	£978.00
	800mm	745 - 770 (End panel)	PSPSC0800-WK	
1200 x 900	700mm	645 - 670 (Front panel)	PSPSC0700-WK	£988.00
	900mm	845 - 870 (End panel)	PSPSC0900-WK	
1400 x 800	900mm	845 - 870 (Front panel)	PSPSC0900-WK	£998.00
	800mm	745 - 770 (End panel)	PSPSC0800-WK	
1400 x 900	900mm	845 - 870 (Front panel)	PSPSC0900-WK	£1,008.00
	900mm	845 - 870 (End panel)	PSPSC0900-WK	
1500 x 800	1000mm	945 - 970 (Front panel)	PSPSC1000-WK	£1,008.00
	800mm	745 - 770 (End panel)	PSPSC0800-WK	
1500 x 900	1000mm	945 - 970 (Front panel)	PSPSC1000-WK	£1,018.00
	900mm	845 - 870 (End panel)	PSPSC0900-WK	

We recommend a minimum entry opening of 500mm

### Recommended

T-shaped Bracing Bar	PI0000030	£85.00
----------------------	-----------	--------

Bespoke options available, please see website.

For additional sundries, please see page 90.

For wet room solutions, see page 128.

# Pier - Walk-In Configurations

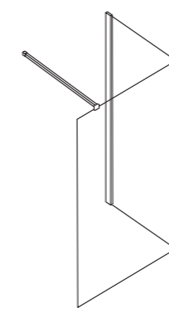

Corner Panel to Panel

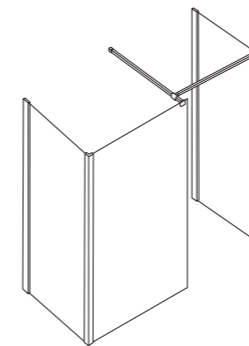

Three sided

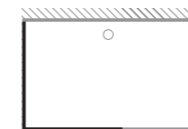

Opening (Corner Panel to Panel)

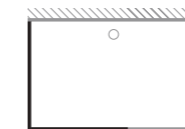

Opening (Three sided)

8mm toughened glass	25mm adjustment for easy fitting	1980mm enclosure height
Power shower proof	Reversible design	Stainless Steel finish
Wet room compatible	Easy Clean - Crosswater Clear as standard	Lifetime Guarantee
Concealed profile fixings	Squeeze gasket installation	



Corner Panel to Panel



Three sided

Width	Door Entry Width	Adjustment	Product Code	PRICE (£)
<b>Corner Panel to Panel</b>				
1200 x 800	700mm	N/A (Front panel)	PSPSC0700-WK	£839.00
	800mm	745-770 (Side panel)	PSPSC0800	
1200 x 900	700mm	N/A (Front panel)	PSPSC0700-WK	£849.00
	900mm	845 - 870 (Side panel)	PSPSC0900	
1400 x 800	900mm	N/A (Front panel)	PSPSC0900-WK	£859.00
	800mm	745-770 (Side panel)	PSPSC0800	
1400 x 900	900mm	N/A (Front panel)	PSPSC0900-WK	£869.00
	900mm	845-870 (Side panel)	PSPSC0900	
1500 x 800	1000mm	N/A (Front panel)	PSPSC1000-WK	£869.00
	800mm	745-770 (Side panel)	PSPSC0800	
1500 x 900	1000mm	N/A (Front panel)	PSPSC1000-WK	£879.00
	900mm	845-870 (Side panel)	PSPSC0900	

We recommend a minimum entry opening of 500mm

### Required

Bracing Bar	PI0000029	£65.00
Corner post	PI0000020	£45.00

### Three Sided

1200 x 800	700mm	N/A (Front panel)	PSPSC0700-WK	£1,333.00
	800mm	745-770 (Side panel)	PSPSC0800-WK	
	800mm	745-770 (End panel)	PSPSC0800	
1200 x 900	700mm	N/A (Front panel)	PSPSC0700-WK	£1,353.00
	900mm	845 - 870 (Side panel)	PSPSC0900-WK	
	900mm	845 - 870 (End panel)	PSPSC0900	
1400 x 800	900mm	N/A (Front panel)	PSPSC0900-WK	£1,353.00
	800mm	745-770 (Side panel)	PSPSC0800-WK	
	800mm	745-770 (Side panel)	PSPSC0800	
1400 x 900	900mm	N/A (Front panel)	PSPSC0900-WK	£1,373.00
	900mm	845-870 (Side panel)	PSPSC0900-WK	
	900mm	845-870 (End panel)	PSPSC0900	
1500 x 800	1000mm	N/A (Front panel)	PSPSC1000-WK	£1,363.00
	800mm	745-770 (Side panel)	PSPSC0800-WK	
	800mm	745-770 (End panel)	PSPSC0800	
1500 x 900	1000mm	N/A (Front panel)	PSPSC1000-WK	£1,383.00
	900mm	845-870 (Side panel)	PSPSC0900-WK	
	900mm	845-870 (End panel)	PSPSC0900	

We recommend a minimum entry opening of 500mm

### Required

T-shaped Bracing Bar	PI0000030	£85.00
Corner post	PI0000020	£45.00





# Ten

*Choose luxurious 10mm frameless glass for the latest in modern, minimalist styling.*

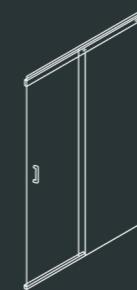

Single Slider  
62



Hinged Door with  
Inline Panel  
63

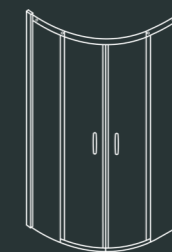

Quadrant Double Door  
64



# Ten - Single Slider

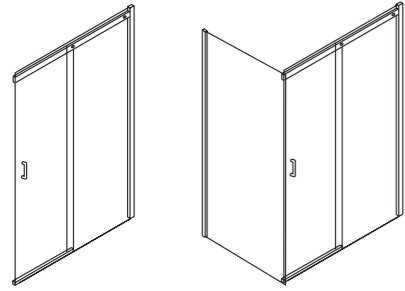

Single Slider

Single Slider with Side Panel

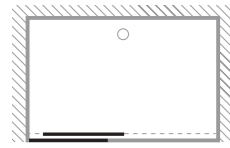

Door opening

Shown right: 1600mm Door. 800 x 1600mm Rectangular Stone Resin Shower Tray & Waste. Water Square Shower Valve. Revive Shower Head. To see our full range visit [www.crosswater.co.uk](http://www.crosswater.co.uk)



# Ten - Hinged Door with Inline Panel

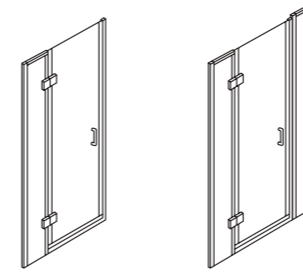

Hinged Door with Inline panel

Hinged Door with 2 Inline Panels (1200 & 1400mm)

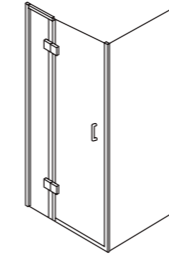

Hinged Door with Inline Panel & Side Panel

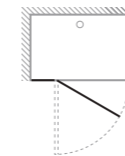

Door opening (1 Inline Panel)

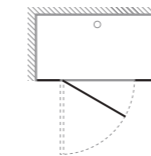

Door opening (2 Inline Panels)

Shown right: 900mm (L/H) Door. 900mm Side Panel. 900 x 900mm Shower Tray. High Flow Shower Waste. Water Square Shower Valve. Glide Shower Head. Rex Ceiling Shower Arm. To see our full range visit [www.crosswater.co.uk](http://www.crosswater.co.uk)



- 10mm toughened glass
- 30mm adjustment for easy fitting
- 1950mm enclosure height
- Power shower proof
- Reversible design
- Frameless sliding door
- Silver finish frame
- Wet room compatible
- Easy Clean - Crosswater Clear as standard
- Lifetime Guarantee

Width	Door Entry Width	Adjustment	Product Code	PRICE (£)
<b>Single Slider</b>				
1200mm	475	1160 - 1190	TSLSC1200	£1,095.00
1400mm	557	1360 - 1390	TSLSC1400	£1,165.00
1600mm	637	1560 - 1590	TSLSC1600	£1,185.00
1700mm	637	1660 - 1690	TSLSC1700	£1,225.00
<b>Side Panels</b>				
800mm	N/A	775 - 790	10800PANEL	£515.00
900mm	N/A	875 - 890	10900PANEL	£590.00

For additional sundries, please see page 90.

**This enclosure requires a shower tray with a minimum ledge of 60mm.**

For wet room solutions, see page 128.

- 10mm toughened glass
- 30mm adjustment for easy fitting
- 1950mm enclosure height
- Power shower proof
- Reversible design
- Outward opening door
- Magnet closing
- Silver finish frame
- Wet room compatible
- Easy Clean - Crosswater Clear as standard
- Lifetime Guarantee

Width	Door Entry Width	Adjustment	Product Code	PRICE (£)
<b>Hinged Door with Inline Panel</b>				
800mm	500	770 - 800 (750 - 765*)	THDSC0800	£930.00
900mm	600	870 - 900 (850 - 865*)	THDSC0900	£980.00
1000mm	600	970 - 1000 (950 - 965*)	THDSC1000	£1,065.00
<b>Side Panels</b>				
800mm	N/A	775 - 790	TSPSC0800	£525.00
900mm	N/A	875 - 890	TSPSC0900	£585.00

### Options

Spare Handle	10HANDLE	£140.00
--------------	----------	---------

For additional sundries, please see page 90.

**\*Adjustment when used with a side panel.**

For wet room solutions, see page 128.





# Ten - Quadrant double door

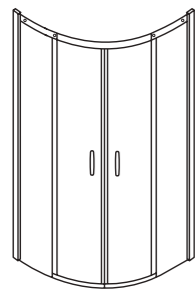

Quadrant Double Door

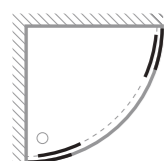

Door opening

Shown right: 900mm Enclosure. 900 x 900mm Shower Tray. High Flow Shower Waste. Central Shower Valve. Central Shower Head. Rex Ceiling Shower Arm. To see our full range visit [www.crosswater.co.uk](http://www.crosswater.co.uk)



-  8mm (door) 10mm (fixed panels) toughened glass
-  15mm adjustment for easy fitting
-  1950mm enclosure height
-  Power shower proof
-  Sliding doors
-  Magnet closing
-  Silver finish frame
-  Wet room compatible
-  Easy Clean - Crosswater Clear as standard
-  Lifetime Guarantee

Width	Door Entry Width	Adjustment	Product Code	PRICE (£)
<b>Quadrant Double Door</b>				
900mm	540	875 - 890 (15mm per panel)	TQDSC0900	£1,175.00
1000mm	540	975 - 990 (15mm per panel)	TQDSC1000	£1,216.00

For additional sundries, please see page 90.

**This enclosure requires a shower tray with a minimum ledge of 60mm.**

For wet room solutions, see page 128.

**beautiful  
brassware**

*Looking for a complete brassware solution to suit your enclosure? We have everything you need to create an indulgent showering experience.*



*hip to be square!*

Water Square shower valves are the perfect pairing for the angles of our square and pentagon enclosures.

SEE THE PREMIUM BRASSWARE BROCHURE FOR MORE DETAILS.



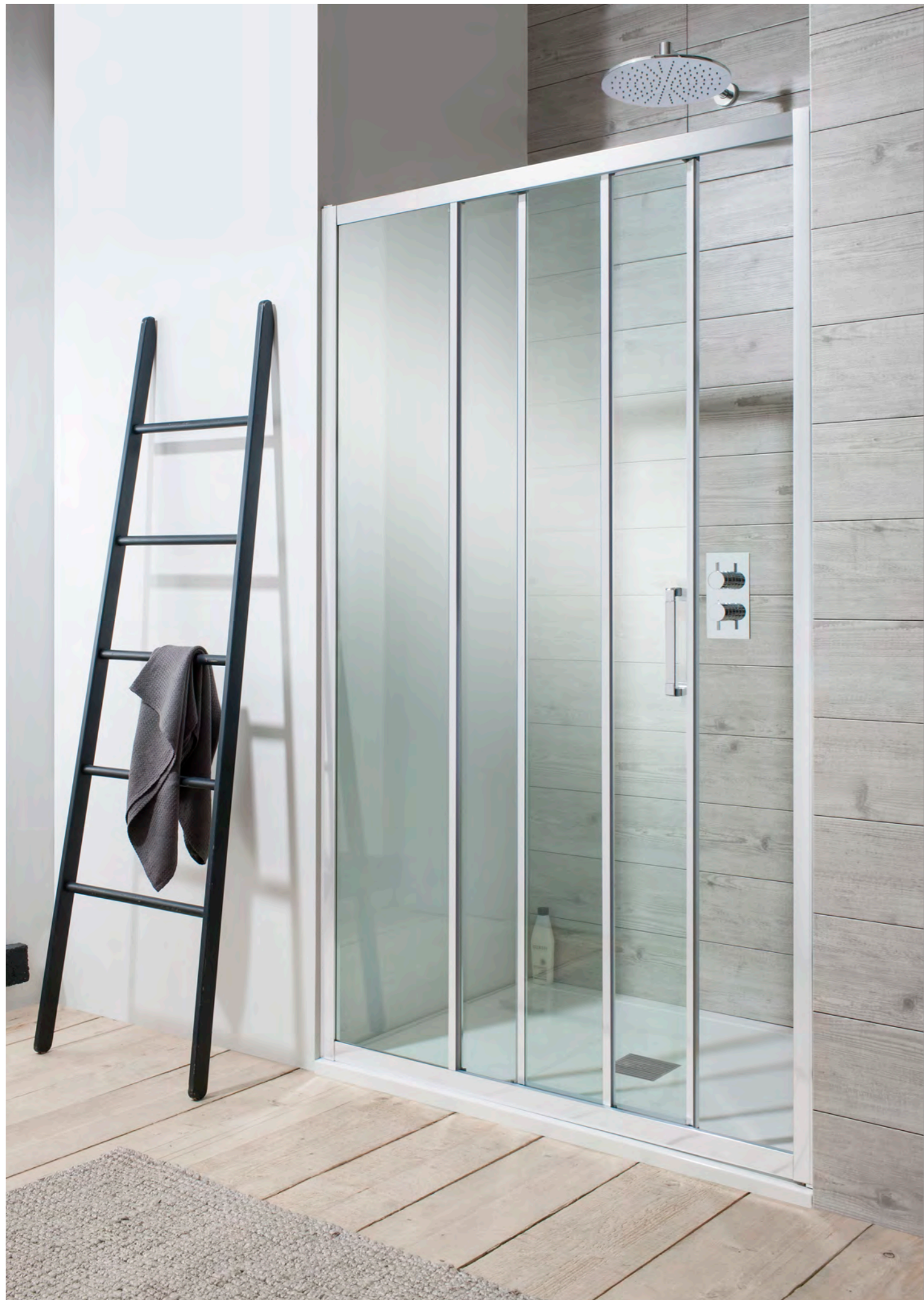

# Edge

*A sleek silver frame, complemented by smooth lines and a minimal door frame.*

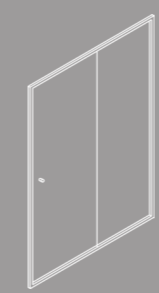

Single Slider  
68



Triple Slider  
69

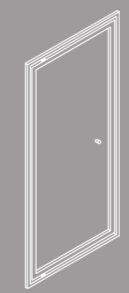

Pivot Door  
70

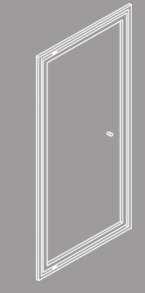

Infold Door  
71

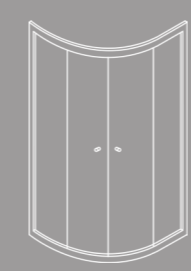

Quadrant Double Door  
72

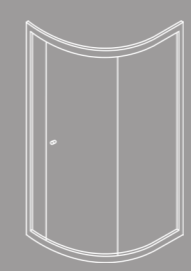

Quadrant Single Door  
73

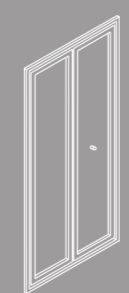

Bi-Fold Door  
74

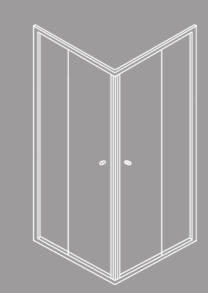

Corner Entry  
75



# Edge - Single Slider

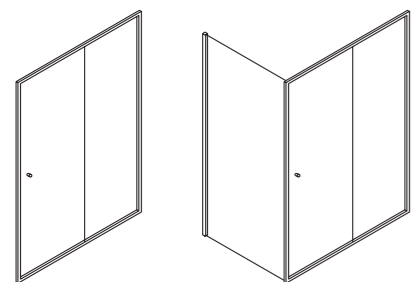

Single Slider      Single Slider with Side Panel

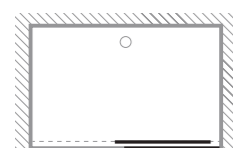

Door opening



Shown right: 1200mm Door. 800mm Side Panel. 800 x 1200mm Shower Tray. Dial Shower Valve & Head. Svelte WC. To see our full range visit [www.crosswater.co.uk](http://www.crosswater.co.uk)

# Edge - Triple Slider



Triple Slider

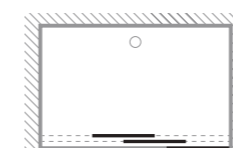

Door opening



Shown right: 1200mm Enclosure. 1200 x 900mm Shower Tray. Kai Lever Shower Valve. Contour Shower Head. Straight Shower Arm. To see our full range visit [www.crosswater.co.uk](http://www.crosswater.co.uk)

Width	Door Entry Width	Adjustment	Product Code	PRICE (£)
<b>Single Slider</b>				
1000mm	393	960 - 990	ESLSC1000	£535.00
1100mm	443	1060 - 1090	ESLSC1100	£545.00
1200mm	493	1160 - 1190	ESLSC1200	£565.00
1400mm	593	1360 - 1390	ESLSC1400	£610.00
1500mm	643	1460 - 1490	ESLSC1500	£620.00
1600mm	643	1560 - 1590	ESLSC1600	£650.00
<b>Side Panel</b>				
700mm	N/A	675 - 690	ESPSC0700	£245.00
760mm	N/A	735 - 750	ESPSC0760	£250.00
800mm	N/A	775 - 790	ESPSC0800	£260.00
900mm	N/A	875 - 890	ESPSC0900	£280.00
1000mm	N/A	975 - 990	ESPSC1000	£290.00

For additional sundries, please see page 90.  
For wet room solutions, see page 128.

Width	Door Entry Width	Adjustment	Product Code	PRICE (£)
<b>Triple Slider</b>				
900mm	428	870 - 910	ETSSC0900	£505.00
1000mm	495	970 - 1010	ETSSC1000	£505.00
1200mm	628	1170 - 1210	ETSSC1200	£515.00

For additional sundries, please see page 90.  
For wet room solutions, see page 128.

**wider access**

*The ultimate shower door for maximising entry width, individual glass panels slide together when opened to create a wider space for entering and exiting the enclosure.*



# Edge - Pivot Door

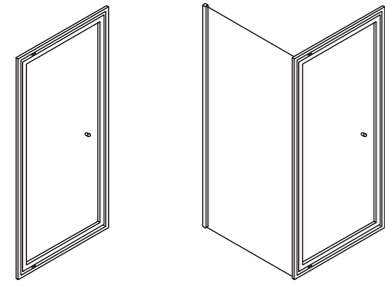

Pivot Door

Pivot Door with Side Panel

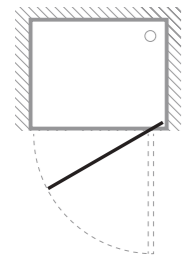

Door opening



Shown right: 900mm Door. 900 x 900mm Shower Tray. Kai Lever Shower Valve. Contour Shower Head. Straight Shower Arm. To see our full range visit [www.crosswater.co.uk](http://www.crosswater.co.uk)

-   
6mm toughened glass
-   
30mm adjustment for easy fitting
-   
1950mm enclosure height
-   
Power shower proof
-   
Reversible design
-   
Outward opening door
-   
Magnet closing
-   
Silver finish frame
-   
Wet room compatible
-   
Easy Clean - Crosswater Clear as standard
-   
Lifetime Guarantee

Width	Door Entry Width	Adjustment	Product Code	PRICE (£)
<b>Pivot Door</b>				
700mm	477	660 - 690	EPDSC0700	£375.00
760mm	506	720 - 750	EPDSC0760	£395.00
800mm	546	760 - 790	EPDSC0800	£415.00
900mm	646	860 - 890	EPDSC0900	£425.00
1000mm	646	960 - 990	EPDSC1000	£445.00
<b>Side Panel</b>				
700mm	N/A	675 - 690	ESPSC0700	£245.00
760mm	N/A	735 - 750	ESPSC0760	£250.00
800mm	N/A	775 - 790	ESPSC0800	£260.00
900mm	N/A	875 - 890	ESPSC0900	£280.00
1000mm	N/A	975 - 990	ESPSC1000	£290.00

For additional sundries, please see page 90.  
For wet room solutions, see page 128.

# Edge - Infold Door

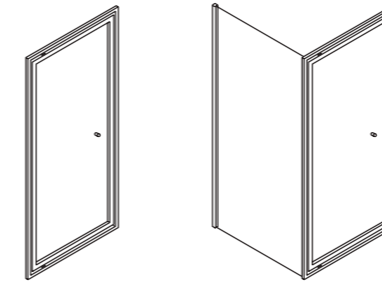

Infold Door



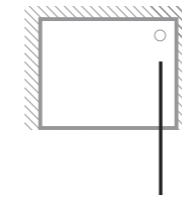







Infold Door with Side Panel



Door opening



Shown right: 900mm Door. 760 x 900mm Shower Tray. Wisp Tap. Kai Lever Shower Valve. Magnum Shower Kit. Celeste Illuminated Mirror. Elite Steel Furniture. To see our full range visit [www.crosswater.co.uk](http://www.crosswater.co.uk)

-   
6mm toughened glass
-   
30mm adjustment for easy fitting
-   
1950mm enclosure height
-   
Power shower proof
-   
Reversible design
-   
Infold door
-   
Magnet closing
-   
Silver finish frame
-   
Wet room compatible
-   
Easy Clean - Crosswater Clear as standard
-   
Lifetime Guarantee



Width	Door Entry Width	Adjustment	Product Code	PRICE (£)
<b>Infold Door</b>				
700mm	495	660 - 690	EIDSC0700	£490.00
760mm	555	720 - 750	EIDSC0760	£525.00
800mm	595	760 - 790	EIDSC0800	£545.00
900mm	695	860 - 890	EIDSC0900	£565.00
1000mm	791	960 - 990	EIDSC1000	£590.00
<b>Side Panel</b>				
700mm	N/A	675 - 690	ESPSC0700	£245.00
760mm	N/A	735 - 750	ESPSC0760	£250.00
800mm	N/A	775 - 790	ESPSC0800	£260.00
900mm	N/A	875 - 890	ESPSC0900	£280.00
1000mm	N/A	975 - 990	ESPSC1000	£290.00

For additional sundries, please see page 90. For wet room solutions, see page 128.



*The perfect solution for smaller spaces, our Edge infold shower door reduces the footprint of the opening panel by mounting it on a sliding rail.*



# Edge - Quadrant Double Door

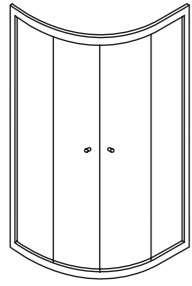

Quadrant Double Door

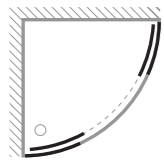

Door opening



Shown right: 900mm Enclosure. 900 x 900mm Shower Tray. Kai Lever Shower Valve. Contour Shower Head. Straight Shower Arm. To see our full range visit [www.crosswater.co.uk](http://www.crosswater.co.uk)

# Edge - Quadrant Single Door

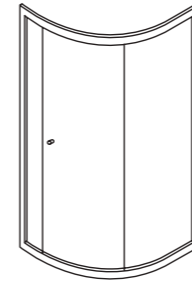

Quadrant Single Door

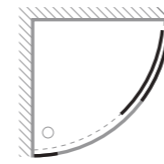

Door opening



Shown right: 1200 x 800mm Enclosure. 1200 x 800mm Shower Tray. Kai Lever Shower Valve. Contour Shower Head. Straight Shower Arm. To see our full range visit [www.crosswater.co.uk](http://www.crosswater.co.uk)



- 6mm toughened glass
- 15mm adjustment for easy fitting per panel
- 1950mm enclosure height
- Power shower proof
- Reversible design
- Sliding door
- Magnet closing
- Silver finish frame
- Wet room compatible
- Easy Clean - Crosswater Clear as standard
- Lifetime Guarantee
- Quick release rollers

Width	Door Entry Width	Adjustment	Product Code	PRICE (£)
<b>Quadrant Double Door</b>				
800mm	450	770 - 785	EQDSC0800	£585.00
900mm	540	870 - 885	EQDSC0900	£620.00

For additional sundries, please see page 90.  
For wet room solutions, see page 128.



*Complement the curves of your Edge enclosure with a quadrant or offset quadrant shower tray, designed for the perfect fit.*

*See page 114 for more information.*

- 6mm toughened glass
- 15mm adjustment for easy fitting per panel
- 1950mm enclosure height
- Power shower proof
- Reversible design
- Sliding door
- Silver finish frame
- Wet room compatible
- Easy Clean - Crosswater Clear as standard
- Lifetime Guarantee
- Quick release rollers

Width	Door Entry Width	Adjustment	Product Code	PRICE (£)
<b>Quadrant Single Door</b>				
800mm	480	770 - 785	EOSSC0800	£625.00
900mm	480	870 - 885	EOSSC0900	£690.00
1000mm	480	970 - 985	EOSSC1000	£765.00
1000 x 800mm	480	970 - 985 x 770 - 785	EOSSC10X8	£725.00
1200 x 800mm	480	1170 - 1185 x 770 - 785	EOSSC12X8	£775.00
1200 x 900mm	480	1170 - 1185 x 870 - 885	EOSSC12X9	£785.00

For additional sundries, please see page 90.  
For wet room solutions, see page 128.



# Edge - Bi-Fold Door

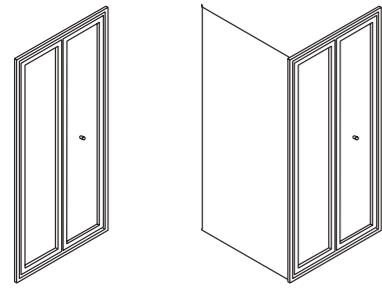

Bi-fold Door



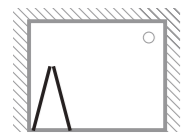







Bi-fold Door with Side Panel



Door opening



Shown right: 900mm Door. 900 x 900mm 25mm Stone Resin Shower Tray. Kai Lever Shower Valve. Contour Shower Head. Straight Shower Arm. To see our full range visit [www.crosswater.co.uk](http://www.crosswater.co.uk)

-   
6mm toughened glass
-   
30mm adjustment for easy fitting
-   
1950mm enclosure height
-   
Power shower proof
-   
Reversible design
-   
Folding doors
-   
Magnet closing
-   
Silver finish frame
-   
Wet room compatible
-   
Easy Clean - Crosswater Clear as standard
-   
Lifetime Guarantee

Width	Door Entry Width	Adjustment	Product Code	PRICE (£)
<b>Bi-Fold Door</b>				
700mm	455	660 - 690	EBFSC0700	£415.00
760mm	455	720 - 750	EBFSC0760	£460.00
800mm	495	760 - 790	EBFSC0800	£490.00
900mm	595	860 - 890	EBFSC0900	£510.00
1000mm	665	960 - 990	EBFSC1000	£565.00
<b>Side Panel</b>				
700mm	N/A	675 - 690	ESPSC0700	£245.00
760mm	N/A	735 - 750	ESPSC0760	£250.00
800mm	N/A	775 - 790	ESPSC0800	£260.00
900mm	N/A	875 - 890	ESPSC0900	£280.00
1000mm	N/A	975 - 990	ESPSC1000	£290.00

For additional sundries, please see page 90.  
For wet room solutions, see page 128.

# Edge - Corner Entry

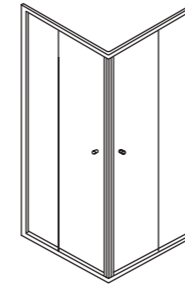



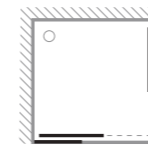









Corner Entry



Door opening



Shown right: 900mm Door. 900 x 900mm 25mm Stone Resin Shower Tray. Kai Lever Shower Valve. Contour Shower Head. Straight Shower Arm. To see our full range visit [www.crosswater.co.uk](http://www.crosswater.co.uk)

-   
6mm toughened glass
-   
15mm adjustment for easy fitting per panel
-   
1950mm enclosure height
-   
Power shower proof
-   
Reversible design
-   
Sliding doors
-   
Magnet closing
-   
Silver finish frame
-   
Wet room compatible
-   
Easy Clean - Crosswater Clear as standard
-   
Lifetime Guarantee
-   
Quick release rollers



Width	Door Entry Width	Adjustment	Product Code	PRICE (£)
<b>Corner Entry</b>				
760mm	367	730 - 745	ECESC0760	£705.00
800mm	395	770 - 785	ECESC0800	£725.00
900mm	470	870 - 885	ECESC0900	£775.00

For additional sundries, please see page 90.  
For wet room solutions, see page 128.





# Click

*Easy to install with minimal fuss and tools, designed with 6mm glass and a reversible door for added convenience.*



Hinged Door  
78

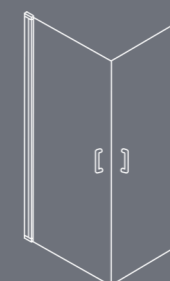

Easy Access  
Double Hinged Door  
79



# Click - Hinged Door

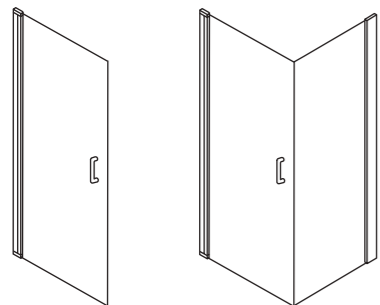

Hinged Door

Hinged Door with Side Panel

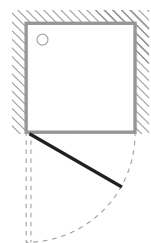

Door opening



Shown right: 900mm Door. 900 x 900mm Shower Tray. Wisp Shower Kit. Designer Wall Outlet. Kai Lever Shower Valve. To see our full range visit [www.crosswater.co.uk](http://www.crosswater.co.uk)

- 6mm toughened glass
- 30mm adjustment for easy fitting
- 1950mm enclosure height (side panels 1930mm)

- Power shower proof
- Reversible design
- Outward opening door

- Magnet closing
- Silver finish frame
- Wet room compatible

- Easy Clean - Crosswater Clear as standard
- Lifetime Guarantee
- "Click" profile system

- Fast install profiles with concealed fixings
- Squeeze gasket installation

Width	Door Entry Width	Adjustment	Product Code	PRICE (£)
<b>Hinged Door</b>				
800mm	672	770 - 800 (770 - 790*)	NHDSC0800	£355.00
900mm	772	870 - 900 (870 - 890*)	NHDSC0900	£365.00
<b>Recess application requires NHDR Recess Channel</b>			NHDR	£85.00
<b>Side Panel</b>				
800mm	762 - 782	1931	NSPSC0800	£255.00
900mm	862 - 882	1931	NSPSC0900	£265.00

\*Adjustment when used with a side panel.  
For wet room solutions, see page 128.  
To view an installation video for this product please visit [youtube.com/CrosswaterHoldings](https://youtube.com/CrosswaterHoldings)

**function & form**

*From multiple spray patterns and premium styles, we have a range of high-performance shower kits to suit your enclosure space.*

*See the Premium Brassware brochure for more information.*

# Click - Easy Access Double Hinged Door

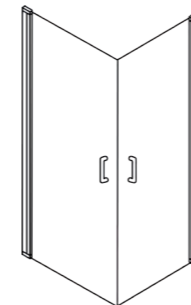

Corner Entry

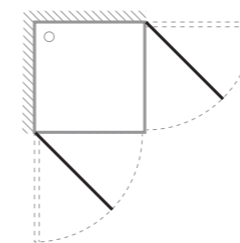

Door opening



Shown right: 800mm Double Hinged Door. 800 x 800mm Shower Tray. Wisp Shower Kit. Designer Wall Outlet. Kai Lever Shower Valve. To see our full range visit [www.crosswater.co.uk](http://www.crosswater.co.uk)

- 6mm toughened glass
- 20mm adjustment on each side
- 1950mm enclosure height

- Power shower proof
- Reversible design
- Outward opening doors

- Magnet closing
- Silver finish frame
- Wet room compatible

- Easy Clean - Crosswater Clear as standard
- Lifetime Guarantee
- "Click" profile system

- Fast install profiles with concealed fixings

Width	Door Entry Width	Adjustment	Product Code	PRICE (£)
<b>Easy Access Double Hinged Door</b>				
800 x 800mm	672	770-790 & 870-890	NCESC0800	£750.00
900 x 900mm	772	870 - 900	NCESC0900	£760.00

For wet room solutions, see page 128.







# Supreme

*A range of quality, easy-to-install shower enclosures with a modern silver frame.*



Single Slider  
82



Luxury Pivot Door  
83



Pivot Door with  
Inline Panel  
84



Pivot Door  
85

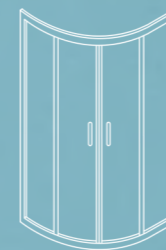

Luxury Curved Quadrant  
86



Quadrant Single Door  
87



Bi-Fold Door  
88



# Supreme - Single Slider

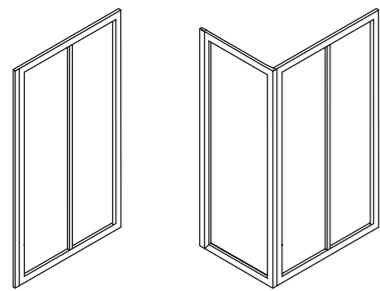

Single Slider

Single Slider with Side Panel

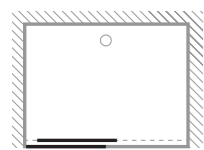

Door opening



Shown right: 1200mm Door. 800 x 1200mm Shower Tray. Dial Shower Kit. To see our full range visit [www.crosswater.co.uk](http://www.crosswater.co.uk)

# Supreme - Luxury Pivot Door

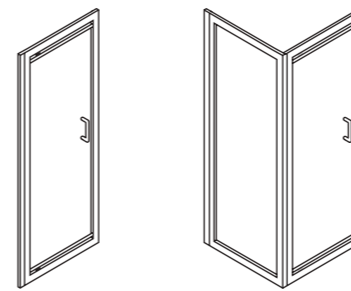

Luxury Pivot Door

Luxury Pivot Door with Side Panel

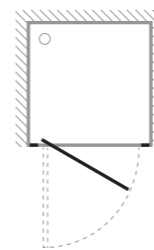

Door opening



Shown right: 760/800mm Door. 800 x 800mm Shower Tray. Dial Shower Kit. To see our full range visit [www.crosswater.co.uk](http://www.crosswater.co.uk)

-  4mm toughened glass
-  60mm adjustment for easy fitting
-  1850mm enclosure height
-  Power shower proof
-  Reversible design
-  Sliding door
-  Magnet closing
-  Silver finish frame
-  Wet room compatible
-  Easy Clean - Crosswater Clear as standard
-  Lifetime Guarantee
-  Easy installation

Width	Door Entry Width	Adjustment	Product Code	PRICE (£)
<b>Single Slider</b>				
1000mm	385	940 - 1000	7337	£455.00
1100mm	435	1040 - 1100	7336	£455.00
1200mm	485	1140 - 1200	7061	£465.00
1400mm	585	1340 - 1400	7345	£555.00
<b>Side Panel</b>				
800mm	N/A	765 - 795	7166	£235.00
900mm	N/A	865 - 895	7150	£270.00













### Options

Bracing bars - for a 3-sided enclosure two Supreme bracing bars are required - see page 90.  
Frame extension profiles - for frame extension profiles 32mm, please refer to page 127.

For additional sundries, please see page 90.

For wet room solutions, see page 128.

**Please note a side panel will add 8mm to the minimum width of a door.**

-  6mm toughened glass
-  60mm adjustment for easy fitting
-  1850mm enclosure height
-  Power shower proof
-  Reversible design
-  Outward opening door
-  Ball catch closing
-  Silver finish frame
-  Wet room compatible
-  Easy Clean - Crosswater Clear as standard
-  Lifetime Guarantee
-  Easy installation

Width	Door Entry Width	Adjustment	Product Code	PRICE (£)
<b>Luxury Pivot Door</b>				
760/800mm	564	735 - 795	7311	£540.00
900mm	669	840 - 900	7312	£580.00
<b>Side Panel</b>				
800mm	N/A	765 - 795	7166	£235.00
900mm	N/A	865 - 895	7150	£270.00

### Options

Bracing bars - for a 3-sided enclosure two Supreme bracing bars are required - see page 90.  
Frame extension profiles - for frame extension profiles 32mm, please refer to page 127.

For additional sundries, please see page 90.

For wet room solutions, see page 128.

**Please note a side panel will add 8mm to the minimum width of a door.**



# Supreme - Pivot Door with Inline Panel

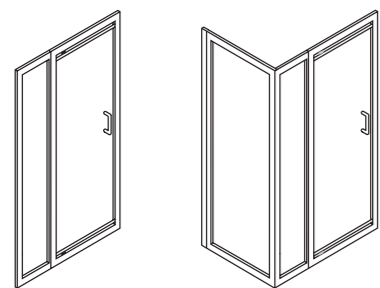

Pivot Door with Inline Panel

Pivot Door with Inline Panel & Side Panel

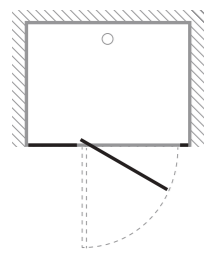

Door opening



Shown right: 1200mm Door. 800 x 1200mm Shower Tray. Dial Shower Kit. To see our full range visit [www.crosswater.co.uk](http://www.crosswater.co.uk)

# Supreme - Pivot Door

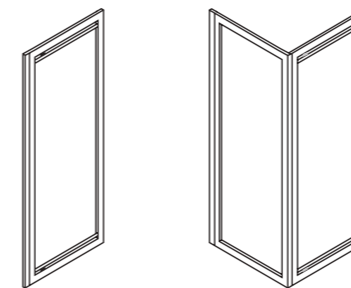

Pivot Door



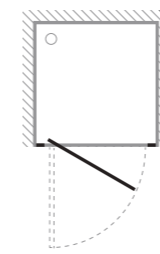









Pivot Door with Side Panel



Door opening



Shown right: 800mm+ Door. 800 x 800mm Shower Tray. Dial Shower Kit. To see our full range visit [www.crosswater.co.uk](http://www.crosswater.co.uk)

-   
4mm toughened glass
-   
60mm adjustment for easy fitting
-   
1850mm enclosure height
-   
Power shower proof
-   
Reversible design
-   
Outward opening door
-   
Magnet closing
-   
Silver finish frame
-   
Wet room compatible
-   
Easy Clean - Crosswater Clear as standard
-   
Lifetime Guarantee
-   
Easy installation

Width	Door Entry Width	Adjustment	Product Code	PRICE (£)
<b>Pivot Door with Inline Panel</b>				
1100mm	554	1055 - 1115	7138/7153	£64000
1200mm	660	1160 - 1220	7141/7153	£68000
<b>Side Panel</b>				
800mm	N/A	765 - 795	7166	£235.00
900mm	N/A	865 - 895	7150	£270.00













### Options

Inline panels - inline panels are also suitable for use with Luxury Pivot Doors, see page 83.  
Bracing bars - for a 3-sided enclosure two Supreme bracing bars are required - see page 90.  
Frame extension profiles - for frame extension profiles 32mm, please refer to page 127.

For additional sundries, please see page 90.

For wet room solutions, see page 128.

**Please note a side panel will add 8mm to the minimum width of a door.**

-   
4mm toughened glass
-   
60mm adjustment for easy fitting
-   
1850mm enclosure height
-   
Power shower proof
-   
Reversible design
-   
Outward opening door
-   
Magnet closing
-   
Silver finish frame
-   
Wet room compatible
-   
Easy Clean - Crosswater Clear as standard
-   
Lifetime Guarantee
-   
Easy installation

Width	Door Entry Width	Adjustment	Product Code	PRICE (£)
<b>Pivot Door</b>				
600mm	389	570 - 630	7129	£310.00
700mm	489	670 - 730	7135	£310.00
760/800mm	554	735 - 795	7138	£310.00
900mm	660	840 - 900	7141	£350.00
<b>Side Panel</b>				
800mm	N/A	765 - 795	7166	£235.00
900mm	N/A	865 - 895	7150	£270.00

### Options

Bracing bars - for a 3-sided enclosure two Supreme bracing bars are required - see page 90.  
Frame extension profiles - for frame extension profiles 32mm, please refer to page 127.

For additional sundries, please see page 90.

For wet room solutions, see page 128.

**Please note a side panel will add 8mm to the minimum width of a door.**



# Supreme - Luxury Curved Quadrant

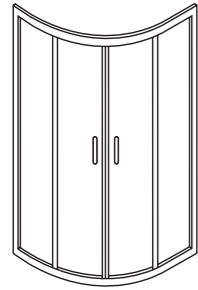

Luxury Curved Quadrant

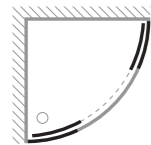

Door opening



Shown right: 800 x 800mm Enclosure. 800 x 800mm Shower Tray. Dial Shower Kit. To see our full range visit [www.crosswater.co.uk](http://www.crosswater.co.uk)

# Supreme - Quadrant Single Door

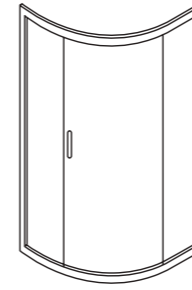

Quadrant Single Door

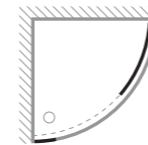

Door opening



Shown right: 900 x 900mm Enclosure. 900 x 900mm Shower Tray. Dial Shower Kit. To see our full range visit [www.crosswater.co.uk](http://www.crosswater.co.uk)

6mm toughened glass	25mm adjustment per side	1850mm enclosure height
Power shower proof	Reversible design	Sliding doors
Magnet closing	Silver finish frame	Wet room compatible
Easy Clean - Crosswater Clear as standard	Lifetime Guarantee	Easy installation
Quick release roller mechanisms for easy cleaning	To suit a Crosswater 550mm radius shower tray	

Width	Door Entry Width	Adjustment	Product Code	PRICE (£)
<b>Luxury Curved Quadrant</b>				
800 x 800mm	406	Door 420 Panels 765 - 790	5306	£535.00
900 x 900mm	510	Door 510 Panels 865 - 890	5305	£620.00

For additional sundries, please see page 90.  
For wet room solutions, see page 128.

6mm toughened glass	25mm adjustment per side	1850mm enclosure height
Power shower proof	Reversible design	Frameless sliding door
Silver finish frame	Wet room compatible	Easy Clean - Crosswater Clear as standard
Lifetime Guarantee	Easy installation	Quick release roller mechanisms for easy cleaning
To suit a Crosswater 550mm radius shower tray		

Width	Door Entry Width	Adjustment	Product Code	PRICE (£)
<b>Quadrant Single Door</b>				
900 x 900mm	460	Door 460 Panels 865 - 890	5331	£590.00
900 x 760mm	460	Door 460 Panel (760) 735 - 750 Panel (900) 865 - 890 (door slides back onto 900 panel)	5332	£590.00
1000 x 800mm	460	door 460 Panel (1000) 965 - 990 Panel (800) 765 - 790 (door slides back onto 1000 panel)	5336	£650.00
1200 x 800mm	453	Door 460 Panel (1200) 1165 - 1190 Panel (900) 765 - 790 (door slides back onto 1200 panel)	5337	£705.00
1200 x 900mm	460	Door 460 Panel (1200) 1165 - 1190 Panel (900) 865 - 890 (door slides back onto 900 panel)	5335	£705.00

For additional sundries, please see page 90.  
For wet room solutions, see page 128.



# Supreme - Bi-Fold Door



Bi-Fold Door

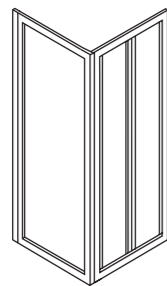

Bi-Fold Door with Side Panel

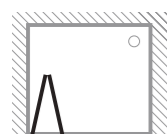

Door opening



Shown right: 800mm+ Door. 800 x 800mm Shower Tray. Dial Shower Kit. To see our full range visit [www.crosswater.co.uk](http://www.crosswater.co.uk)



4mm toughened glass



60mm adjustment per side



1850mm enclosure height



Power shower proof



Reversible design



Inward opening door



Magnet closing



Silver finish frame



Wet room compatible



Easy Clean - Crosswater Clear as standard



Lifetime Guarantee



Easy installation

Width	Door Entry Width	Adjustment	Product Code	PRICE (£)
<b>Bi-Fold Door</b>				
600mm+	379	598 - 658	7230	£415.00
700mm	450	668 - 728	7231	£415.00
760/800mm	515	734 - 794	7232	£415.00
800mm+	571	790 - 850	7289	£455.00
900mm	627	848 - 908	7233	£475.00
<b>Side Panel</b>				
800mm	N/A	765 - 795	7166	£235.00
900mm	N/A	865 - 895	7150	£270.00

### Options

Bracing bars - for a 3-sided enclosure two Supreme bracing bars are required - see page 90.

Frame extension profiles - for frame extension profiles 32mm, please refer to page 127.

For additional sundries, please see page 90.

For wet room solutions, see page 128.

**Please note a side panel will add 8mm to the minimum width of a door.**

# size matters!

Whether you favour a drenching soak or a more powerful flow, there is a fixed shower head size to suit you.

For more details see the Premium Brassware brochure or visit [www.crosswater.co.uk](http://www.crosswater.co.uk)

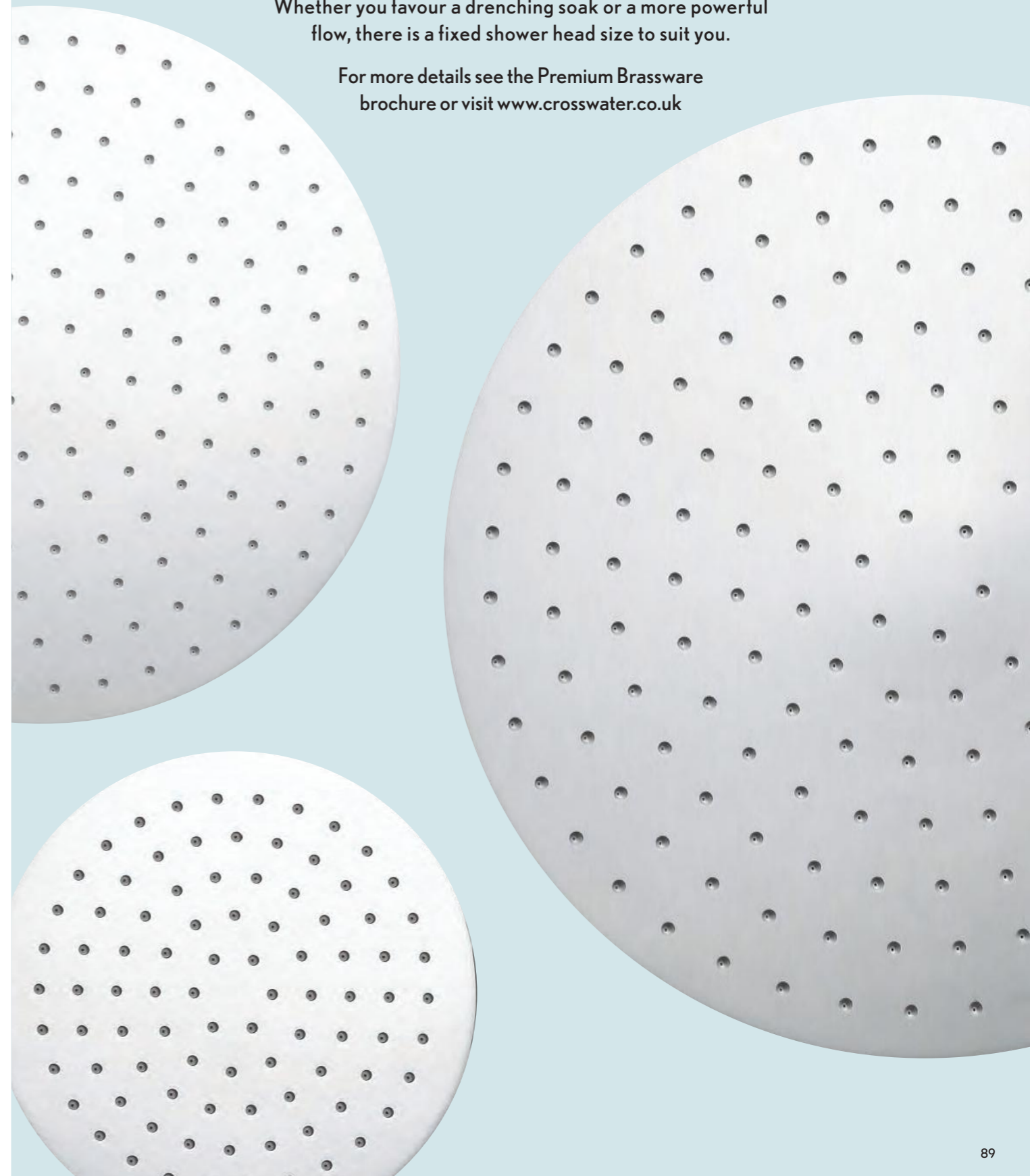

# Sundries

*Right down to the finest details, choose from a range of additional extras available across all of our shower enclosure ranges, such as bracing bars, seals and extension profiles.*

Bath Screen Sundries	Finish	Product code	Price (£)
Supreme Screen Rubber Seal (Vertical)	N/A	6025	£42.00
Supreme Bottom Rubber Seal	N/A	6026	£30.00
Classic Screen Seal	N/A	DVS000064	£31.00

Classic Sundries	Finish	Product code	Price (£)
D Shaped Door Handle	Silver	0112	£65.00
90° Door Handle	Silver	0190	£60.00
17mm Extension Profile	Silver	0115	£70.00
45mm Extension Profile	Silver	0118	£90.00
Wall Channel	Silver	0138	£85.00
Bracing Bar	Silver	7258	£42.00

Design+ Chrome Sundries	Finish	Product code	Price (£)
Outward Opening Hinges (Pair)	Silver	DS0000021+	£150.00
15mm Extension Profile	Silver	DS0000110+	£70.00
Wall Channel	N/A	DSLADJPROFILE	£55.00

Design+ Matt Black	Finish	Product code	Price (£)
Waste Grid	Matt black	LNGRID_MB	£45.00
Wall Channel	Matt black	DSLADJPROFILEMB	£70.00

Edge Sundries	Finish	Product code	Price (£)
15mm Extension Profile	Silver	DS0000110	£70.00

Pier Sundries	Finish	Product code	Price (£)
Installation Kit Required when purchasing Inline and/or Side Panel	Silver	PIERBRACE	£205.00
Optional Closing Profile For use with Single Slider	Silver	PIERMAGNET	£65.00
Optional Bracing Bar	Silver	PI0000029	£65.00

Supreme Sundries	Finish	Product code	Price (£)
Corner Post	Silver	0105	£105.00
Wall Channel	Silver	7103	£65.00
32mm Square Profile (Up to 2 metres)	Silver	9315	£82.00
Luxury Pivot Door Handle	Silver	0112	£65.00
Bracing Bar	Silver	7258	£42.00

Ten Sundries	Finish	Product code	Price (£)
Spare Handle	Silver	10HANDLE	£140.00



BATH SCREENS

# step into luxury

*For rooms with limited space, go for an over-bath shower screen. From single panels to foldaway designs, there is a practical solution for those daily showering routines.*

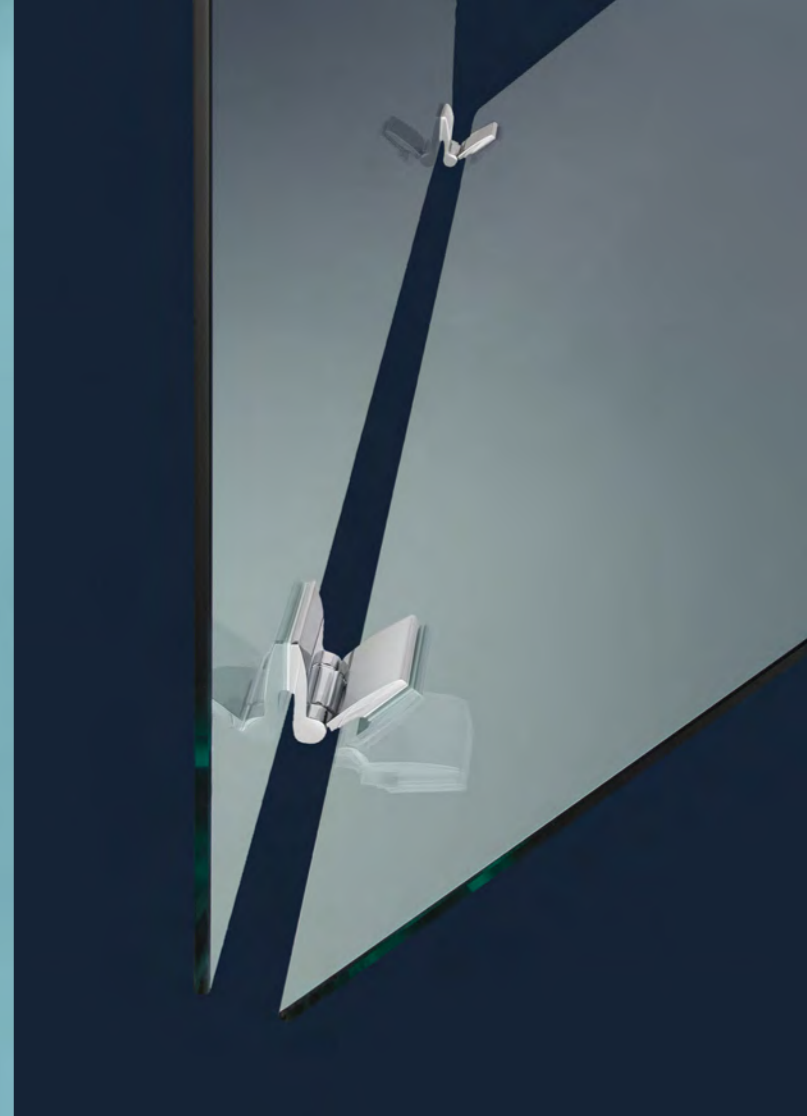

# Design+ Matt Black - Single

NEW

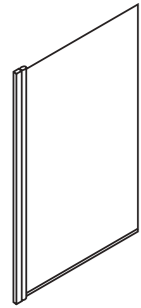

Semi-Frameless Single Bath Screen

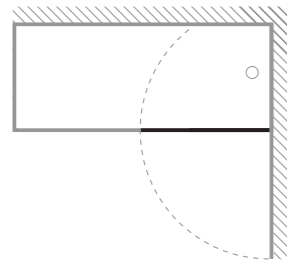

Bath Screen opening



# Design+ Matt Black - Double Panel

NEW

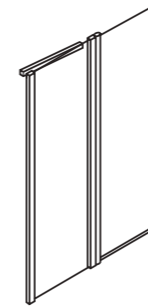

Semi-Frameless Double Bath Screen

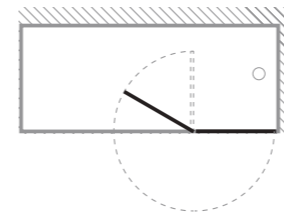

Bath Screen opening



- 6mm toughened glass
- 20mm adjustment for easy fitting
- 1500mm glass height
- Power shower proof
- Reversible design
- Screen rotates through 180°
- Matt Black finish frame
- Easy Clean - Crosswater Clear as standard
- Lifetime Guarantee
- Rise and fall pivot

Width	Adjustment	Product Code	PRICE (£)
<b>Single Bath Screen</b> 850mm	850 - 870	PBSBC0850	<b>NEW</b> £285.00

- 6mm toughened glass
- 20mm adjustment for easy fitting
- 1500mm glass height
- Power shower proof
- Reversible design
- Rotates 180° opening inwards and outwards
- Matt Black finish frame
- Easy Clean - Crosswater Clear as standard
- Lifetime Guarantee
- Rise and fall pivot

Width	Adjustment	Product Code	PRICE (£)
<b>Double Panel Bath Screen</b> 1060mm	1060 - 1080	PBDBC1060	<b>NEW</b> £430.00





# Design+ Matt Black - Double Folding

NEW

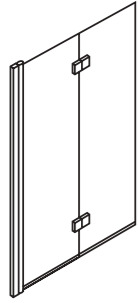



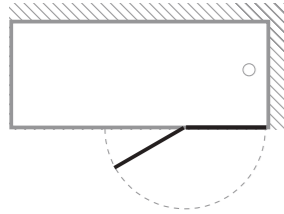





Semi-Frameless Double Bath Sscreen - Double Folding



Bath Screen opening



-  8mm toughened glass
-  20mm adjustment for easy fitting
-  1500mm glass height
-  Power shower proof
-  Reversible design
-  Matt Black finish frame
-  Easy Clean - Crosswater Clear as standard
-  Lifetime Guarantee

Width	Adjustment	Product Code	PRICE (£)
1060mm	1060 - 1080	PBVBC1060	<b>NEW</b> £585.00

crosswater<sup>®</sup>

# MPRO



beautifully coordinated  
brassware

SEE THE PREMIUM BRASSWARE BROCHURE FOR MORE DETAILS.



# Design+ - Single

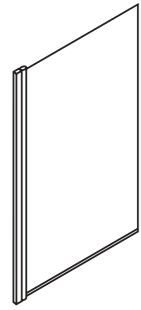

Semi-Frameless Single Bath Screen

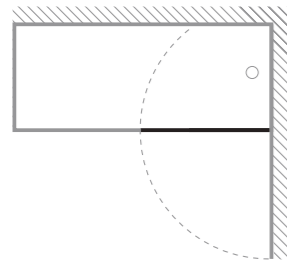

Bath Screen opening



# Design+ - Double - Outward Opening

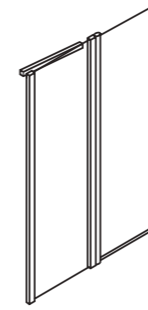



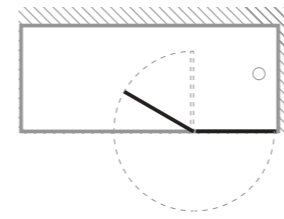







Semi-Frameless Double Bath Screen













Bath Screen opening



-  6mm toughened glass
-  20mm adjustment for easy fitting
-  1500mm glass height
-  Power shower proof
-  Reversible design
-  Screen rotates through 180°
-  Silver finish frame
-  Easy Clean - Crosswater Clear as standard
-  Lifetime Guarantee
-  Rise and fall pivot

Width	Adjustment	Product Code	PRICE (£)
<b>Single Bath Screen</b> 850mm	850 - 870	DBSSC0850	£239.00



-  6mm toughened glass
-  20mm adjustment for easy fitting
-  1500mm glass height
-  Power shower proof
-  Reversible design
-  Second panel rotates through 270°
-  Silver finish frame
-  Easy Clean - Crosswater Clear as standard
-  Lifetime Guarantee
-  Rise and fall pivot

Width	Adjustment	Product Code	PRICE (£)
<b>Double Bath Screen - Outward Opening</b> 1060mm	1060 - 1080	DBDSC1060+	£359.00

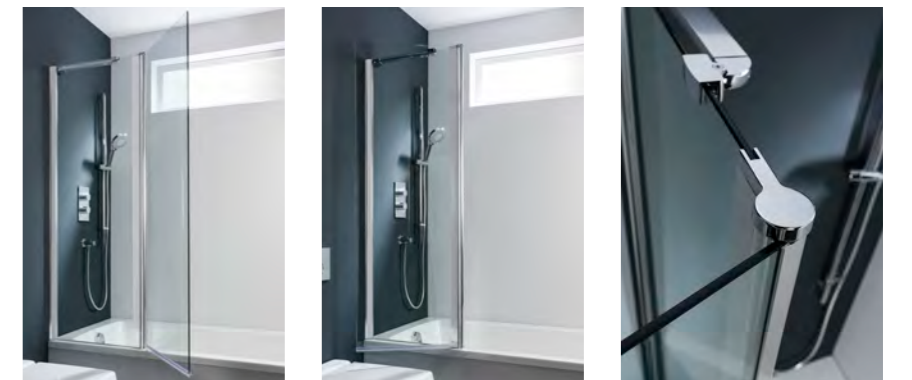

# Design+ - Double Folding

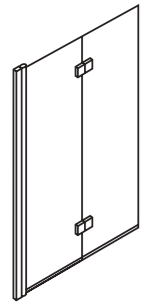

Semi-Frameless Double Bath Screen - Double Folding

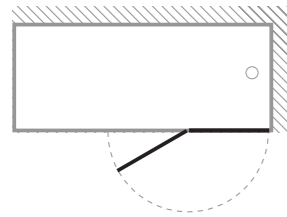

Bath Screen opening



# Design+ - Triple

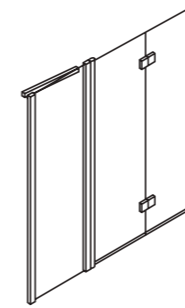

Semi-Frameless Triple Bath Screen

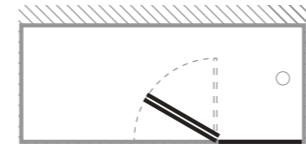
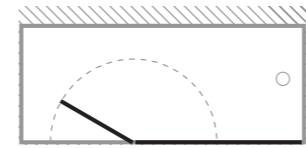

Bath Screen opening



- 6mm toughened glass
- 20mm adjustment for easy fitting
- 1500mm glass height
- Power shower proof
- Reversible design
- Rotates 180° opening inwards and outwards
- Silver finish frame
- Easy Clean - Crosswater Clear as standard
- Lifetime Guarantee
- Rise and fall pivot

Width	Adjustment	Product Code	PRICE (£)
<b>Double Folding Bath Screen</b> 1060mm	1060 - 1080	DBVSCI060+	£475.00



- 6mm toughened glass
- 20mm adjustment for easy fitting
- 1500mm glass height
- Power shower proof
- Reversible design
- Second panel rotates through 270°
- Silver finish frame
- Easy Clean - Crosswater Clear as standard
- Lifetime Guarantee
- Rise and fall pivot

Width	Adjustment	Product Code	PRICE (£)
<b>Triple Bath Screen</b> 1500mm	1500 - 1520	DBTSC1500+	£489.00



# Svelte - Single

NEW

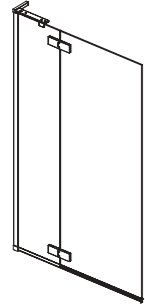



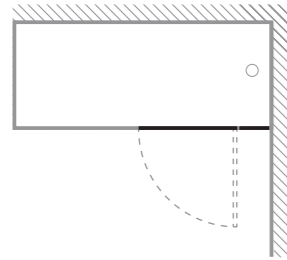





Semi-Frameless Single Bath Screen



Bath Screen opening



-  8mm toughened glass
-  15mm adjustment for easy fitting
-  1500mm glass height
-  Power shower proof
-  Reversible design
-  Polished stainless steel finish
-  Easy Clean - Crosswater Clear as standard
-  Lifetime Guarantee

Width	Adjustment	Product Code	PRICE (£)
<b>Single Bath Screen</b> 900mm	900 - 915	SBSSC0900	£535.00

# Infinity - Single

NEW

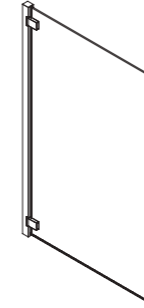

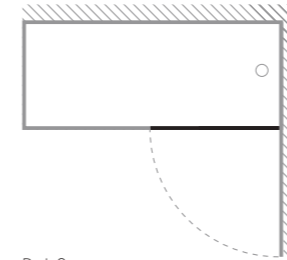

Semi-Frameless Single Bath Screen



Bath Screen opening



-  8mm toughened glass
-  20mm adjustment for easy fitting
-  1385mm glass height
-  Power shower proof
-  Reversible design
-  Polished stainless steel finish
-  Easy Clean - Crosswater Clear as standard
-  Lifetime Guarantee

Width	Adjustment	Product Code	PRICE (£)
<b>Single Bath Screen</b> 900mm	885 - 900	IBSSC0900	£395.00



# Ten - Hinged

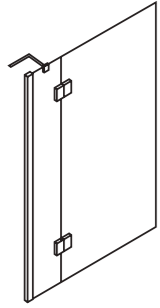

Hinged Bath Screen

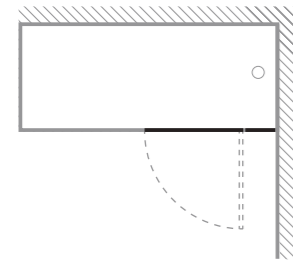

Bath Screen opening



# Zion - Hinged

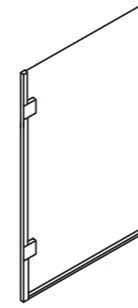



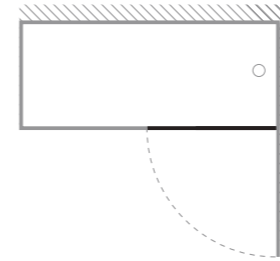





Hinged Bath Screen



Bath Screen opening



-   
10mm toughened glass
-   
15mm adjustment for easy fitting
-   
1500mm glass height
-   
Power shower proof
-   
Reversible design
-   
Outward opening only
-   
Silver finish frame
-   
Easy Clean - Crosswater Clear as standard
-   
Lifetime Guarantee

Width	Hinged Panel Width	Adjustment	Product Code	PRICE (£)
900mm	647	900 - 915	TBDS0900	£590.00



-   
10mm toughened glass
-   
1500mm glass height
-   
Power shower proof
-   
Reversible design
-   
Outward opening bath screen
-   
Chromed brass hinges
-   
Easy Clean - Crosswater Clear as standard
-   
Lifetime Guarantee
-   
Hinged directly from the wall

Width	Adjustment	Product Code	PRICE (£)
900mm	N/A	ZBSS0900	£525.00



# Click - Single

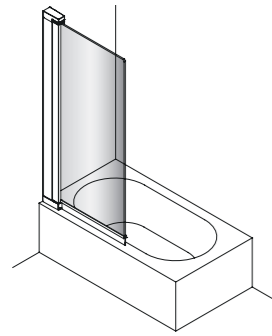

Single Bath Screen

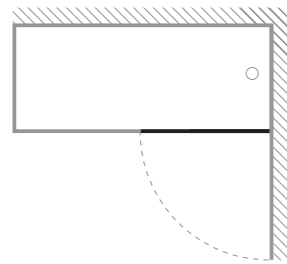

Bath Screen opening



# Click - Double

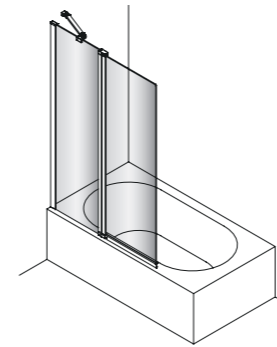



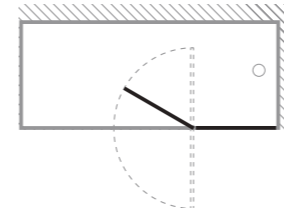







Double Bath Screen



Bath Screen opening









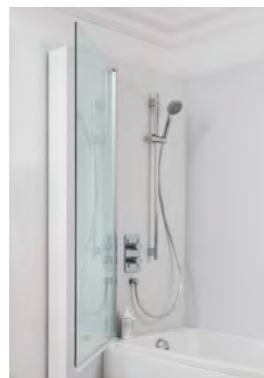





-  6mm toughened glass
-  20mm adjustment for easy fitting
-  1500mm glass height
-  Power shower proof
-  Reversible design
-  Outward opening bath screen
-  Silver profile finish
-  Easy Clean - Crosswater Clear as standard
-  Lifetime Guarantee
-  Click profile system
-  Rise and fall pivot

Width	Adjustment	Product Code	PRICE (£)
<b>Single Bath Screen</b>			
800mm	800 - 820	NBSSC0800	£250.00

To view an installation video for this product please visit [youtube.com/CrosswaterHoldings](https://www.youtube.com/CrosswaterHoldings)



-  6mm toughened glass
-  20mm adjustment for easy fitting
-  1500mm glass height
-  Power shower proof
-  Reversible design
-  Inward and outward opening bath screen
-  Silver profile finish
-  Easy Clean - Crosswater Clear as standard
-  Lifetime Guarantee
-  Fast installation wall channels
-  Rise and fall pivot
-  Squeeze gasket installation

Width	Adjustment	Product Code	PRICE (£)
<b>Double Bath Screen</b>			
1150mm	1150 - 1170	NBDSC1150	£310.00



# Click - Easy-Reach

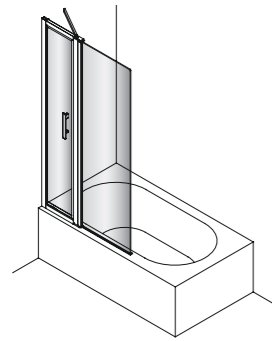

Easy-Reach Bath Screen

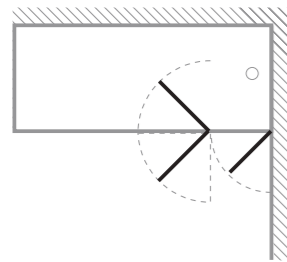

Bath Screen opening



# Edge - Foldaway

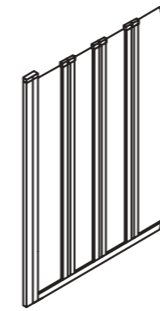



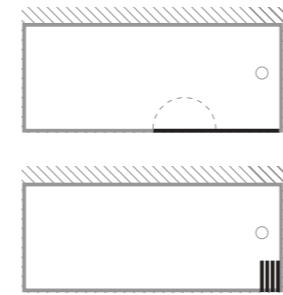







Foldaway Bath Screen









Bath Screen opening



-  6mm toughened glass
-  15mm adjustment for easy fitting
-  1450mm glass height
-  Power shower proof
-  Reversible design
-  Outward opening bath screen
-  Silver profile finish
-  Easy Clean - Crosswater Clear as standard
-  Lifetime Guarantee
-  Hinged door to access panel
-  Rise and fall pivot

Width	Adjustment	Product Code	PRICE (£)
<b>Easy-Reach Bath Screen</b> 850mm	850 - 865	NBSC0850	£340.00



-  4mm toughened glass
-  8mm adjustment for easy fitting
-  1382mm glass height
-  Reversible design
-  Folding bath screen
-  Silver finish frame
-  1 Year Guarantee

Width	Adjustment	Product Code	PRICE (£)
<b>Foldaway Bath Screen</b> 830mm (230mm Folded)	830 - 838	EFBSC0865	£335.00



# Supreme - Deluxe

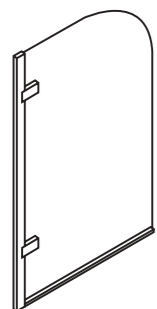

Deluxe Bath Screen

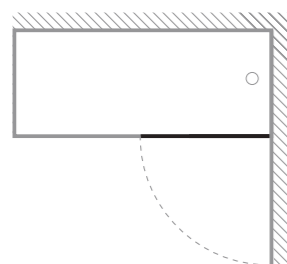

Bath Screen opening



# Supreme - Over-Bath Slider

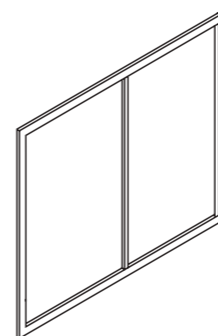

Over-Bath Slider



Bath Screen opening



- 5mm toughened glass
- 15mm adjustment for easy fitting
- 1380mm glass height
- Reversible design
- Outward opening only
- Silver profile finish
- Easy Clean - Crosswater Clear as standard
- 1 Year Guarantee
- Easy installation

Width	Adjustment	Product Code	PRICE (£)
<b>Deluxe Bath Screen</b>			
700mm	N/A	6019/6022	£195.00
850mm	N/A	6019/6021	£205.00



Operate both your bath filler and shower handset at the same time with a multifunction thermostatic valve.

See the Premium Brassware brochure for more information.

- 4mm toughened glass
- 60mm adjustment for easy fitting
- 1480mm glass height
- Power shower proof
- Reversible design
- Sliding doors
- Silver profile finish
- Easy Clean - Crosswater Clear as standard
- Lifetime Guarantee
- Easy installation

Width	Door Entry Width	Adjustment	Product Code	PRICE (£)
<b>Over-Bath Slider</b>				
1700mm	735	1646 - 1706	5301	£855.00



On a budget? There's a wide choice of cost-effective brassware solutions, like our Reflex single mode shower head.

See the Premium Brassware brochure for more information.





# Supreme - Bath Guard













Bath Guard



Bath Guard opening





-  5mm toughened glass
-  30mm adjustment for easy fitting
-  1280mm glass height
-  Reversible design
-  Fixed bath guard
-  Silver finish frame
-  Easy Clean - Crosswater Clear as standard
-  Lifetime Guarantee
-  Easy installation
-  To be used in conjunction with a shower curtain

Width	Door Entry Width	Adjustment	Product Code	PRICE (£)
210mm			7038	£125.00
350mm			6036	£155.00

# Folding Shower Seat

The Square Wall Mounted shower seat is designed to fit all Crosswater enclosures, and conveniently folds away when not in use.



-  Stainless Steel
-  Easy to install
-  Quality construction

Depth x Width	Product Code	PRICE (£)
<b>Square Wall Mounted Shower Seat</b> 360 x 360mm	SEATSQ	£335.00

**Must be fixed to a solid wall. Maximum weight 150kg.**



Open position



Folded position



SHOWER TRAYS & WET ROOMS

# walk-in style









*An extensive range of high quality, specialist shower tray solutions, catering to all room sizes and requirements for both shower enclosures and wet rooms.*



# 30mm PLUS+TON® Ceramic Shower Trays

Patent No. AN2014A000135

Self cleaning vortex waste offering a maintenance-free solution as it doesn't require any cleaning.

-  100% ceramic fine fire clay
-  30mm low profile
-  Scratch-proof
-  Stain-proof
-  Limescale-proof
-  Bacterial resistant
-  Reversible
-  Lifetime Guarantee

## High Flow Waste

The PLUS+TON® waste must be used with PLUS+TON® trays.  
 PTHFWSO90 (33lpm) £45.00

## Special ceramic waste cover

All trays are fitted with a special ceramic waste cover, featuring a factory fitted aluminium insert with rubber feet that fits exactly in to the insert holes. Once fitted the waste cover is rock solid, further enabling the innovative features and benefits of the tray.

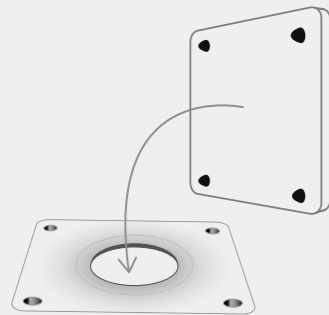

(shown opposite)

## Rectangular 30mm PLUS+TON® Matt White Ceramic Shower Tray



Size	Product Code	PRICE (£)
800 x 1200 x 30mm	PTOR8120WM	£955.00
800 x 1400 x 30mm	PTOR8140WM	£1,130.00
800 x 1700 x 30mm	PTOR8170WM	£1,365.00
900 x 1200 x 30mm	PTOR9120WM	£1,070.00
900 x 1400 x 30mm	PTOR9140WM	£1,255.00
900 x 1700 x 30mm	PTOR9170WM	£1,545.00

## Rectangular 30mm PLUS+TON® Matt Black Ceramic Shower Tray



Size	Product Code	PRICE (£)
800 x 1200 x 30mm	PTOR8120BM	£955.00
800 x 1400 x 30mm	PTOR8140BM	£1,130.00
800 x 1700 x 30mm	PTOR8170BM	£1,365.00
900 x 1200 x 30mm	PTOR9120BM	£1,070.00
900 x 1400 x 30mm	PTOR9140BM	£1,255.00
900 x 1700 x 30mm	PTOR9170BM	£1,545.00

\*Made to special order, please contact our sales office. Once ordered these products cannot be cancelled or returned.

SCRATCH-PROOF



STAIN-PROOF



REVERSIBLE DESIGN



ECO-FRIENDLY



BACTERIAL RESISTANT

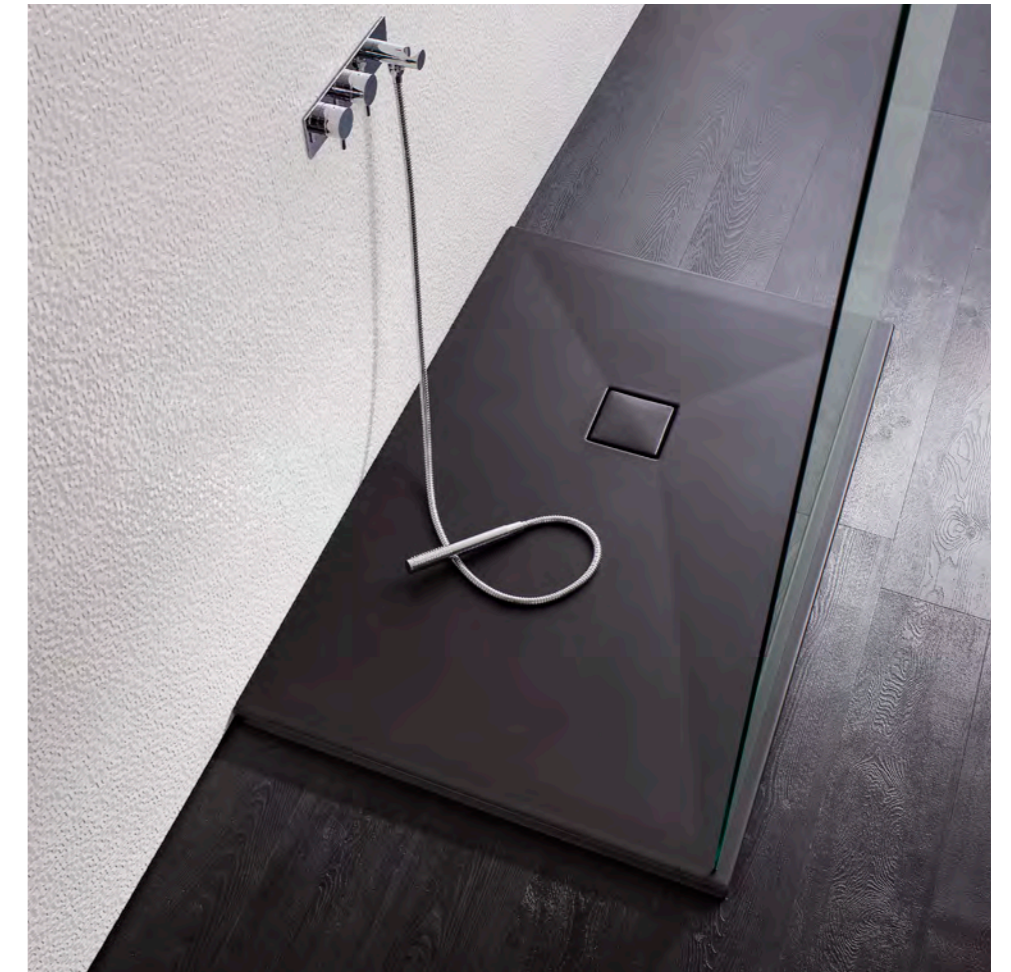

## Scratch-proof BRILLIANT ENDURING FINISH

The surface of the PLUS+TON® shower tray is 100% scratch-proof and guaranteed to keep the same brilliancy of finish as the day it was installed. Each tray is rigorously tested against abrasion and scratching; time and time again tests prove perfect resistance properties that exceed the requirements of the current industry standards. Simply clean scratches with a scouring pad and water.



## Bacteria resistant ERADICATE GERMS

On average there is more bacteria on one hand than people on earth! On non-protected areas the number of bacteria can double every 20 minutes. PLUS+TON® include Bacterclean® as standard, a revolutionary non-toxic antibacterial treatment, achieved by the high temperature glaze process. Bacterclean® complies with the world's most stringent quality standard JIS Z 2801:2000 (ISO 22196:2007), ensuring the development of pathogenic agents such as E-Coli, Staphylococcus or Streptococcus are eliminated by up to 99%. Providing you with peace of mind that you have the very best showering base available in the UK today.

## Reversible VERSATILE DESIGN

With a thickness of only 30mm, the PLUS+TON® shower tray is extremely easy to handle. With its fully glazed sides, it's completely reversible and can be installed in any bathroom environment, adjacent to walls, in the centre of the room or to follow modern trends flush to the floor, making the showering area also accessible to those with disabilities.

## Limescale & STAIN PROOF



Whether you're dyeing your hair or painting your nails in the bathroom, any spills can be cleared up within 72 hours and will leave no staining.

INK	72 HRS
HAIR DYE	72 HRS
NAIL POLISH	72 HRS
HYDROCHLORIC ACID	16 HRS
SILVER NITRATE	72 HRS
LODINE DYE	72 HRS
METHYLENE BLUE	72 HRS
POTASSIUM PERMANGANATE	72 HRS



# 25mm Storm Grey Stone Resin Shower Trays

Manufactured by hand in the UK from the finest natural materials

At only 25mm high, the tray can be installed as a level access solution

Durable and repairable gloss gel coat finish

Easy clean 90mm vortex waste, delivering up to 30 litres a minute

High flow waste included



100% natural stone resin with gloss finish



25mm ultra low profile



Lifetime Guarantee

## Rectangular 25mm Storm Grey Stone Resin Shower Tray



Size	Product Code	PRICE (£)
800 x 1000 x 25mm	SG0R81000	£320.00
800 x 1200 x 25mm	SG0R81200	£340.00
800 x 1400 x 25mm	SG0R81400	£480.00
800 x 1700 x 25mm	SG0R81700	£510.00
900 x 1200 x 25mm	SG0R91200	£370.00
900 x 1400 x 25mm	SG0R91400	£480.00
900 x 1700 x 25mm	SG0R91700	£510.00

## Square 25mm Storm Grey Stone Resin Shower Tray



Size	Product Code	PRICE (£)
800 x 800 x 25mm	SG000S800	£310.00
900 x 900 x 25mm	SG000S900	£320.00

## Quadrant 25mm Storm Grey Stone Resin Shower Tray



Size	Product Code	PRICE (£)
900 x 900 x 25mm	SG000Q900	£315.00



# 25mm Stone Resin Shower Trays

The minimalist Slab tray is manufactured by hand in the UK from the finest natural materials

The Slab is load bearing and is installed the same way as any standard stone resin shower tray

Bespoke 90mm easy clean waste and stainless steel cover is supplied as standard for the ultimate minimal look, delivering upto 30 litres a minute drainage

For fitting on concrete or wooden floors (comprehensive fitting instructions included)

A tough gel coat smooth surface, durable, repairable and easy clean

At only 25mm high, the tray can be installed as a level access solution

Optional upgrade to Chrome cover available (STGRID\_C £40.00) or Matt Black (STGRID\_MB £40.00)

Waste included



100% natural stone resin



25mm ultra low profile



Lifetime Guarantee

## Rectangular 25mm Stone Resin Shower Tray & Waste



Size	Product Code	PRICE (£)
700 x 1200 x 25mm	SLOR7001200	£265.00
700 x 1700 x 25mm	SLOR7001700	£430.00
760 x 1000 x 25mm	SLOR71000	£260.00
760 x 1200 x 25mm	SLOR71200	£270.00
760 x 1400 x 25mm	SLOR71400	£405.00
760 x 1500 x 25mm	SLOR71500	£415.00
760 x 1600 x 25mm	SLOR71600	£425.00
760 x 1700 x 25mm	SLOR71700	£435.00
800 x 1000 x 25mm	SLOR81000	£250.00
800 x 1100 x 25mm	SLOR81100	£260.00
800 x 1200 x 25mm	SLOR81200	£270.00
800 x 1400 x 25mm	SLOR81400	£405.00
800 x 1500 x 25mm	SLOR81500	£415.00
800 x 1600 x 25mm	SLOR81600	£425.00
800 x 1700 x 25mm	SLOR81700	£435.00
900 x 1000 x 25mm	SLOR91000	£250.00
900 x 1100 x 25mm	SLOR91100	£260.00
900 x 1200 x 25mm	SLOR91200	£280.00
900 x 1400 x 25mm	SLOR91400	£405.00
900 x 1500 x 25mm	SLOR91500	£415.00
900 x 1600 x 25mm	SLOR91600	£425.00
900 x 1700 x 25mm	SLOR91700	£435.00

## Square 25mm Stone Resin Shower Tray & Waste



Size	Product Code	PRICE (£)
800 x 800 x 25mm	SL000S800	£240.00
900 x 900 x 25mm	SL000S900	£250.00

## Quadrant 25mm Stone Resin Shower Tray & Waste



Size	Product Code	PRICE (£)
800 x 800 x 25mm	SL000Q800	£240.00
900 x 900 x 25mm	SL000Q900	£250.00

## Offset quadrant 25mm Stone Resin Shower Tray & Waste



Right hand tray shown

Size	Product Code	PRICE (£)
800 x 1000 x 25mm (L)	SLO81000L	£340.00
800 x 1000 x 25mm (R)	SLO81000R	£340.00
800 x 1200 x 25mm (L)	SLO81200L	£360.00
800 x 1200 x 25mm (R)	SLO81200R	£360.00
900 x 1200 x 25mm (L)	SLO91200L	£400.00
900 x 1200 x 25mm (R)	SLO91200R	£400.00

## Optional Waste Cover Upgrades

Chrome - To be used with 25mm Stone resin trays	STGRID_C	£40.00
Matt Black - To be used with 25mm Stone resin trays	STGRID_MB	£40.00

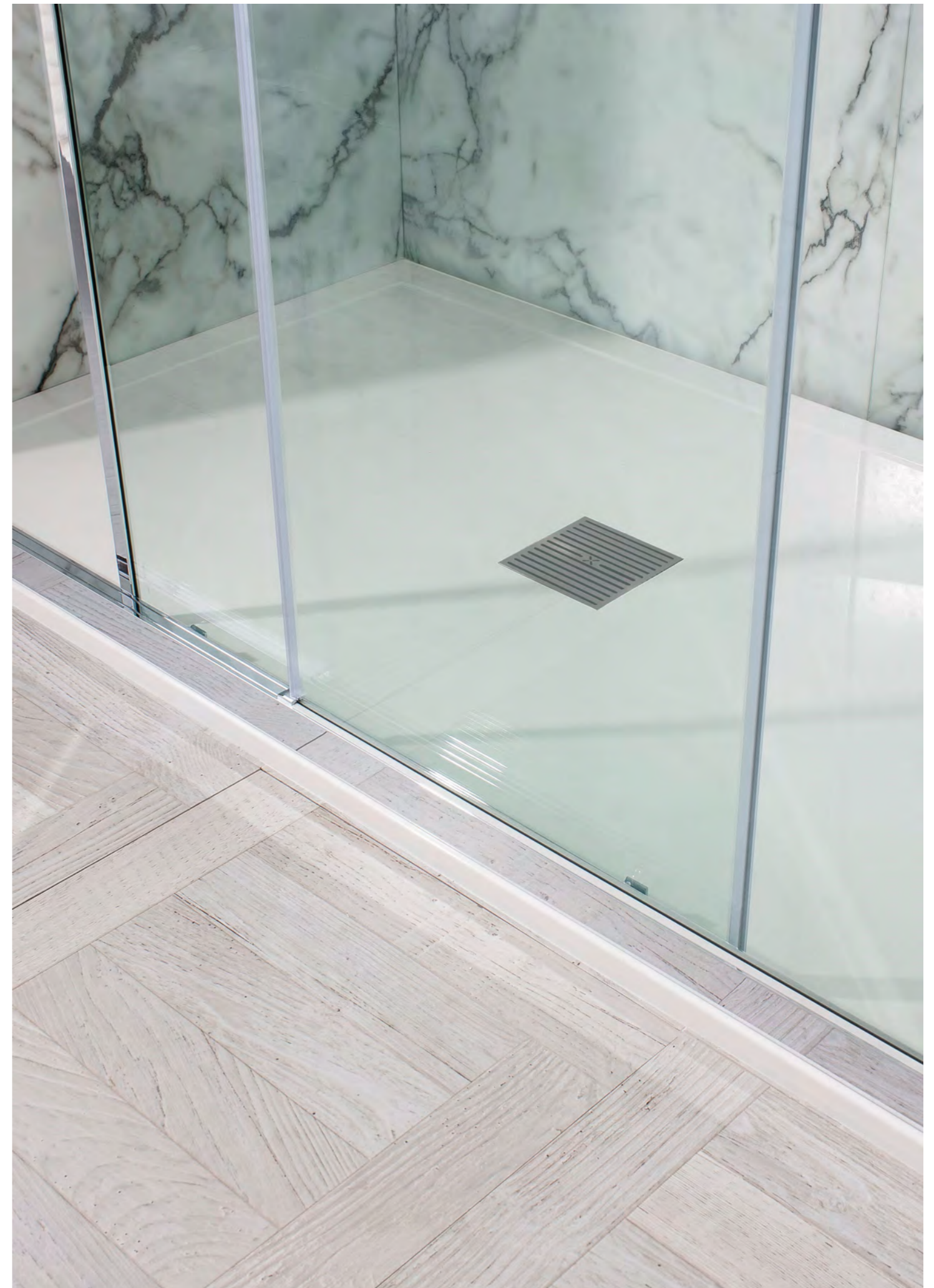

# 25mm Stone Resin Shower Trays with Linear Waste

The minimalist Slab tray is manufactured by hand in the UK from the finest natural materials

The Slab is load bearing and is installed the same way as any standard stone resin shower tray

For fitting on concrete or wooden floors (comprehensive fitting instructions included)

A tough gel coat smooth surface, durable, repairable and easy clean

Stainless steel waste grid that is only 75mm wide, the tray still has an incredible drainage efficiency of over 30 litres of water per minute

At only 25mm high, the tray can be installed as a level access solution

Tray comes complete with a stainless steel flush fitting waste cover finished in white

Optional upgrade to Chrome cover available (LNGRID\_C £45.00) or Matt Black (LNGRID\_MB £45.00)

The waste design creates a self cleaning vortex for high water clearing performance



100% natural stone resin



25mm ultra low profile



Lifetime Guarantee

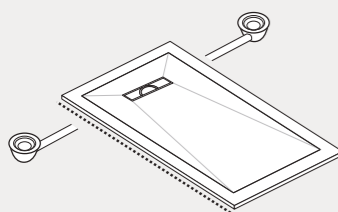

The waste outlet can now be fitted left and right making installation easier.

## Rectangular 25mm Stone Resin Shower Tray with Linear Waste



Size	Product Code	PRICE (£)
800 x 1000 x 25mm	LNOR81000	£295.00
800 x 1200 x 25mm	LNOR81200	£325.00
800 x 1400 x 25mm	LNOR81400	£475.00
800 x 1500 x 25mm	LNOR81500	£480.00
800 x 1700 x 25mm	LNOR81700	£520.00
900 x 1200 x 25mm	LNOR91200	£335.00
900 x 1400 x 25mm	LNOR91400	£480.00
900 x 1500 x 25mm	LNOR91500	£485.00
900 x 1700 x 25mm	LNOR91700	£530.00

## Square 25mm Stone Resin Shower Tray with Linear Waste



Size	Product Code	PRICE (£)
900 x 900 x 25mm	LN000S900	£290.00

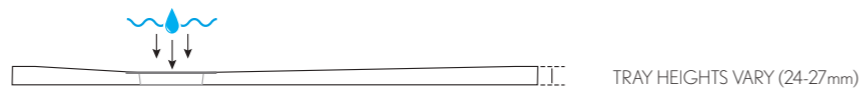

THE WASTE POSITION OFFSET MAXIMIZING STANDING AREA IN THE SHOWER

## Waste Cover Upgrades

Chrome LNGRID\_C £45.00  
Matt black LNGRID\_MB £45.00



# 25mm Kai & Anti-Slip Stone Resin Shower Trays

Manufactured by hand in the UK from the finest natural materials

Unique leg set for easy installation

Durable and repairable gel coat finish

Easy clean 90mm vortex waste delivering up to 30 litres a minute

High flow waste

Waste must be used with Kai and Anti-slip 25mm trays ATHFWSQ90

Anti-slip trays conform to BS7976-2 Market leading anti-slip rating

Lifetime Anti-slip guarantee

Easy clean surface



100% natural stone resin



25mm ultra low profile



Lifetime Guarantee

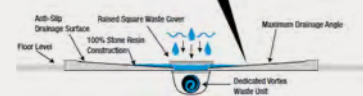
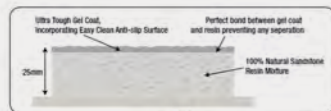

## Rectangular 25mm Kai Stone Resin Shower Tray



Size	Product Code	PRICE (£)
800 x 1000 x 25mm	KLR8X1000	£190.00
800 x 1200 x 25mm	KLR8X1200	£200.00
800 x 1400 x 25mm	KLR8X1400	£310.00
800 x 1700 x 25mm	KLR8X1700	£360.00
900 x 1200 x 25mm	KLR9X1200	£210.00
900 x 1400 x 25mm	KLR9X1400	£320.00
900 x 1700 x 25mm	KLR9X1700	£365.00



Anti-slip

700 x 1700 x 25mm	ATR7X1700	£425.00
800 x 1000 x 25mm	ATR8X1000	£250.00
800 x 1200 x 25mm	ATR8X1200	£270.00
800 x 1400 x 25mm	ATR8X1400	£365.00
800 x 1700 x 25mm	ATR8X1700	£445.00
900 x 1200 x 25mm	ATR9X1200	£275.00
900 x 1400 x 25mm	ATR9X1400	£385.00
900 x 1700 x 25mm	ATR9X1700	£465.00

## Square 25mm Kai Stone Resin Shower Tray



Size	Product Code	PRICE (£)
800 x 800 x 25mm	KLS800	£150.00
900 x 900 x 25mm	KLS900	£160.00

800 x 800 x 25mm	ATS800	£195.00
900 x 900 x 25mm	ATS900	£205.00

## Quadrant 25mm Kai Stone Resin Shower Tray



Size	Product Code	PRICE (£)
900 x 900 x 25mm	KLQ900	£175.00
900 x 900 x 25mm	ATQ900	£220.00

## Required waste

Must be used with 25mm Kai and Anti-slip stone resin shower trays ATHFWSQ90 £45.00

## Optional chrome waste

Must be used with 25mm Kai and Anti-slip stone resin shower trays - chrome finish D25CHROMESQCOVER £22.80

## Optional 25mm Kai & Anti-Slip Tray Leg Sets

Square leg set to suit 760-900	LEGSS76900	£65.00
Rectangular leg set to suit 1000-1200	LEGSR10120	£75.00
Rectangular leg set to suit 1400-1700	LEGSR14170	£85.00
Quadrant leg set to suit 800-1200	LEGSQ81200	£85.00

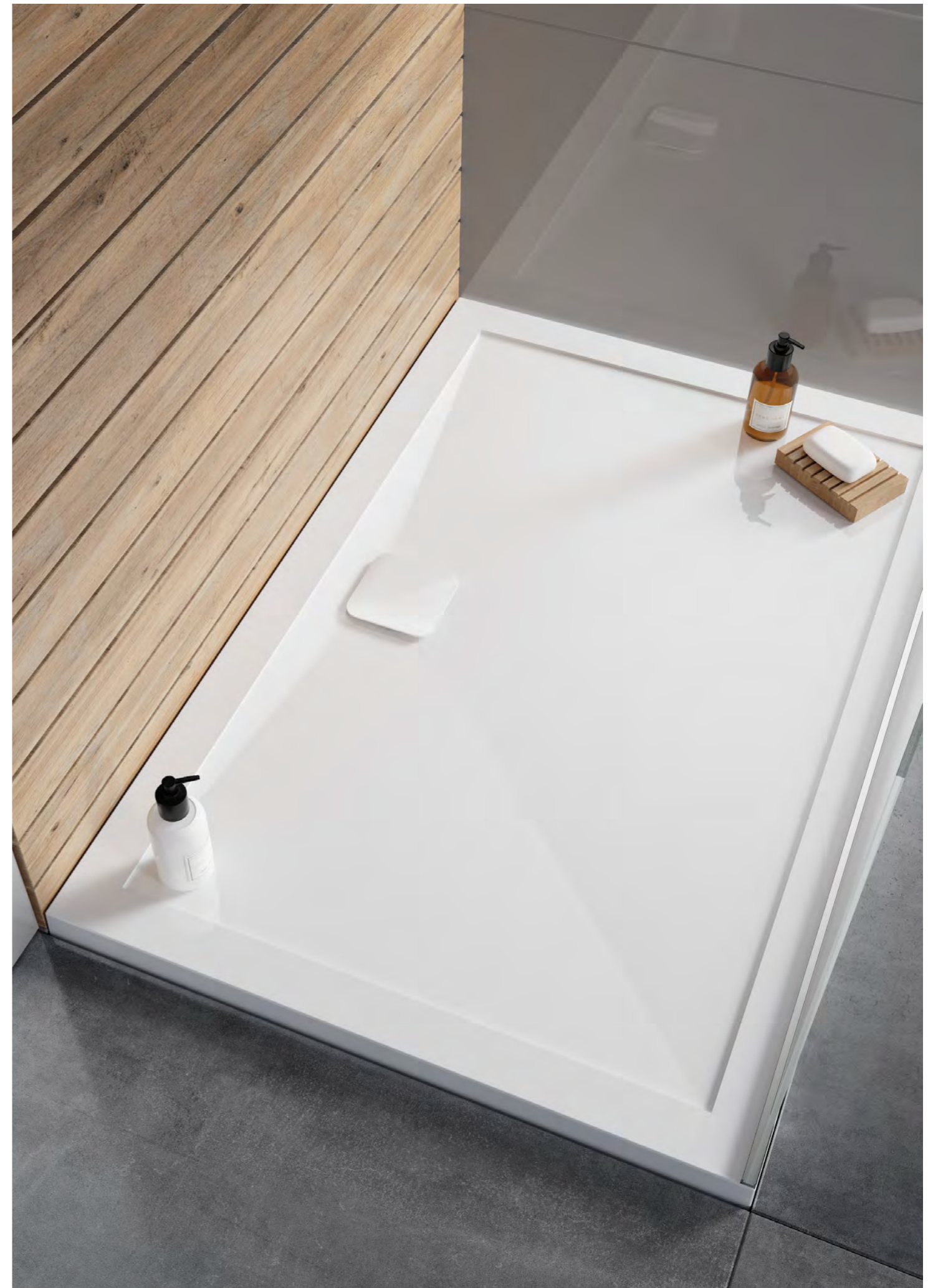
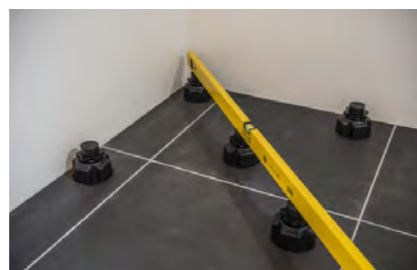

# 45mm Stone Resin Shower Trays

White surface has anti-bacterial properties

Waste on quads is offset so that unobstructive when entering and exiting the showering area

New rear construction for easy fit leg system

Direct to floor or raised installation application on each tray

EN14527:2006 Class 1 compliant

EN15720:2009 compliant

90mm waste outlet

Leg set and panels available, see opposite page

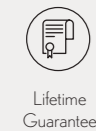
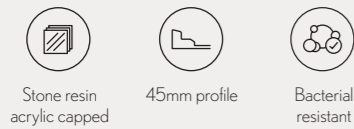

## Tray profile

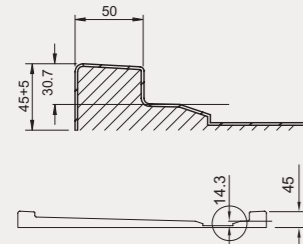

## High Flow Waste

Crosswater shower trays must only be used in conjunction with the Crosswater High Flow Waste.

Silver STHFW6190 £26.00



## Rectangular 45mm Stone Resin Shower Tray



Size	Product Code	PRICE (£)
800 x 1000mm	SROR81000	£209.00
800 x 1100mm	SROR81100	£209.00
700 x 1200mm	SROR7001200	£229.00
760 x 1200mm	SROR71200	£219.00
800 x 1200mm	SROR81200	£229.00
900 x 1200mm	SROR91200	£259.00
800 x 1400mm	SROR81400	£309.00
900 x 1400mm	SROR91400	£339.00
800 x 1500mm	SROR81500	£339.00
900 x 1500mm	SROR91500	£339.00
700 x 1600mm	SROR7001600	£379.00
800 x 1600mm	SROR81600	£369.00
900 x 1600mm	SROR91600	£369.00

## Square 45mm Stone Resin Shower Tray



Size	Product Code	PRICE (£)
760 x 760mm	SR0005760	£119.00
800 x 800mm	SR0005800	£149.00
900 x 900mm	SR0005900	£169.00

## Quadrant 45mm Stone Resin Shower Tray



Size	Product Code	PRICE (£)
800 Quad	SR000Q800	£169.00
900 Quad	SR000Q900	£179.00
550 x Radius		

## Offset Quadrant 45mm Stone Resin Shower Tray



Above: Right hand tray

Size	Product Code	PRICE (£)
800 x 1000mm Quad (R)	SRQ81000RH	£229.00
800 x 1000mm Quad (L)	SRQ81000LH	£229.00
800 x 1200mm Quad (R)	SRQ81200RH	£249.00
800 x 1200mm Quad (L)	SRQ81200LH	£249.00
900 x 1200mm Quad (R)	SRQ91200RH	£299.00
900 x 1200mm Quad (L)	SRQ91200LH	£299.00
550 x Radius		

# Shower Tray Frames & Panels

## 45mm Shower Tray - Leg/Panel Riser Kit



Shower Tray added



Tray showing leg set installed



Panels and tray configuration

Description	Size	Product Code	PRICE (£)
Rectangular Panel riser kit (inc feet)	900 x 1685mm	SRRP91680	£90.00
Quadrant panel riser kit (inc feet)	900 x 900mm	SRRPQ900	£100.00
Quadrant panel riser kit (inc feet)	900 x 1200mm	SRRPQ91200	£100.00

**raised frames**

*For ease of installation, our tray frame, panel and leg sets allow for shower plumbing to be stored above floor level.*





# Wet Rooms

*All of our wet room products are manufactured from the highest-quality structural hard foam, which is water resistant, superior in thermal qualities and has a special mortar coating with glass fibre reinforcement.*

Level Access Trays	130
Linea Level Access Shower Trays	132
Panels & Installation Components	134
Level Access Installation	136



# Level Access Trays

30mm low profile shower trays allow the easy installation of level access wet rooms in any domestic application

Improved thermal insulation

Eco-friendly product

30mm

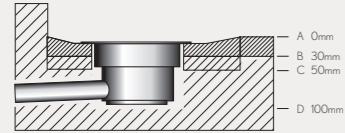

A 0mm  
B 30mm Shower tray / floor panel 20/30mm  
C 50mm Support panel 20mm  
D 100mm Waste space

40mm

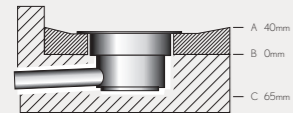

A 40mm Shower base 30/40mm  
B 0mm  
C 65mm Waste space

## Wet room SHOWER TRAYS

High compression strength of 10 tonnes per m<sup>2</sup> making it incredibly strong when tiled

High insulation qualities

Perfect gradients

Ideal for concrete or timber floors

Compatible with undertile heating

Easy to fit modular construction

Choice of base shapes, styles and sizes

Choice of waste styles and cover designs

Shower trays can be reduced by 100mm

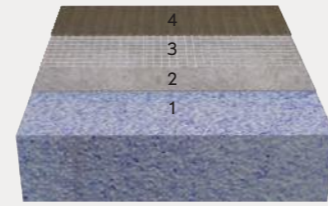

1. Polystyrene hard foam
2. Contact mortar layer
3. Glass fibre fabric
4. Coating mortar layer

### Level Access Shower Tray 30mm Centre Drain

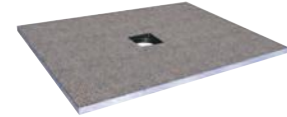

Depth x Width x Height

1200 x 900 x 30mm

1600 x 900 x 30mm

Product Code

WRST12X9LCE

WRST16X9LCE

PRICE (£)

£605.00

£655.00

For installation components, see page 134.

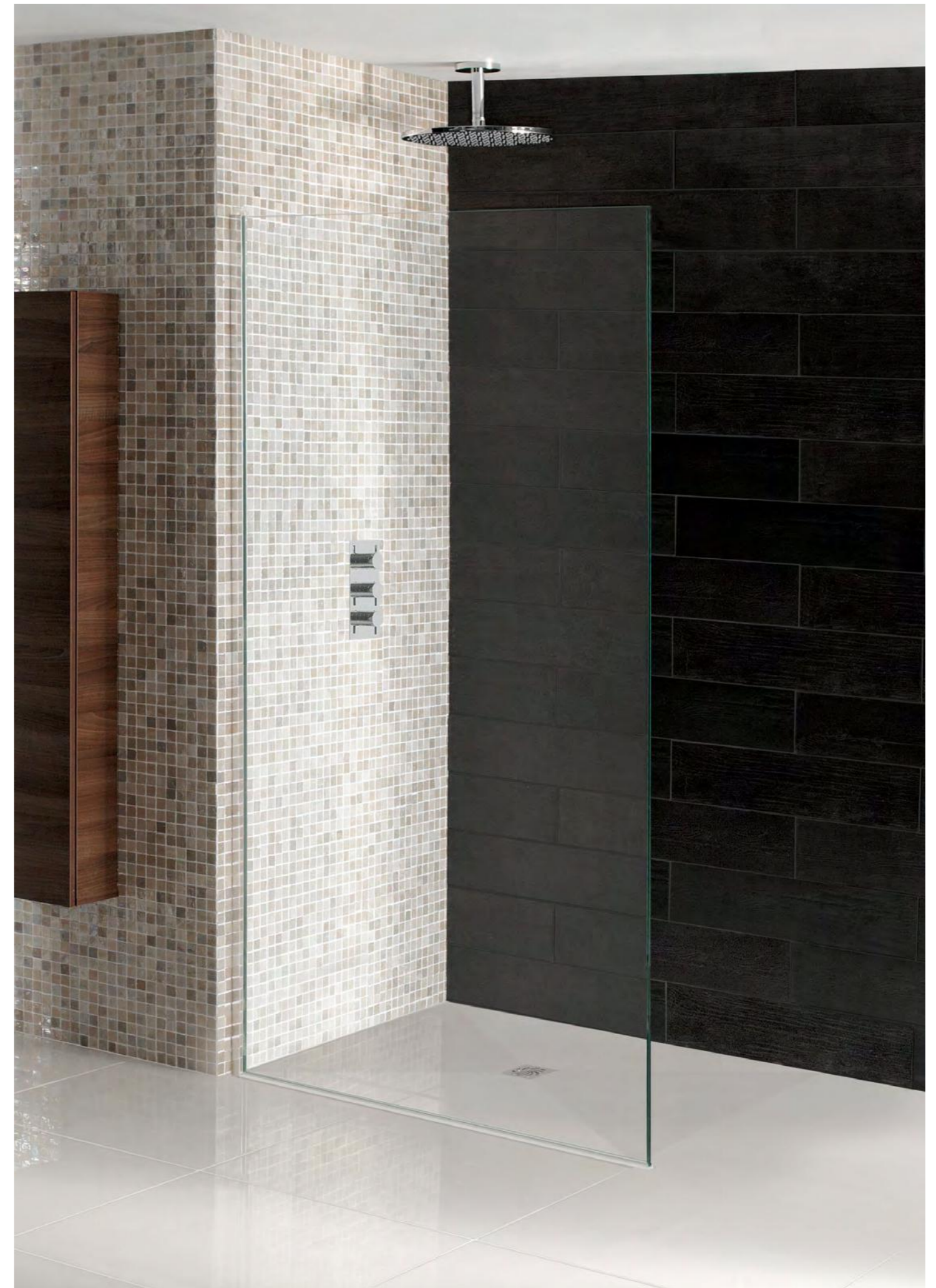

Shown right: 1200mm Glass Panel. Wet room Level Access Shower Tray 1200 x 900mm. Wet room Standard Horizontal Waste. Contour Shower Head. Elite Furniture. To see our full range visit [www.crosswater.co.uk](http://www.crosswater.co.uk)



# Linea Level Access Shower Trays

Increases the insulation value within the bathroom, reducing heat requirement and condensation

15mm gradient

## Wet room SHOWER TRAYS

High compression strength of 10 tonnes per m<sup>2</sup> making it incredibly strong when tiled

High insulation qualities

Perfect gradients

Ideal for concrete or timber floors

Compatible with undertile heating

Easy to fit modular construction

Choice of base shapes, styles and sizes

Choice of waste styles and cover designs

Shower trays can be reduced by 100mm

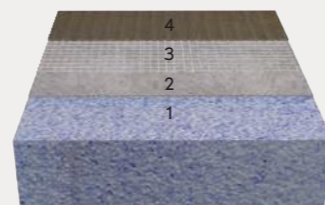

1. Polystyrene hard foam
2. Contact mortar layer
3. Glass fibre fabric
4. Coating mortar layer

### Linea Shower Trays 30mm End Drain



Depth x Width x Height	Product Code	PRICE (£)
900 x 900 x 30mm	WRLT0900E	£495.00
1200 x 900 x 30mm	WRLT12X9E	£595.00
1600 x 900 x 30mm	WRLT16X9E	£615.00

### Required Installation Components



<b>Universal Shower Tray Installation Kit</b>	WRSTINSTALL	£145.00
1 x Pro-Seal Premix 0.5l		
1 x 5kg Fixing Adhesive		
1 x 5m Waterproof Sealing Tape		
2 x Waterproof Internal Corners		
1 x 250ml Wood Floor Primer		



<b>Horizontal Trap &amp; Waste for Linea Drain</b>	WRHLIWASTE	£65.00
Suitable for Linea tray only		



<b>Linea Drain Stainless Steel Cover Plate</b>	WRSSPLATE	£65.00
--	-----------	--------

### Optional components

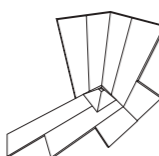

**Wall / Floor Panels**  
We advise using panels in all wet areas to ensure both your walls and floor remain fully water resistant, see page 134 for details.

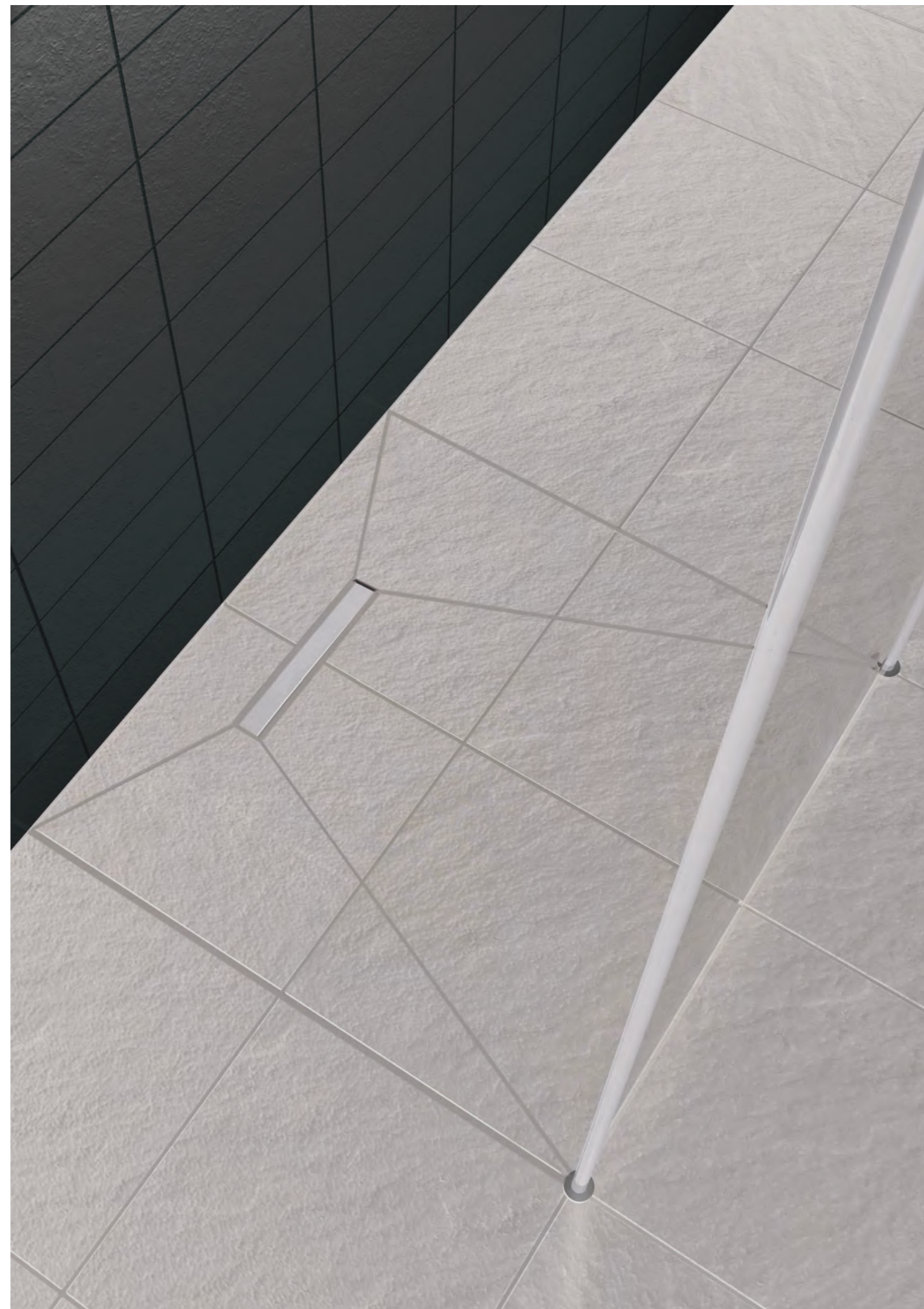

Shown right: 900 x 900mm Linea shower tray with end drain and Stainless Steel Cover Plate. To see our full range visit [www.crosswater.co.uk](http://www.crosswater.co.uk)



# Panels & Installation Components

## Panels

High compression strength of 10 tonnes per m<sup>2</sup> making it incredibly strong when tiled

Insulating product reducing condensation

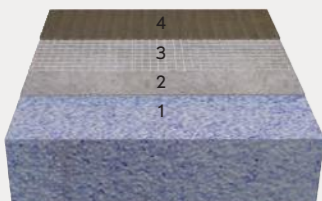

1. Polystyrene hard foam
2. Contact mortar layer
3. Glass fibre fabric
4. Coating mortar layer

## 2440mm Panel

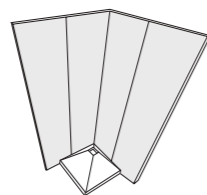

Depth x Width x Height	Product Code	PRICE (£)
600 x 2440 x 10mm	WRBDO10	£95.00

Tile weight - One of the great features of Crosswater Wet rooms is its strong adherence to tiles using approved cement based adhesives. This makes Crosswater Wet rooms an ideal product to use with heavy tiles such as natural stone. Dependant on the size of the tiles, Crosswater Wet rooms is suitable for tiles up to 50kg per m<sup>2</sup>. Please ensure the appropriate adhesives and tapes are used in the installation of all Crosswater Wet room products. Failure to do so will invalidate the product guarantee. See page opposite for fixings and adhesives.

## Bath Panels

Panels are preformed with adjustable legs

Easy to cut down to size

Faster to install than timber panelling

## Bath Panels



Depth x Width x Height	Product Code	PRICE (£)
Bath Panel for Bath Tub up to 1795mm 1795 x 600 x 30mm	WR1785BP	£105.00

Please ensure the appropriate adhesives and tapes are used in the installation of all Crosswater Wet room products. Failure to do so will invalidate the product guarantee. See page opposite for fixings and adhesives.

## Shower Tray Installation Kit



- 1 x Pro-Seal Premix 0.5l
- 1 x 5kg Fixing Adhesive
- 1 x 5m Waterproof Sealing Tape
- 2 x Waterproof Internal Corners
- 1 x 250ml Wood Floor Primer
- WRSTINSTALL £145.00

## Waterproof Tapes



- 120mm x 10m Roll Waterproof Sealing Tape
- WRTAPE10 £65.00

## Standard Horizontal Trap & Waste



- Standard Horizontal Trap inc. stainless steel grate
- Universal height adjustment.
- WRHSCWASTE £65.00

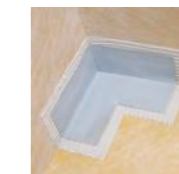

- Waterproof Internal Corner
- WRINTCOR £20.00

## Linea Tray Horizontal Trap & Waste



- Suitable for Linea tray only.
- WRHLIWASTE £65.00



- Linea Drain Stainless Steel Cover Plate
- WRSSPLATE £65.00

## Adhesives



- 5kg Fix-KST Fixing Adhesive
- WRADH05KG £40.00

- 20kg Fix-KST Fixing Adhesive
- WRADH20KG £85.00



- FIX-MD Mounting & Sealing Adhesive
- 310g per cartridge
- WRFLEXADH £45.00



- 12L Pro-Seal Premix Tape Sealing Compound for 10-12m tape
- WRTSC1012 £65.00



- Wood Floor Primer, 1L
- WRPRIMER1L £45.00

## Fixings



- 50 x Galvanised Fixing Washer 35mm
- WRO35FIXW £22.50



- 50 x Fitting Set With Screw (45mm) & Washer (35mm)
- WRO45FIXS £22.50



# Level Access Installation

## Wood Floors

Fixing a level access wet room onto a traditionally constructed board and joist floor is straightforward but it's recommended the work is carried out by a qualified professional. A feasibility site survey should also be carried out in advance to ascertain the length, direction of the waste and joists etc.



1. Remove floorboards to the nearest joist where the shower tray will be located.



2. Install the waste ensuring adequate run off.



3. Fix timber supports in between joists - these should be fixed low enough to bring your timber panels to the top of the joist.

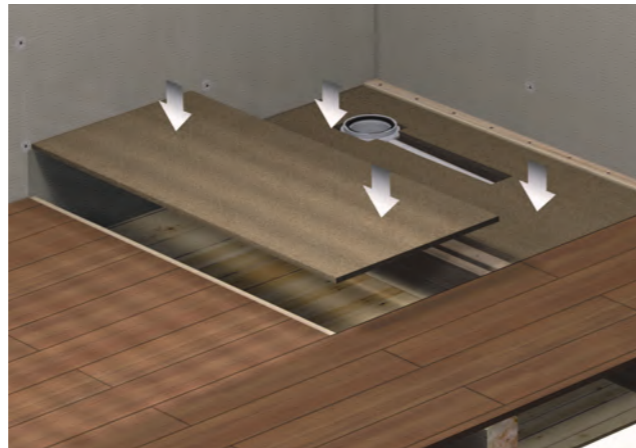

4. Fix timber panels to support ensuring a level deck at joist height.



5. Fit shower tray and floor panels to entire floor area using board fixing adhesive and screws.

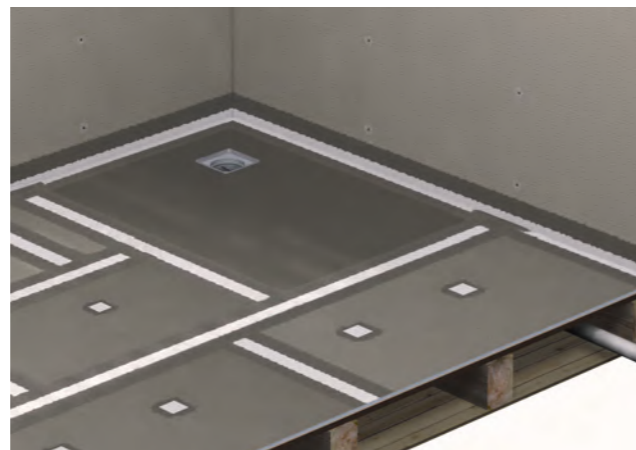

6. Seal all joints and fixings with waterproof joint sealing tape and corners. Your level access wet room is now ready to tile.

## Concrete Floors



1. You will need to cut out the concrete floor to recess the waste and tray where appropriate.

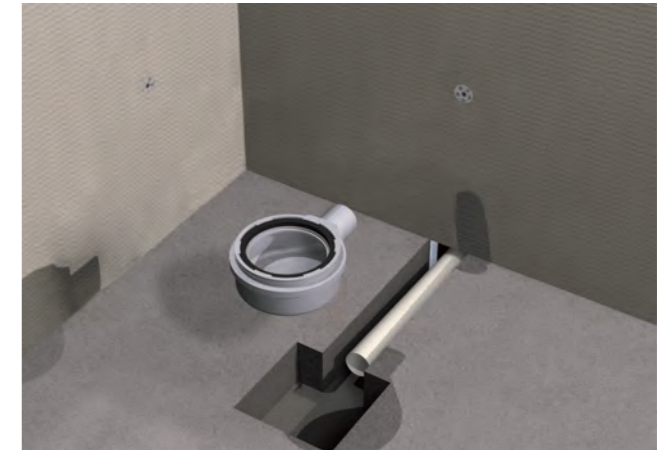

2. Fit the horizontal waste into position within the concrete floor.

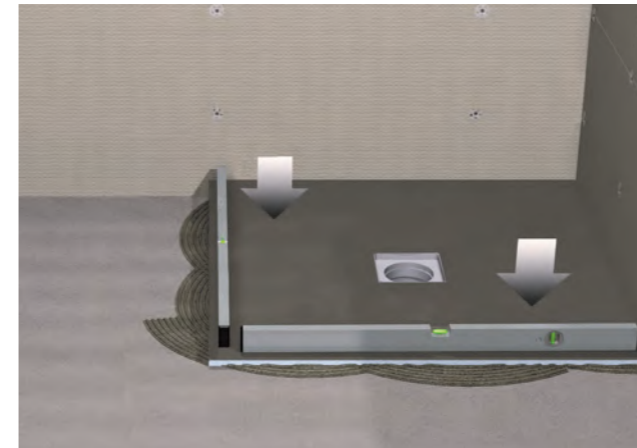

3. Fit the shower tray into position using fixing adhesive.



4. Fit waterproof corners.

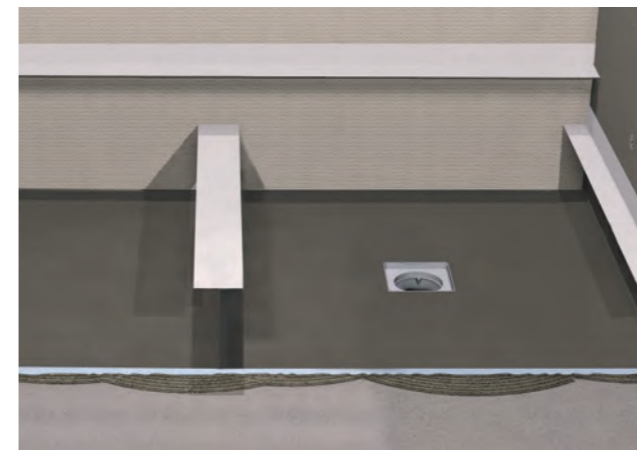

5. Fit floor panels to entire floor area sealing joints with waterproof joint tape.



6. Your level access wet room is now ready to tile.



# Terms & Conditions

## Prices

This price list supersedes all previous publications with goods being invoiced at prices ruling on date of despatch. Prices are subject to alteration without notice and include VAT.

## Delivery

Orders in excess of £500.00 nett invoice value will not be subject to carriage charge and will be delivered within two working days from receipt of order. Orders below £50.00 will be subject to a fixed charge of £5.00. Any claims for non-delivery, shortage or damaged goods must be reported in writing to the company within 14 working days from date of delivery. Such claims will not be accepted for deliveries to a third party delivery address.

## Returned Goods

Requests to return goods must be made in writing to Returns.Department@crosswater.co.uk and include the product details, purchase order number and reason for return. Requests for items not required must be received within 21 days, be in perfect condition, in the original packaging and will be subject to a 12.5% re-stocking charge. Requests for damaged, goods with missing parts and picking errors must be received within 14 days of the delivery date. Faulty items may be returned for testing or inspection at any point but must be provided with proof of purchase. Special orders are non-returnable. Collection will only be made from point of delivery. Damaged will not be collected once they have been sent to a third party

## Retention of Title

Ownership of goods shall remain in the company until full payment has been received for all goods comprised in this contract. If any goods are re-sold before payment is made the Company's right of ownership shall be transferred to the proceeds of sale or to the claim for such proceeds.

## Payment

Payment is to be made by the end of the month following the date of Invoice. Failure to pay may result in the Company declining to accept orders until such time that your account is brought up to date.

## Liability

All quotations are given and goods sold subject to the conditions that the seller's liability is limited to goods proved to have been defective in material or workmanship when goods have not been used for the purpose for which they were intended, not fitted correctly, not maintained to the seller's recommended standards or have been abused or misused.

## Errors & Omissions

In the interest of continuing design, development and product improvement, Crosswater reserve the right to change colour, designs and product specifications without prior notice.

## Lifetime Guarantee\*

Crosswater showering products, unless otherwise stated carry a lifetime guarantee, which covers all manufacturing defects.

- The guarantee is only available to original purchasers who have proof of purchase.
- If the product has been installed, Crosswater must be given the opportunity to inspect the product in the installed condition.
- If the product is defective in materials or manufacture the original purchaser must contact our Technical Department within 30 days of the fault occurring. If the fault is not resolved the goods should be returned to Crosswater and at our discretion we will refund the purchase price, repair and return the goods to you or send new goods or parts to you as a replacement, this shall constitute our sole obligation under this guarantee. Crosswater cannot be held liable for any reinstatement costs or maintenance charges relating to the replacement of spare parts.
- Due to a continuous development program. If in our opinion the product has failed under the terms of the guarantee and a replacement is offered but identical goods are no longer available, Crosswater will replace it with our nearest equivalent product.
- This guarantee covers normal use, it does not cover faults caused by wilful damage, incorrect installation, neglect, misuse, inappropriate cleaning, accidental damage and other events outside Crosswater control.
- The guarantee does not cover any product that has been altered or modified in any way without the prior written consent of Crosswater.
- If a claim is made under the guarantee a site visit maybe required which is chargeable, if the defect is due to faulty materials or manufacturing Crosswater will refund the cost of the site visit.
- The guarantee is only valid for products purchased, installed and used in the United Kingdom.
- The guarantee does not cover ex-display units.
- The benefit of this guarantee cannot be transferred to a third party.
- The guarantee is in addition to and does not affect your statutory rights.
- The product should only be cleaned with warm soapy water. Aggressive cleaning fluids could damage the enclosure and will invalidate the guarantee.



\*All products carry a lifetime guarantee, with the exception of the following:

- Edge bath screen, Supreme Deluxe bath screen and all seals - 12 month guarantee
- Wastes - 10 year guarantee

## 15 Year Guarantee\*

All Crosswater brassware and shower valves, unless otherwise stated, carry a 15 year guarantee which covers all manufacturing defects. This guarantee does not cover damage during fitting, misuse or inappropriate cleaning or consumable goods. Care should be taken in hard-water areas to ensure the cartridge is regularly cleaned.



\*With the exception of cartridges which carry a 5 year guarantee, and hoses, "o" rings, diverters and shower hoses which are all guaranteed for 1 year.

## Product Compatibility

Whilst the majority of Crosswater products are compatible, care should be taken on product selection prior to ordering to avoid installation issues. Technical drawings are available on our website or on request.

## Easy Installation

All products incorporate a clever width adjustment feature offering between 15mm and 60mm width allowance to cope with out of true walls, ensuring that they sit squarely on the shower tray. Most products are reversible for left or right hand fitting.

## Installation Notes

Trays must be plumbed and level, walls should be tiled down to the tray and sealed before doors or frames are fitted. Dimensions are designed for tiled in trays - not unfitted tray sizes. All doors and enclosures must be fitted to a tiled surface, not tiled up to the inside edge of the door. Enclosures must not be completely sealed on the inside, please refer to fitting instructions. Due to the weight of the shower doors you must ensure that the walls to which fixing is to be carried out are of a suitable construction to support the enclosure.

For further advice, please contact Crosswater customer helpline: **0345 873 8840**

Designed and produced by In The White Room  
www.inthewhiteroom.com

# Visit your local bathroom specialist.

## *Expertise & design*

Specialist bathroom retailers can offer expert assistance with room layout design and technical considerations. Many will do this in the comfort of your own home and can provide full 3D design plans so you can visualise and create your own perfect bathroom space.

## *Experience the products*

The purchase process is an emotional one. Specialist showrooms allow you to touch and feel a wide variety of bathroom products in relaxed surroundings whilst gaining inspiration from knowledgeable professionals who will explain the benefits of each product and make recommendations that match your personal preferences.

## *Reassuring aftersales care*

Once your perfect bathroom is installed, local bathroom specialists offer an easy and personal point of contact for any aftersales support you may need, delivering complete peace of mind.



# Need more bathroom inspiration?

*For even more choice, ideas and bathroom inspiration download other Crosswater portfolio brochures at [crosswater.co.uk](http://crosswater.co.uk) or pick one up from your local bathroom specialist.*

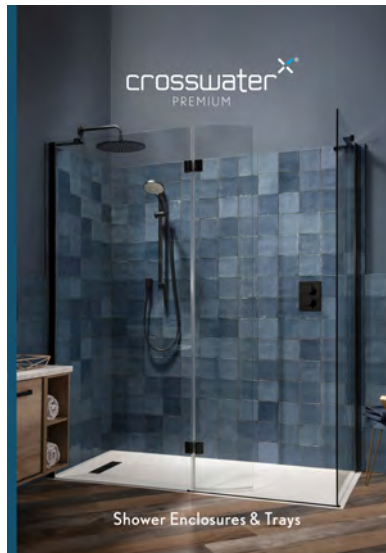

crosswater<sup>®</sup>

Lake View House, Rennie Drive, Dartford, Kent DA1 5FU  
Tel: 0345 873 8840 Email: [sales@crosswater.co.uk](mailto:sales@crosswater.co.uk)

[crosswater.co.uk](http://crosswater.co.uk)



Part of the Bathroom Brands Group

