

ROMAN[®]

REFINED SHOWERING



www.roman-showers.com



At the heart of Roman is the desire to be the best.

It is Roman's vision to lead and innovate in the Showering industry.

To design and manufacture top quality inspirational showering solutions,
which offers choice for all markets.

To expertly manufacture our products in Britain, so they are designed and built to last and offer a lifetime of effortless showering for all. It is our aim to give all our customers exceptional value and service; this ethos runs throughout the culture of the business and cannot be imitated.

“ Great brands always balance
identity, integrity and efficiency. ”
- Matteo Ferrara

Who we are

ROMAN has been designing and manufacturing showering solutions for over 35 years, and is home to the UK's largest shower manufacturing plant. All Roman products are designed and created in Britain, offering the ultimate in quality, precision and craftsmanship. Roman's diverse and versatile collection of products encompasses something for every style and shape bathroom – no matter what the budget.

Highest Quality Materials

Roman only use the finest quality of materials to guarantee unsurpassed quality and certainty in our manufacturing process, ensuring all of our products reach exceptional levels of style and performance. We carefully fabricate and anodise all our aluminium profiles. We use aluminium because it is; light, strong and requires minimal maintenance. The anodising process increases corrosion resistance, product durability and further enhances the material properties. Our specialist anodising offers a bright chrome like finish which is significantly in excess of standard aluminium finishing.

Roman Stone shower trays are manufactured from solid surface and are inherently anti-slip and carry the highest national standard of DIN. Roman's Anti-Slip shower trays combine luxury and durability and add value to the shower tray market.

Glass

All our enclosures feature toughened safety glass. This is a heat treatment to increase the glass strength to make it around 5 times stronger than normal glass. If the glass were to break due to impact, it would shatter into lots of small pieces which are much less dangerous and will help you avoid any cuts or injury. All glass is strictly tested in accordance with EN14428.

Products Designed for All

Innovation and exceptional product design differentiates Roman from the competition. Our products are carefully designed for all. We consider different users' needs to give totally effortless entry to the entire family. Whether you would like door-less entry, level access, handles that can be used with a flat hand, or a wider aperture, we have something that will work with your space all finished with a stylish designer look.

Customer Service

Roman has an in-house customer support network, who are there to offer advice and support for each purchase at every stage; from initial enquiry through to after sales care advice. Roman employs over 20 full time members of staff in our Customer Support Centre and over 40 Technical Service Representatives nationwide who all receive comprehensive training on the manufacture and installation of Roman's collection of products.

Branding

Roman is a reputable and well established UK Brand, now supplying showering products all over the World. Our foundations are strongly rooted in; innovative design, manufacture, quality and customer service. Roman has achieved the leading position in the Market place by consistent and creative product innovation and has produced growth across all UK Market sectors and strong growth in 56 International Markets. Our products are used in some of the finest hotels Worldwide.



Award winning

Product Design & Innovation

Our products and ranges have won multiple awards including The Queens Award for Enterprise - International Trade, in 2017.

We have also been identified as one of London Stock Exchange's 1000 Companies to Inspire Britain. We are extremely proud to be recognised as one of the UK's fastest growing and most dynamic small and medium sized businesses.

Roman is included in the FT1000, which is the list of Europe's Fastest Growing Companies, compiled by the Financial Times. We have also been awarded the Bathroom Safety Compliance Award 2018 by the NHIC.



Trust

Buy with confidence

All Roman products are designed and created in the UK, offering the ultimate in quality, precision and craftsmanship. All Roman's manufacturing processes are carried out at our UK Manufacturing Plant and Headquarters and meet and exceed approved UK and European testing standards.

For complete peace of mind, all Roman Shower Enclosures and Bath Screens are accompanied by a fully service backed **Truelife Lifetime Guarantee**.



Inspiration

Helping you to design your bathroom

Roman products are available on the Virtual Worlds design service. For more information contact Roman Customer Relations 01325 328033

For project applications Roman products are available as a BIM file download from: www.roman-showers/available-downloads.com

Making your product selection easier. Roman products are available on EQ software. For more information contact Customer Relations on 01325 328033.



Protection

All glass pre-coated

All Roman's enclosures and bath screens are pre-coated with Roman Ultra Care, our own unique glass protection system. (For full details see page 148)

All Roman products are designed and manufactured to present easy cleaning ability to ensure your Roman showering experience lasts for many years.



Pricing - VAT is calculated at 20% rate.

Roman have an ongoing policy of design, development and improvement and thus reserve the right to modify specification, ranges and prices without prior notice. Images are for illustration purposes only - please refer to your retailer as site conditions will vary or contact Roman Customer Relations on 01325 328033 for installation specifications.

Door Styles

Quadrant

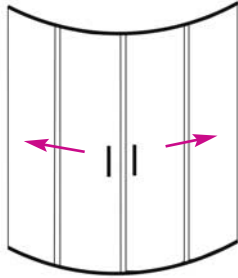

The Quadrant shaped enclosure will sit beautifully in the corner of your bathroom, making it an ideal solution for the smaller bathroom. It incorporates unobtrusive sliding doors.

Sliding Door

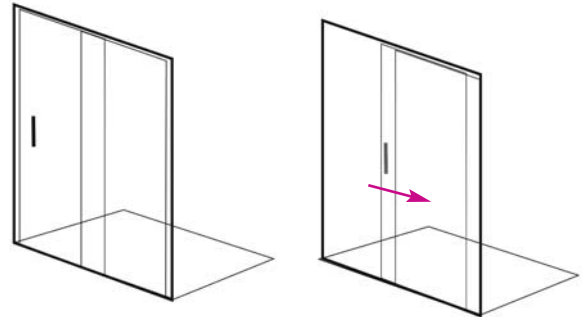

The sliding door action offers wide and easy access, with no protrusion into the bathroom or showering area.

Neo-Angle

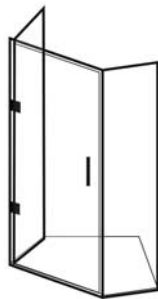

This flexible design allows for inward or outward opening door entry. It presents a unique footprint, to work around existing fixtures and fittings.

Bi-Fold Door

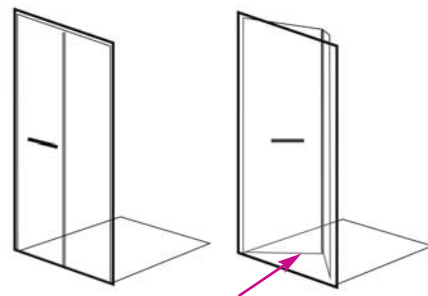

Inward opening door presents a flexible space saving solution. Avoids existing fixtures and fittings in the bathroom area.

Pivot and In-Swing Doors

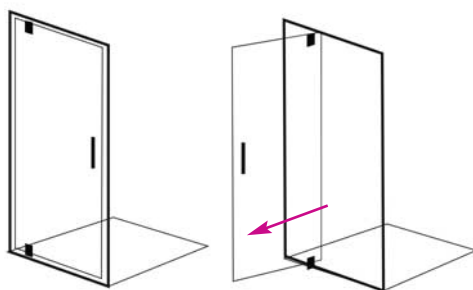

Outward opening door, takes up minimal external space due to the positioning of the hinge point, meaning it protrudes less into the bathroom space.

Hinged Door

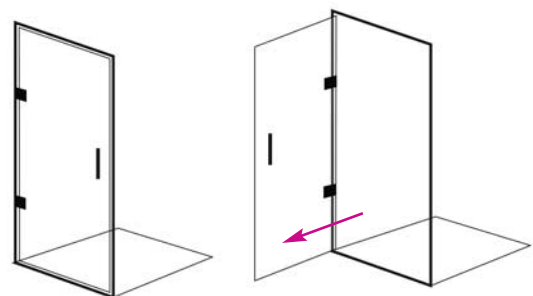

Smooth outward opening door, featuring soft self-close hinges for a superior finish.

For Wetroom Panel styles see pages 94 - 119

Contents

Decem

10mm Sheer Luxury

Pages 8 - 35

Liberty

8mm & 10mm Frameless Hinged and Sliding

Pages 36 - 53

Innov8

8mm Frameless Pivoting and Bi-Fold

Pages 54 - 63

Lumin8

8mm Semi-Frameless

Pages 64 - 79

Embrace

6mm & 8mm Semi-Frameless

Pages 80 - 89

Collage

4mm & 6mm Framed

Pages 90 - 93

Wetrooms

including Select Panels

8mm and 10mm Glass Options

Pages 94 - 119

Shower Trays

Pages 120 - 129

Bath Screens

Pages 130 - 143

Accessories and Product After Care

Pages 144 - 149

Bespoke Service

Page 150

Guarantee Information

Pages 151

10mm Decem

- Sliding Door Enclosures
- Hinged Door Enclosures
- Neo-Angle Enclosures
- Walk-in Enclosures
- Victoriana Glass Design
- Wetroom Panels
- Hinged Bath Screen

Latin for 10, the Decem 10mm thick glass range is the ultimate in showering design.

The Decem range has been meticulously designed and engineered by our Roman Design experts.

Components of the highest quality have been brought together. With 10mm thick toughened glass. Chromed brass hardware with self-closing hinges that offer a superior action and create a positive seal for the door. Made from chromed brass components to give a quality finish and long lasting performance.

Our unique Water Safe System has been engineered to offer the maximum water integrity available for a minimalist designed enclosure. The system will guide the water back into your showering area, to enhance performance.

“ There are three responses to a piece of design – yes, no and Wow!
Wow is the one to aim for. ”

- Milton Glaser



Sliding Door



1200 Alcove Fitting

- Left hand Door DXT12AL
- Grey Shimmer Infinity Shower Tray IAG129G

“Create a luxury showering space with this stunningly visual and superior sliding door function.”



1700 x 800 Corner Fitting

- Left hand Door DXT17L and Side Panel DX2R8
- Shower Tray RLT178
- Shower Basket RSB01



Left Hand



Right Hand

GLASS THICKNESS
10
Millimetres

TOTAL HEIGHT
2020
Millimetres

GLASS PROTECTION
ULTRA CARE
BY ROMAN

TRUELIFE
LIFETIME
GUARANTEE

Features and Benefits:

- Wall profile height 2000mm
- Height to top of door glass 2020mm
- Silent and ultra-smooth running roller bearing system
- Luxury 'soft close' door system
- Chromed brass machined components
- Chromed brass feature handle
- Low profile PVC seals
- Bright silver frame
- 15mm of adjustment in each profile
- Roman Water Safe System to tray or floor
- Please indicate handing (RH or LH) when ordering
- Available with square hardware



Square Hardware



Corner Fitting

Enclosure Size (mm)	Handing	Adjustment (mm)	Door Aperture (mm)	Door Code	Side Panel Code	Total Cost ex VAT	Total Cost inc VAT
1200 x 800	Left Hand	1165 - 1180 & 765 - 780	418	DXT12L	DX2R8	£1794.52	£2153.42
1200 x 800	Right Hand	1165 - 1180 & 765 - 780	418	DXT12R	DX2R8	£1794.52	£2153.42
1200 x 900	Left Hand	1165 - 1180 & 865 - 880	418	DXT12L	DX2R9	£1845.79	£2214.95
1200 x 900	Right Hand	1165 - 1180 & 865 - 880	418	DXT12R	DX2R9	£1845.79	£2214.95
1400 x 800	Left Hand	1365 - 1380 & 765 - 780	518	DXT14L	DX2R8	£1897.06	£2276.47
1400 x 800	Right Hand	1365 - 1380 & 765 - 780	518	DXT14R	DX2R8	£1897.06	£2276.47
1400 x 900	Left Hand	1365 - 1380 & 865 - 880	518	DXT14L	DX2R9	£1948.33	£2338.00
1400 x 900	Right Hand	1365 - 1380 & 865 - 880	518	DXT14R	DX2R9	£1948.33	£2338.00
1700 x 800	Left Hand	1665 - 1680 & 765 - 780	668	DXT17L	DX2R8	£2050.88	£2461.06
1700 x 800	Right Hand	1665 - 1680 & 765 - 780	668	DXT17R	DX2R8	£2050.88	£2461.06

Alcove Fitting

Enclosure Size (mm)	Handing	Adjustment (mm)	Door Aperture (mm)	Door Code	Total Cost ex VAT	Total Cost inc VAT
1200	Left Hand	1165 - 1190	430	DXT12AL	£1281.80	£1538.16
1200	Right Hand	1165 - 1190	430	DXT12AR	£1281.80	£1538.16
1400	Left Hand	1365 - 1390	530	DXT14AL	£1384.34	£1661.21
1400	Right Hand	1365 - 1390	530	DXT14AR	£1384.34	£1661.21
1700	Left Hand	1665 - 1690	680	DXT17AL	£1538.16	£1845.79
1700	Right Hand	1665 - 1690	680	DXT17AR	£1538.16	£1845.79

Left or Right Handed must be specified

Compatible Trays:	Page
Roman Anti-Slip Trays	122 - 123
Roman Infinity Trays	124 - 125
Roman Low Level Trays	128 - 129
Roman Shield System	147

Decem

Sliding Door

with finger pull handle



1700 x 800 Corner fitting

- Left hand door DXT17FL and Side Panel DX2R8
- Roman Low Level Tray RLT178
- Shower Basket RSB01

“Luxury cushioned close door operation.”

GLASS THICKNESS
10
Millimetres

TOTAL HEIGHT
2020
Millimetres

GLASS PROTECTION
ULTRA CARE
BY ROMAN

TRUELIFE
LIFETIME GUARANTEE

Features and Benefits:

- Wall profile height 2000mm
- Height to top of door glass 2020mm
- Silent and ultra-smooth running roller bearing system
- Luxury 'soft close' door system
- Chromed brass machined components
- Chromed brass finger pull handle
- Low profile PVC seals
- Bright silver frame
- 15mm of adjustment in each profile
- Roman Water Safe System to tray or floor
- Alcove and corner options
- Please indicate handing (RH or LH) when ordering

Both handle options supplied as standard



Finger Pull

Easy Grip

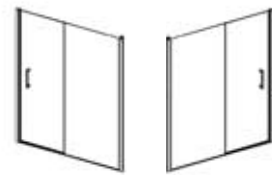

Left Hand

Right Hand

1700 Alcove Fitting

- Left hand door DXT17AFL
- Roman Low Level Tray RLT178
- Shower Basket RSB05

Corner Fitting

Enclosure Size (mm)	Handing	Adjustment (mm)	Door Aperture (mm)	Door Code	Side Panel Code	Total Cost ex VAT	Total Cost inc VAT
1200 x 800	Left Hand	1165 - 1180 & 765 - 780	418	DXT12FL	DX2R8	£1794.52	£2153.42
1200 x 800	Right Hand	1165 - 1180 & 765 - 780	418	DXT12FR	DX2R8	£1794.52	£2153.42
1200 x 900	Left Hand	1165 - 1180 & 865 - 880	418	DXT12FL	DX2R9	£1845.79	£2214.95
1200 x 900	Right Hand	1165 - 1180 & 865 - 880	418	DXT12FR	DX2R9	£1845.79	£2214.95
1400 x 800	Left Hand	1365 - 1380 & 765 - 780	518	DXT14FL	DX2R8	£1897.06	£2276.47
1400 x 800	Right Hand	1365 - 1380 & 765 - 780	518	DXT14FR	DX2R8	£1897.06	£2276.47
1400 x 900	Left Hand	1365 - 1380 & 865 - 880	518	DXT14FL	DX2R9	£1948.33	£2338.00
1400 x 900	Right Hand	1365 - 1380 & 865 - 880	518	DXT14FR	DX2R9	£1948.33	£2338.00
1700 x 800	Left Hand	1665 - 1680 & 765 - 780	668	DXT17FL	DX2R8	£2050.88	£2461.06
1700 x 800	Right Hand	1665 - 1680 & 765 - 780	668	DXT17FR	DX2R8	£2050.88	£2461.06

Alcove Fitting

Enclosure Size (mm)	Handing	Adjustment (mm)	Door Aperture (mm)	Door Code	Total Cost ex VAT	Total Cost inc VAT
1200	Left Hand	1165 - 1190	430	DXT12AFL	£1281.80	£1538.16
1200	Right Hand	1165 - 1190	430	DXT12AFR	£1281.80	£1538.16
1400	Left Hand	1365 - 1390	530	DXT14AFL	£1384.34	£1661.21
1400	Right Hand	1365 - 1390	530	DXT14AFR	£1384.34	£1661.21
1700	Left Hand	1665 - 1690	680	DXT17AFL	£1538.16	£1845.79
1700	Right Hand	1665 - 1690	680	DXT17AFR	£1538.16	£1845.79

Compatible Trays:	Page
Roman Anti-Slip Trays	122 - 123
Roman Infinity Trays	124 - 125
Roman Low Level Trays	128 - 129
Roman Shield System	147

Left or Right Handed must be specified

Level Access Sliding Door

with finger pull handle



1200 Alcove Fitting

- Left hand Door with Finger Pull handle option DXTLE12AFL
- 1200 x 900 Black Shimmer Infinity Tray IAG129B

“Install with a Roman Anti-Slip Shower Tray
for a totally inclusive showering solution”



1700 x 800 Corner Fitting

- Left Hand Door with Easy Grip Handle DXTLE17CFL and Side Panel DX2R8
- 1700 x 800 Gloss White Infinity Tray IAG178

GLASS THICKNESS
10
Millimetres

TOTAL HEIGHT
2020
Millimetres

GLASS PROTECTION
ULTRA CARE
BY ROMAN

TRUELIFE
LIFETIME
GUARANTEE

Features and Benefits:

- Wall profile height 2000mm
- Height to top of door glass 2020mm
- Quick release door function for easy cleaning
- 15mm of adjustment in each wall profile
- Optional aluminium water guard
- Barrier free entry option
- Silent and ultra-smooth running roller bearing system
- Luxury 'soft close' door system
- Chromed brass machined components
- Chromed brass finger pull handle
- Low profile PVC seals
- Bright silver frame
- Alcove and corner options
- Please indicate handing (RH or LH) when ordering

Both handle options supplied as standard



Finger Pull



Easy Grip

Corner Fitting

Enclosure Size (mm)	Handing	Adjustment (mm)	Door Aperture (mm)	Door Code	Side Panel Code	Total Cost ex VAT	Total Cost inc VAT
1200 x 800	Left Hand	1165 - 1180 & 765 - 780	418	DXTLE12CFL	DX2R8	£1857.48	£2228.98
1200 x 800	Right Hand	1165 - 1180 & 765 - 780	418	DXTLE12CFR	DX2R8	£1857.48	£2228.98
1200 x 900	Left Hand	1165 - 1180 & 865 - 880	418	DXTLE12CFL	DX2R9	£1908.75	£2290.50
1200 x 900	Right Hand	1165 - 1180 & 865 - 880	418	DXTLE12CFR	DX2R9	£1908.75	£2290.50
1400 x 800	Left Hand	1365 - 1380 & 765 - 780	518	DXTLE14CFL	DX2R8	£1960.02	£2352.02
1400 x 800	Right Hand	1365 - 1380 & 765 - 780	518	DXTLE14CFR	DX2R8	£1960.02	£2352.02
1400 x 900	Left Hand	1365 - 1380 & 865 - 880	518	DXTLE14CFL	DX2R9	£2011.29	£2413.55
1400 x 900	Right Hand	1365 - 1380 & 865 - 880	518	DXTLE14CFR	DX2R9	£2011.29	£2413.55
1700 x 800	Left Hand	1665 - 1680 & 765 - 780	668	DXTLE17CFL	DX2R8	£2113.83	£2536.60
1700 x 800	Right Hand	1665 - 1680 & 765 - 780	668	DXTLE17CFR	DX2R8	£2113.83	£2536.60

Alcove Fitting

Enclosure Size (mm)	Handing	Adjustment (mm)	Door Aperture (mm)	Door Code	Total Cost ex VAT	Total Cost inc VAT
1200	Left Hand	1160 - 1190	430	DXTLE12AFL	£1344.76	£1613.71
1200	Right Hand	1160 - 1190	430	DXTLE12AFR	£1344.76	£1613.71
1400	Left Hand	1360 - 1390	530	DXTLE14AFL	£1447.30	£1736.76
1400	Right Hand	1360 - 1390	530	DXTLE14AFR	£1447.30	£1736.76
1700	Left Hand	1660 - 1690	680	DXTLE17AFL	£1601.11	£1921.33
1700	Right Hand	1660 - 1690	680	DXTLE17AFR	£1601.11	£1921.33

Left or Right Handed must be specified

Compatible Trays:	Page
Roman Anti-Slip Trays	122 - 123
Roman Infinity Trays	124 - 125
Roman Low Level Trays	128 - 129
Roman Shield System	147

Hinged Door

Outward Opening



900 x 900 Corner Fitting

- Door DXL9CA
- Side Panel DXR9
- Roman Low Level Tray RLT9
- Shower Basket RSB07

“Integrated Water Safe System for unparalleled water integrity.”



900 Alcove Fitting

- Door DXL9B
- Roman Low Level Tray RLT79
- Shower Basket RSB07

GLASS THICKNESS
10
Millimetres

TOTAL HEIGHT
2000
Millimetres

REVERSIBLE

GLASS PROTECTION
ULTRA CARE
BY ROMAN

TRUETIME
LIFETIME
GUARANTEE

Features and Benefits:

- Self-closing hinges
- Choice of curved or square chromed brass handle and hinges
- Bracing bar for optional usage supplied as standard with corner option
- Integrated 'tray or floor' Water Safe System
- Suitable for installation onto tray or wetroom floor
- 15mm of adjustment in each minimal wall profile for easy installation
- All door and panel sizes are interchangeable to create the enclosure size of your choice



Please add **A** for Curved Hardware or add **B** for Square hardware to the door code when ordering

Corner Fitting

Size (mm)	Description	Adjustment (mm)	Aperture (mm)	Code	Total Cost ex VAT	Total Cost inc VAT
760	Door	725 - 740	630	DXL76C	£662.18	£794.62
800	Door	765 - 780	670	DXL8C	£672.94	£807.53
900	Door	865 - 880	770	DXL9C	£683.70	£820.44
1000	Door	965 - 980	870	DXL10C	£694.48	£833.38
760	Side Panel	725 - 740	-	DXR76	£662.18	£794.62
800	Side Panel	765 - 780	-	DXR8	£672.94	£807.53
900	Side Panel	865 - 880	-	DXR9	£683.70	£820.44
1000	Side Panel	965 - 980	-	DXR10	£694.48	£833.38

Alcove Fitting

Door Size (mm)	Adjustment (mm)	Aperture (mm)	Door Code	Total Cost ex VAT	Total Cost inc VAT
760	720 - 750	710	DXL76	£1055.18	£1266.22
800	760 - 790	750	DXL8	£1065.94	£1279.13
900	860 - 890	850	DXL9	£1076.71	£1292.05
1000	960 - 990	950	DXL10	£1087.48	£1304.98

Compatible Trays:	Page
Roman Anti-Slip Trays	122 - 123
Roman Infinity Trays	124 - 125
Roman Low Level Trays	128 - 129
Roman Shield System	147

Decem

Hinged Door

with one in-line panel

Outward Opening



1200 Alcove Fitting

- Door DXL1HDB
- In-Line Panel DXL1H12
- Roman Low Level Tray RLT129
- Shower Basket RSB07

“Frameless and minimalist design”

GLASS THICKNESS
10
Millimetres

TOTAL HEIGHT
2030
Millimetres

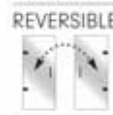

Features and Benefits:

- Glass height 2000mm
- Total height with brace bar 2030mm
- Self-closing hinges
- Decem bracing bar for optional usage supplied as standard
- Integrated 'tray or floor' Water Safe System
- Suitable for installation onto tray or wetroom floor
- 15mm of adjustment in each minimal wall profile for easy installation
- Door aperture 630mm
- Additional optional panel bracing is available



Please add **A** for Curved Hardware or add **B** for Square hardware to the door code when ordering



900 x 1200 Corner Fitting

- Door DXL1HDRA
- Side Panel DXHR9
- In-Line Panel DXL1HR12
- Roman Low Level Tray RLT129
- Shower Basket RSB07

Please note: Door aperture/projection is 630mm approx. - enclosure size required is achieved by size of In-Line and Side Panels (this is reflected in Order Codes).

Corner Fitting

Door aperture 630mm

Enclosure Size (mm)	Adjustment (mm)	Door Code	In-Line Panel Code	Side Panel Code	Total Cost ex VAT	Total Cost inc VAT
1000 x 800	965 - 980 & 765 - 780	DXL1HDR	DXL1HR10	DXHR8	£1561.22	£1873.46
1000 x 900	965 - 980 & 865 - 880	DXL1HDR	DXL1HR10	DXHR9	£1615.06	£1938.07
1200 x 800	1165 - 1180 & 765 - 780	DXL1HDR	DXL1HR12	DXHR8	£1722.73	£2067.28
1200 x 900	1165 - 1180 & 865 - 880	DXL1HDR	DXL1HR12	DXHR9	£1776.57	£2131.88
1400 x 800	1365 - 1380 & 765 - 780	DXL1HDR	DXL1HR14	DXHR8	£1776.57	£2131.88
1400 x 900	1365 - 1380 & 865 - 880	DXL1HDR	DXL1HR14	DXHR9	£1830.42	£2196.50
1500 x 800	1465 - 1480 & 765 - 780	DXL1HDR	DXL1HR15	DXHR8	£1857.03	£2228.44
1500 x 900	1465 - 1480 & 865 - 880	DXL1HDR	DXL1HR15	DXHR9	£1910.87	£2293.04
1600 x 800	1565 - 1580 & 765 - 780	DXL1HDR	DXL1HR16	DXHR8	£1938.08	£2325.70
1600 x 900	1565 - 1580 & 865 - 880	DXL1HDR	DXL1HR16	DXHR9	£1991.92	£2390.30
1700 x 800	1665 - 1580 & 765 - 780	DXL1HDR	DXL1HR17	DXHR8	£2018.43	£2422.12
1700 x 900	1665 - 1580 & 865 - 880	DXL1HDR	DXL1HR17	DXHR9	£2072.27	£2486.72

Alcove Fitting

Door aperture 630mm

Enclosure Size (mm)	Adjustment (mm)	Door Code	In-Line Panel Code	Total Cost ex VAT	Total Cost inc VAT
1000	960 - 990	DXL1HD	DXL1H10	£1184.38	£1421.26
1200	1160 - 1190	DXL1HD	DXL1H12	£1292.06	£1550.47
1400	1360 - 1390	DXL1HD	DXL1H14	£1399.73	£1679.68
1500	1460 - 1490	DXL1HD	DXL1H15	£1453.03	£1743.64
1600	1560 - 1590	DXL1HD	DXL1H16	£1507.40	£1808.88
1700	1660 - 1690	DXL1HD	DXL1H17	£1560.63	£1872.76

Compatible Trays:	Page
Roman Anti-Slip Trays	122 - 123
Roman Infinity Trays	124 - 125
Roman Low Level Trays	128 - 129
Roman Shield System	147

Hinged Door

with in-line panel and finger pull handle

Inward Opening



1500 x 800 Alcove Fitting

- Door DXL1HD2FB
- In-Line Panel DXL1H15
- Roman Low Level Tray RLT158
- Shower Basket RSB02

“ For when you prefer an inward opening door ”



1500 x 800 Corner Fitting

- Door DXL1HDR2FB
- Side Panel DXHR8
- In-Line Panel DXL1HR15
- Roman Low Level Tray RLT158
- Shower Basket RSB02

GLASS THICKNESS
10
Millimetres

TOTAL HEIGHT
2030
Millimetres

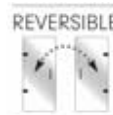

Features and Benefits:

- Glass height 2000mm
- Total height with brace bar 2030mm
- Self-closing hinges
- Square chromed brass hinges
- Finger pull handle
- Decem bracing bar for optional usage supplied as standard
- Integrated 'tray or floor' Water Safe
- 15mm of adjustment in each minimal wall profile for easy installation
- Door aperture 615mm or 515mm (check table below)
- Additional optional panel bracing is available - see pages 100 - 101

Both handle options supplied as standard



Finger Pull



Easy Grip

Please note: Enclosure size required is achieved by size of In-Line and Side Panels (this is reflected in Order Codes).

Corner Fitting

Enclosure Size (mm)	Adjustment (mm)	Door Aperture (mm)	Door Code	In-Line Panel Code	Side Panel Code	Total Cost ex VAT	Total Cost inc VAT
1200 x 800	1165 - 1180 & 765 - 780	515	DXL1HDRFB	DXL1HR212	DXHR8	£1722.73	£2067.28
1200 x 900	1165 - 1180 & 865 - 880	515	DXL1HDRFB	DXL1HR212	DXHR9	£1776.57	£2131.88
1400 x 800	1365 - 1380 & 765 - 780	615	DXL1HDR2FB	DXL1HR14	DXHR8	£1776.57	£2131.88
1400 x 900	1365 - 1380 & 865 - 880	615	DXL1HDR2FB	DXL1HR14	DXHR9	£1830.42	£2196.50
1500 x 800	1465 - 1480 & 765 - 780	615	DXL1HDR2FB	DXL1HR15	DXHR8	£1857.03	£2228.44
1500 x 900	1465 - 1480 & 865 - 880	615	DXL1HDR2FB	DXL1HR15	DXHR9	£1910.87	£2293.04
1600 x 800	1565 - 1580 & 765 - 780	615	DXL1HDR2FB	DXL1HR16	DXHR8	£1938.08	£2325.70
1600 x 900	1565 - 1580 & 865 - 880	615	DXL1HDR2FB	DXL1HR16	DXHR9	£1991.92	£2390.30
1700 x 800	1665 - 1680 & 765 - 780	615	DXL1HDR2FB	DXL1HR17	DXHR8	£2018.43	£2422.12
1700 x 900	1665 - 1680 & 865 - 880	615	DXL1HDR2FB	DXL1HR17	DXHR9	£2072.27	£2486.72

Alcove Fitting

Enclosure Size (mm)	Adjustment (mm)	Door Aperture (mm)	Door Code	In-Line Panel Code	Total Cost ex VAT	Total Cost inc VAT
1200	1160 - 1190	515	DXL1HDFB	DXL1H212	£1292.06	£1550.47
1400	1360 - 1390	615	DXL1HD2FB	DXL1H14	£1399.73	£1679.68
1500	1460 - 1490	615	DXL1HD2FB	DXL1H15	£1453.03	£1743.64
1600	1560 - 1590	615	DXL1HD2FB	DXL1H16	£1507.40	£1808.88
1700	1660 - 1690	615	DXL1HD2FB	DXL1H17	£1560.63	£1872.76

Compatible Trays:	Page
Roman Anti-Slip Trays	122 - 123
Roman Infinity Trays	124 - 125
Roman Low Level Trays	128 - 129
Roman Shield System	147

Decem

Hinged Door

with two in-line panels

Outward Opening



1200 x 800 Corner Fitting

- Hinged Door DXLHDRA
- In-Line Panel DXLHR12
- Side Panel DXHR8
- Roman Low Level Tray RLT128
- Shower Basket RSB01

“ Create your individual bathroom space
with a choice of hardware available ”



1200 Alcove Fitting

- Door DXLHDB
- In-Line Panel DXLH12
- Roman Low Level RLT129
- Shower Basket RSB02

GLASS THICKNESS
10
Millimetres

TOTAL HEIGHT
2030
Millimetres

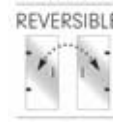

GLASS PROTECTION
ULTRA CARE
BY ROMAN

TRUELIFE
LIFETIME
GUARANTEE

Features and Benefits:

- Glass height 2000mm
- Total height with brace bar 2030mm
- Self-closing hinges
- Choice of curved or square chromed brass handle and hinges
- Decem bracing bar for optional usage supplied as standard
- Integrated 'tray or floor' Water Safe System
- Suitable for installation onto tray or wetroom floor
- 15mm of adjustment in each minimal wall profile for easy installation
- Door aperture 650mm



Curved Hardware - A



Square Hardware - B

Please add **A** for Curved Hardware or add **B** for Square hardware to the door code when ordering

Corner Fitting

Door aperture 650mm

Enclosure Size (mm)	Adjustment (mm)	Door Code	In-Line Panel Code	Side Panel Code	Total Cost ex VAT	Total Cost inc VAT
1200 x 800	1165 - 1180 & 765 - 780	DXLHDR	DXLHR12	DXHR8	£1797.51	£2157.01
1200 x 900	1165 - 1180 & 865 - 880	DXLHDR	DXLHR12	DXHR9	£1851.35	£2221.62
1400 x 800	1365 - 1380 & 765 - 780	DXLHDR	DXLHR14	DXHR8	£1854.87	£2225.84
1400 x 900	1365 - 1380 & 865 - 880	DXLHDR	DXLHR14	DXHR9	£1908.71	£2290.45
1500 x 800	1465 - 1480 & 765 - 780	DXLHDR	DXLHR15	DXHR8	£1944.97	£2333.96
1500 x 900	1465 - 1480 & 865 - 880	DXLHDR	DXLHR15	DXHR9	£1998.81	£2398.57
1600 x 800	1565 - 1580 & 765 - 780	DXLHDR	DXLHR16	DXHR8	£2026.89	£2432.27
1600 x 900	1565 - 1580 & 865 - 880	DXLHDR	DXLHR16	DXHR9	£2080.73	£2496.88

Please note: Door aperture/projection is 650mm approx - enclosure size required is achieved by size of In-Line and Side Panels (this is reflected in Order Codes). In-Line Panels are in packs of two so one order code required only.

Alcove Fitting

Door aperture 650mm

Enclosure Size (mm)	Adjustment (mm)	Door Code	In-Line Panel Code	Total Cost ex VAT	Total Cost inc VAT
1200	1160 - 1190	DXLHD	DXLH12	£1376.18	£1651.42
1400	1360 - 1390	DXLHD	DXLH14	£1490.86	£1789.05
1500	1460 - 1490	DXLHD	DXLH15	£1550.93	£1861.12
1600	1560 - 1590	DXLHD	DXLH16	£1605.55	£1926.66

Please note: In-Line Panels are in packs of two so one order code required only.

Compatible Trays:	Page
Roman Anti-Slip Trays	122 - 123
Roman Infinity Trays	124 - 125
Roman Low Level Trays	128 - 129
Roman Shield System	147

Decem

Hinged Door

with hinged in-line panel

Outward Opening



1200 x 900 Corner Fitting

- Hinged Door DXL2HDRA
- In-Line Panel DXL2HR12
- Side Panel DX1R9
- Roman Shield Wetroom System
- Shower Basket RSB01

“With luxury 10mm thick glass this stunning enclosure will create a luxury showering experience”



1200 Alcove Fitting

- Hinged Door DXL2HDB
- In-Line Panel DXL2H12
- Roman Low Level Tray RLT128



Features and Benefits:

- Glass height 2000mm
- Total height with brace bar 2030mm
- Self-closing hinges
- Choice of curved or square chromed brass handle and hinges
- Decem bracing bar for optional usage supplied as standard
- Integrated 'tray or floor' Water Safe System
- Suitable for installation onto tray or wetroom floor
- 15mm of adjustment in each minimal wall profile for easy installation
- Door aperture: 670mm corner fitting, 650mm alcove fitting



Please add **A** for Curved Hardware or add **B** for Square hardware to the door code when ordering

Corner Fitting

Enclosure Size (mm)	Adjustment (mm)	Door Code	In-Line Panel Code	Side Panel Code	Total Cost ex VAT	Total Cost inc VAT
1000 x 760	965 - 980 & 725 - 740	DXL2HDR	DXL2HR10	DX1R76	£1572.24	£1886.69
1000 x 800	965 - 980 & 765 - 780	DXL2HDR	DXL2HR10	DX1R8	£1626.09	£1951.31
1000 x 900	965 - 980 & 865 - 880	DXL2HDR	DXL2HR10	DX1R9	£1679.91	£2015.89
1000 x 1000	965 - 980 & 965 - 980	DXL2HDR	DXL2HR10	DX1R10	£1787.60	£2145.12
1200 x 760	1165 - 1180 & 725 - 740	DXL2HDR	DXL2HR12	DX1R76	£1744.27	£2093.12
1200 x 800	1165 - 1180 & 765 - 780	DXL2HDR	DXL2HR12	DX1R8	£1798.12	£2157.74
1200 x 900	1165 - 1180 & 865 - 880	DXL2HDR	DXL2HR12	DX1R9	£1851.94	£2222.33
1200 x 1000	1165 - 1180 & 965 - 980	DXL2HDR	DXL2HR12	DX1R10	£1959.63	£2351.56

Alcove Fitting

Enclosure Size (mm)	Adjustment (mm)	Door Code	In-Line Panel Code	Total Cost ex VAT	Total Cost inc VAT
1000	960 - 990	DXL2HD	DXL2H10	£1261.50	£1513.80
1200	1160 - 1190	DXL2HD	DXL2H12	£1376.18	£1651.42

Compatible Trays:	Page
Roman Anti-Slip Trays	122 - 123
Roman Infinity Trays	124 - 125
Roman Low Level Trays	128 - 129
Roman Shield System	147

Decem

Neo Angle

enclosure

Outward Opening



1200 x 900 Neo Angle

- Neo-Angle Door DXPD8
- Neo-Angle Panels DXP129PAL
- Neo-Angle Shower Tray DNT129L
- Shower Basket RSB01

“ Ingenious angled design fits around existing fixtures and fittings ”



GLASS THICKNESS
10
Millimetres

TOTAL HEIGHT
2008
Millimetres

GLASS PROTECTION
ULTRA CARE
BY ROMAN

TRUELIFE
LIFETIME GUARANTEE

Features and Benefits:

- Wall profile height 2000mm
- Total height to top of bracing 2008mm
- Chromed brass machined components
- Chromed brass self-closing hinges and feature handle
- Low profile PVC seals
- Bright silver frame
- 15mm of adjustment in each profile
- Integrated 'tray or floor' Water Safe System
- Please indicate handing (RH or LH) when ordering
- Door always hinges from the short panel
- Suitable for installation to Neo tray or straight to floor

900 x 900 Neo Angle

- Neo-Angle Door DXPDB
- Neo-Angle Panels DXPPAL
- Neo-Angle Shower Tray DNT9
- Shower Basket RSB02



Left Hand

Right Hand



Please note: Door aperture/projection is 660mm - enclosure size required is achieved by size of Neo Panels (this is reflected in Order Codes).

Corner Fitting

Enclosure Size (mm)	Handing	Adjustment (mm)	Door Code	Neo-Panels Code	Total Cost ex VAT	Total Cost inc VAT
900 x 900	Left Hand	860 - 875	DXPDB	DXPPAL	£1384.34	£1661.21
900 x 900	Right Hand	860 - 875	DXPDB	DXPPAR	£1384.34	£1661.21
1200 x 900	Left Hand	1160 - 1175 & 860 - 875	DXPDB	DXP129PAL	£1538.15	£1845.78
1200 x 900	Right Hand	1160 - 1175 & 860 - 875	DXPDB	DXP129PAR	£1538.15	£1845.78

Neo-Angle Trays:

See page 126 for full details and pricing

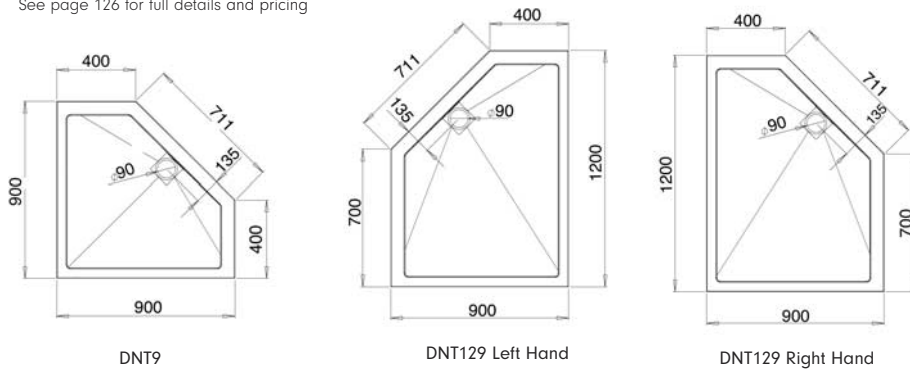

DNT9

DNT129 Left Hand

DNT129 Right Hand

Decem





Victoriana

glass design

900 x 900 Hinged Door for Corner fitting (left hand)

- Hinged Door and Side Panel VXL9CB and VXR9
- Roman Shower Tray RLT9

“Elegance comes from being as beautiful inside as outside.”

- Coco Chanel

Available on selected products
See pages 30 - 31 for full details

Decem

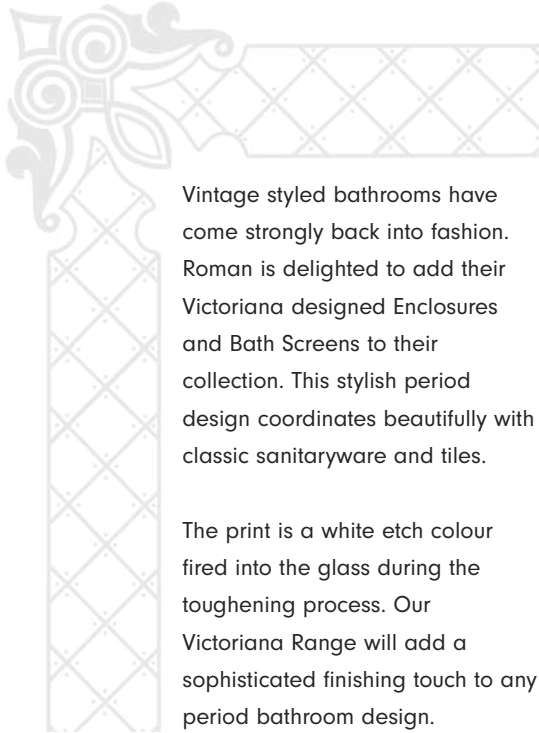

Vintage styled bathrooms have come strongly back into fashion. Roman is delighted to add their Victoriana designed Enclosures and Bath Screens to their collection. This stylish period design coordinates beautifully with classic sanitaryware and tiles.

The print is a white etch colour fired into the glass during the toughening process. Our Victoriana Range will add a sophisticated finishing touch to any period bathroom design.



• Wetroom Panel VXFCP12

Victoriana



Hinged Door for Corner Fitting



Hinged Door for Alcove fitting



Neo Angle Enclosure



Hinged Door with In-Line Panel for Corner



Hinged Door with In-Line Panel for alcove



Wetroom Panel



Square Hardware - B



Curved Hardware - A

Please add A for Curved Hardware or add B for Square hardware to the door code when ordering

Please add **A** for Curved Hardware or add **B** for Square hardware to the door code when ordering and Left or right handing must be specified e.g. **VXL9CB Right Hand**

Hinged Door for corner fitting - see pages 16 - 17 for full product details

Enclosure Size (mm)	Adjustment (mm)	Door Code	Side Panel Code	Total Cost ex VAT	Total Cost inc VAT
900 x 900	865 - 880	VXL9C	VXR9	£1504.16	£1804.99

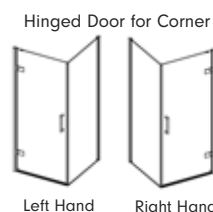

Hinged Door for alcove fitting - see pages 16 - 17 for full product details

Enclosure Size (mm)	Adjustment (mm)	Door Code	Total Cost ex VAT	Total Cost inc VAT
900	860 - 890	VXL9	£1184.38	£1421.26



Hinged Door with In-Line Panel for alcove - see pages 18 - 19 for full product details

Enclosure Size (mm)	Adjustment (mm)	Door Code	In-Line Panel Code	Total Cost ex VAT	Total Cost inc VAT
1000*	960 - 990	VXL1HD	VXL1H10	£1248.98	£1498.78
1200*	1160 - 1190	VXL1HD	VXL1H12	£1356.66	£1627.99
1400	1360 - 1390	VXL1HD	VXL1H14	£1539.70	£1847.64
1600	1560 - 1590	VXL1HD	VXL1H16	£1658.13	£1989.76



*In-line Panels on 1000 & 1200 products are clear glass for Alcove and Corner

Hinged Door with In-Line Panel for corner - see pages 18 - 19 for full product details

Enclosure Size (mm)	Adjustment (mm)	Door Code	In-Line Panel Code	Side Panel Code	Total Cost ex VAT	Total Cost inc VAT
1000 x 800*	965 - 980 & 765 - 780	VXL1HDR	VXL1HR10	VXHR8	£1676.06	£2011.27
1000 x 900*	965 - 980 & 865 - 880	VXL1HDR	VXL1HR10	VXHR9	£1735.29	£2082.35
1200 x 800*	1165 - 1180 & 765 - 780	VXL1HDR	VXL1HR12	VXHR8	£1837.57	£2205.08
1200 x 900*	1165 - 1180 & 865 - 880	VXL1HDR	VXL1HR12	VXHR9	£1896.80	£2276.16
1400 x 800	1365 - 1380 & 765 - 780	VXL1HDR	VXL1HR14	VXHR8	£1954.23	£2345.08
1400 x 900	1365 - 1380 & 865 - 880	VXL1HDR	VXL1HR14	VXHR9	£2013.46	£2416.15
1600 x 800	1565 - 1580 & 765 - 780	VXL1HDR	VXL1HR16	VXHR8	£2131.88	£2558.26
1600 x 900	1565 - 1580 & 865 - 880	VXL1HDR	VXL1HR16	VXHR9	£2191.11	£2629.33

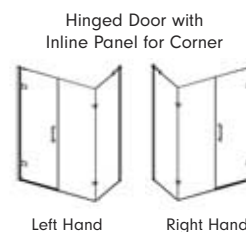

*In-line Panels on 1000 & 1200 products are clear glass for Alcove and Corner

Neo Angle Enclosure - see pages 26 - 27 for full product details

Enclosure Size (mm)	Hardware Style	Adjustment (mm)	Door Code	Neo-Panels Code	Total Cost ex VAT	Total Cost inc VAT
900 x 900	Square only	860 - 875	VXPDB	VXP9PA	£1445.87	£1735.04
1200 x 900	Square only	1160 - 1175 & 860 - 875	VXPDB	VXP129PA	£1691.97	£2030.36

N.B. 900 Neo panels are clear glass

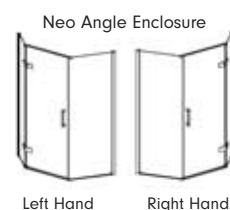

Wetroom Panel - see pages 32 - 33 for full product details

Enclosure Size (mm)	Description	Adjustment (mm)	Panel Code	Total Cost ex VAT	Total Cost inc VAT
900	Exposed Fix Wetroom Panel	865 - 880	VXFCP9	£592.19	£710.63
1200	Exposed Fix Wetroom Panel	1165 - 1180	VXFCP12	£775.76	£930.91
200	Return Panel (clear glass)	+25 to above	VXFCPL2	£269.18	£323.02
400	Return Panel (clear glass)	+25 to above	VXFCPL4	£323.01	£387.61

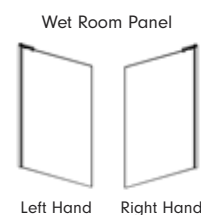

PLEASE NOTE: All Victoriana products are handed due to the print of the design being on the outside of the glass so are not reversible. Please check the handing you require from the illustrations below and state left or right handing when placing your order.

Contemporary wetroom showering

A collection of opulent open plan wetroom showering options, which stand at 2000mm high with luxury 10mm thick glass. The glass panels offer the option of either a minimalist concealed fix wall profile or a contemporary exposed fix wall profile. They can be accompanied with a fixed deflector panel to increase water integrity and can be installed onto a low level shower tray or straight to floor



1200 Corner Panel with Return Panel

- Corner Panel DXFCP12
- 'L' Return Panel DXFCPL2
- Roman Shield Wetroom System
- Shower Basket RSB05

“Simplicity is the ultimate sophistication”

- Leonardo da Vinci

GLASS THICKNESS
10
Millimetres

TOTAL HEIGHT
2030
Millimetres

REVERSIBLE

GLASS PROTECTION
ULTRA CARE
BY ROMAN

TRUETIME
LIFETIME GUARANTEE

Corner Panel

Exposed Wall Profile

Features and Benefits:

- Glass Height - 2000mm
- Total Height 2030mm with brace bar
- Surface mounted profile
- Bracing bar for optional usage supplied as standard
- Suitable for installation onto tray or wetroom floor
- Optional 'L' shaped return panel
- Due to the nature of the product water integrity cannot be guaranteed - please consult your installer



1200 Corner Panel

- Corner Panel DXFCP12
- Gloss Infinity Tray IAG129
- Shower Basket RSB05

Enclosure Size (mm)	Description	Style	Adjustment (mm)	Code	Total Cost ex VAT	Total Cost inc VAT
800	Corner Panel	Exposed	765 - 780	DXFCP8	£511.43	£613.72
900	Corner Panel	Exposed	865 - 880	DXFCP9	£538.35	£646.02
1000	Corner Panel	Exposed	965 - 980	DXFCP10	£667.56	£801.07
1200	Corner Panel	Exposed	1165 - 1180	DXFCP12	£705.24	£846.29
240	'L' Return Panel	-	+25 to above	DXFCPL2	£269.18	£323.02
440	'L' Return Panel	-	+25 to above	DXFCPL4	£323.01	£387.61

Compatible Trays:	Page
Roman Anti-Slip Trays	122 - 123
Roman Infinity Trays	124 - 125
Roman Low Level Trays	128 - 129
Roman Shield System	147

Corner Panel

Concealed Wall Profile



1200 Corner Panel

- Corner Panel DXFCP12CF
- 'L' Return Panel DXFCPL2
- Roman Shield Wetroom System
- Shower Basket RSB05

“ This minimalist piece will instantly create a boutique showering space. ”



GLASS THICKNESS
10
Millimetres

TOTAL HEIGHT
2000
Millimetres

REVERSIBLE

GLASS PROTECTION
ULTRA CARE
BY ROMAN

TRUELIFE
LIFETIME GUARANTEE

Features and Benefits:

- Concealed wall profile supplied
- Suitable for installation onto tray or wetroom floor
- Optional 'L' shaped return panel
- LBBK4590 bracing bar can be ordered if required for additional support
- Due to the nature of the product water integrity cannot be guaranteed - please consult your installer

1200 Corner Panel

- Corner Panel DXFCP12CF
- Gloss Infinity Tray IAG129
- Shower Basket RSB05



LBBK4590 Brace Bar

Corner Panel with concealed wall profile

Enclosure Size (mm)	Description	Fitting Type	Adjustment (mm)	Code	Total Cost ex VAT	Total Cost inc VAT
800	Corner Panel	Concealed	722 - 740	DXFCP8CF	£403.77	£484.52
900	Corner Panel	Concealed	822 - 840	DXFCP9CF	£436.07	£523.28
1000	Corner Panel	Concealed	922 - 940	DXFCP10CF	£559.89	£671.87
1200	Corner Panel	Concealed	1122 - 1140	DXFCP12CF	£597.58	£717.10
230	'L' Return Panel	-	+17 to above	DXFCPL2	£269.18	£323.02
430	'L' Return Panel	-	+17 to above	DXFCPL4	£323.01	£387.61
1060 (Max)	Bracing Bar	-	Cut to suit	LBBK4590	£101.97	£122.36

Compatible Trays:	Page
Roman Anti-Slip Trays	122 - 123
Roman Infinity Trays	124 - 125
Roman Low Level Trays	128 - 129
Roman Shield System	147

10mm
&
8mm

Liberty

Frameless Collection

- Hinged Door Enclosures
- Sliding Door Enclosures

Choose Door Style; Choose glass thickness; Choose frame colour; Choose silicone free wall fixing

The Liberty Collection is freed from the shackles of traditional bathroom design, with its ultra-modern and minimalist focus.

The striking minimalist look is captured with options such as door hinged straight from wall with optically clear seals.

This modern collection features a unique hydro-active wall profile sealing tape system technology, to increase water integrity, whilst also keeping with the minimalist design.

This leading collection of design led shower enclosures is perfectly completed with frame finish options of bright silver chrome, matt black, brushed nickel or polished nickel finish on all components.

The minimalist nature of the product means if the shower head is directed at seal and component interfaces, some water may escape from the showering area. The product will perform as intended under normal showering conditions.

“Colour does not add a pleasant quality to design - it reinforces it.”
- Pierre Bonard



What will your colour be...?

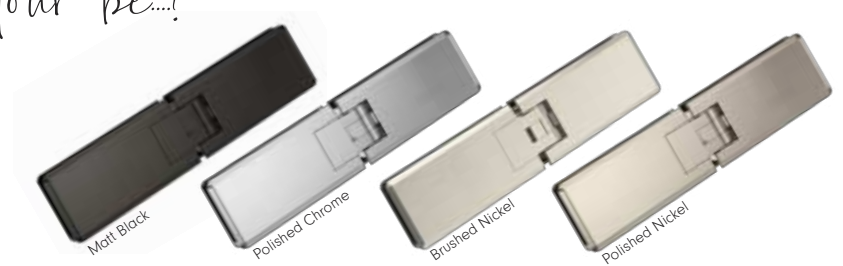

Liberty

Sliding One Door

Alcove Fitting



1200 Alcove Fitting - Brushed Nickel finish

- Right Hand Door KT1D12RN
- 1200 x 800 Anti-Slip Tray RST128

“Revolutionary minimalist sliding styling”



GLASS THICKNESS
10
Millimetres

GLASS THICKNESS
8
Millimetres

TOTAL HEIGHT
2000
Millimetres

GLASS PROTECTION
ULTRA CARE
BY ROMAN

TRUELIFE
LIFETIME
GUARANTEE

Features and Benefits:

- Quick release door function for easy cleaning
- Barrier free entry option
- Silent and ultra-smooth running roller bearing system
- Soft cushioned close system
- Unique sealing tape system technology to reduce the need for silicone
- Choice of chrome, brushed nickel, polished nickel or matt black finish
- Beautifully styled corner joints
- Silicone free wall fixing system

1200 Alcove Fitting - Brushed Nickel finish

- Right Hand Door KT1D12RN
- 1200 x 800 Anti-Slip Tray RST128

Colour options for hardware:



Please note: Handing must be specified for the correct codes to be ordered.

Alcove Fitting

Add your preferred colour letter to codes

Glass (mm)	Enclosure Size (mm)	Handing	Adjustment (mm)	Aperture (mm)	Door Code	Total Cost ex VAT	Total Cost inc VAT
8	1200	Left Hand	1166 - 1194	500	KT1D12L	£949.50	£1139.40
8	1200	Right Hand	1166 - 1194	500	KT1D12R	£949.50	£1139.40
8	1400	Left Hand	1366 - 1394	600	KT1D14L	£1039.18	£1247.02
8	1400	Right Hand	1366 - 1394	600	KT1D14R	£1039.18	£1247.02
8	1500	Left Hand	1466 - 1494	650	KT1D15L	£1084.54	£1301.45
8	1500	Right Hand	1466 - 1494	650	KT1D15R	£1084.54	£1301.45
8	1700	Left Hand	1666 - 1694	750	KT1D17L	£1175.27	£1410.32
8	1700	Right Hand	1666 - 1694	750	KT1D17R	£1175.27	£1410.32
10	1200	Left Hand	1166 - 1194	500	TT1D12L	£1063.44	£1276.13
10	1200	Right Hand	1166 - 1194	500	TT1D12R	£1063.44	£1276.13
10	1400	Left Hand	1366 - 1394	600	TT1D14L	£1163.88	£1396.66
10	1400	Right Hand	1366 - 1394	600	TT1D14R	£1163.88	£1396.66
10	1500	Left Hand	1466 - 1494	650	TT1D15L	£1214.68	£1457.62
10	1500	Right Hand	1466 - 1494	650	TT1D15R	£1214.68	£1457.62
10	1700	Left Hand	1666 - 1694	750	TT1D16L	£1316.30	£1579.56
10	1700	Right Hand	1666 - 1694	750	TT1D16R	£1316.30	£1579.56

Compatible Trays:	Page
Roman Anti-Slip Trays	122 - 123
Roman Infinity Trays	124 - 125
Roman Low Level Trays	128 - 129
Roman Shield System	147

Liberty

Sliding One Door

Corner Fitting



1700 x 800 Corner Fitting - Matt Black finish

- Right Hand Door KT1D17RCB Side Panel KTR1C8B
- 1700 x 800 Matt White Anti-Slip Tray RST178

Door open

“Beautifully styled curved corner joints”



GLASS THICKNESS
10
Millimetres

GLASS THICKNESS
8
Millimetres

TOTAL HEIGHT
2000
Millimetres

GLASS PROTECTION
ULTRA CARE
by ROMAN

TRUELIFE
LIFETIME GUARANTEE

Features and Benefits:

- Quick release door function for easy cleaning
- Barrier free entry option
- Silent and ultra-smooth running roller bearing system
- Soft cushioned close system
- Unique sealing tape system technology to reduce the need for silicone
- Choice of chrome, brushed nickel, polished nickel or matt black finish
- Beautifully styled corner joints
- Silicone free wall fixing system

1700 x 800 Corner Fitting

- Right Hand Door KT1D17RCB and Side Panel KTR1C8B
- 1700 x 800 Matt White Anti-Slip Tray RST178

Please note: Handing must be specified for the correct codes to be ordered.

Colour options for hardware:



Chrome
add S
to codes

Matt Black
add B
to codes

Brushed Nickel
add N
to codes

Polished Nickel
add PN
to codes

Corner Fitting

Add your preferred colour letter to codes

Glass (mm)	Enclosure Size (mm)	Handing	Adjustment (mm)	Aperture (mm)	Door Code	Side Panel Code	Total Cost ex VAT	Total Cost inc VAT
8	1200 x 800	Left Hand	1173 - 1187 & 773 - 787	500	KT1D12LC	KTR1C8	£1440.08	£1728.10
8	1200 x 800	Right Hand	1173 - 1187 & 773 - 787	500	KT1D12RC	KTR1C8	£1440.08	£1728.10
8	1200 x 900	Left Hand	1173 - 1187 & 873 - 887	500	KT1D12LC	KTR1C9	£1471.73	£1766.08
8	1200 x 900	Right Hand	1173 - 1187 & 873 - 887	500	KT1D12RC	KTR1C9	£1471.73	£1766.08
8	1400 x 800	Left Hand	1373 - 1387 & 773 - 787	600	KT1D14LC	KTR1C8	£1529.76	£1835.71
8	1400 x 800	Right Hand	1373 - 1387 & 773 - 787	600	KT1D14RC	KTR1C8	£1529.76	£1835.71
8	1400 x 900	Left Hand	1373 - 1387 & 873 - 887	600	KT1D14LC	KTR1C9	£1561.41	£1873.69
8	1400 x 900	Right Hand	1373 - 1387 & 873 - 887	600	KT1D14RC	KTR1C9	£1561.41	£1873.69
8	1500 x 800	Left Hand	1473 - 1487 & 773 - 787	650	KT1D15LC	KTR1C8	£1575.12	£1890.14
8	1500 x 800	Right Hand	1473 - 1487 & 773 - 787	650	KT1D15RC	KTR1C8	£1575.12	£1890.14
8	1500 x 900	Left Hand	1473 - 1487 & 873 - 887	650	KT1D15LC	KTR1C9	£1606.77	£1928.12
8	1500 x 900	Right Hand	1473 - 1487 & 873 - 887	650	KT1D15RC	KTR1C9	£1606.77	£1928.12
8	1700 x 800	Left Hand	1673 - 1687 & 773 - 787	750	KT1D17LC	KTR1C8	£1665.85	£1999.02
8	1700 x 800	Right Hand	1673 - 1687 & 773 - 787	750	KT1D17RC	KTR1C8	£1665.85	£1999.02
8	1700 x 900	Left Hand	1673 - 1687 & 873 - 887	750	KT1D17LC	KTR1C9	£1697.50	£2037.00
8	1700 x 900	Right Hand	1673 - 1687 & 873 - 887	750	KT1D17RC	KTR1C9	£1697.50	£2037.00
10	1200 x 800	Left Hand	1173 - 1187 & 773 - 787	500	TT1D12LC	TTR1C8	£1612.88	£1935.46
10	1200 x 800	Right Hand	1173 - 1187 & 773 - 787	500	TT1D12RC	TTR1C8	£1612.88	£1935.46
10	1200 x 900	Left Hand	1173 - 1187 & 873 - 887	500	TT1D12LC	TTR1C9	£1648.33	£1978.00
10	1200 x 900	Right Hand	1173 - 1187 & 873 - 887	500	TT1D12RC	TTR1C9	£1648.33	£1978.00
10	1400 x 800	Left Hand	1373 - 1387 & 773 - 787	600	TT1D14LC	TTR1C8	£1713.32	£2055.98
10	1400 x 800	Right Hand	1373 - 1387 & 773 - 787	600	TT1D14RC	TTR1C8	£1713.32	£2055.98
10	1400 x 900	Left Hand	1373 - 1387 & 873 - 887	600	TT1D14LC	TTR1C9	£1748.77	£2098.52
10	1400 x 900	Right Hand	1373 - 1387 & 873 - 887	600	TT1D14RC	TTR1C9	£1748.77	£2098.52
10	1500 x 800	Left Hand	1473 - 1487 & 773 - 787	650	TT1D15LC	TTR1C8	£1764.12	£2116.94
10	1500 x 800	Right Hand	1473 - 1487 & 773 - 787	650	TT1D15RC	TTR1C8	£1764.12	£2116.94
10	1500 x 900	Left Hand	1473 - 1487 & 873 - 887	650	TT1D15LC	TTR1C9	£1799.57	£2159.48
10	1500 x 900	Right Hand	1473 - 1487 & 873 - 887	650	TT1D15RC	TTR1C9	£1799.57	£2159.48
10	1700 x 800	Left Hand	1673 - 1687 & 773 - 787	750	TT1D17LC	TTR1C8	£1865.74	£2238.89
10	1700 x 800	Right Hand	1673 - 1687 & 773 - 787	750	TT1D17RC	TTR1C8	£1865.74	£2238.89
10	1700 x 900	Left Hand	1673 - 1687 & 873 - 887	750	TT1D17LC	TTR1C9	£1901.19	£2281.43
10	1700 x 900	Right Hand	1673 - 1687 & 873 - 887	750	TT1D17RC	TTR1C9	£1901.19	£2281.43

Compatible Trays:	Page
Roman Anti-Slip Trays	122 - 123
Roman Infinity Trays	124 - 125
Roman Low Level Trays	128 - 129
Roman Shield System	147

Two Sliding Doors



1700 x 800 Corner Fitting - Brushed Nickel finish

- Door KT2D17C1N and KTR2C8N
- 1700 x 800 Matt White Anti-Slip Tray RST178

“ Ultra-smooth and silent running action ”



GLASS THICKNESS
10
Millimetres

GLASS THICKNESS
8
Millimetres

TOTAL HEIGHT
2000
Millimetres

REVERSIBLE

GLASS PROTECTION
ULTRA CARE
BY ROMAN

TRULIFE
LIFETIME GUARANTEE

Features and Benefits:

- Quick release door function for easy cleaning
- Barrier free entry option
- Silent and ultra-smooth running roller bearing system
- Soft cushioned close system
- Unique sealing tape system technology to reduce the need for silicone
- Choice of chrome, brushed nickel, polished nickel or matt black finish
- Beautifully styled corner joints
- Silicone free wall fixing system



1700 Alcove Fitting - Brushed Nickel finish

- Door KT2D17N
- 1700 x 800 Matt White Anti-Slip Tray RST178



Alcove Fitting

Add your preferred colour letter to codes

Glass (mm)	Enclosure Size (mm)	Adjustment (mm)	Aperture (mm)	Door Code	Total Cost ex VAT	Total Cost inc VAT
8	1600	1566 - 1594	645	KT2D16	£1156.00	£1387.20
8	1700	1666 - 1694	695	KT2D17	£1264.95	£1517.94
8	1800	1766 - 1794	745	KT2D18	£1310.31	£1572.37
10	1600	1566 - 1594	645	TT2D16	£1365.93	£1639.12
10	1700	1666 - 1694	695	TT2D17	£1416.74	£1700.09
10	1800	1766 - 1794	745	TT2D18	£1467.55	£1761.06

Colour options for hardware:



Chrome
add S
to codes

Matt Black
add B
to codes

Brushed Nickel
add N
to codes

Polished Nickel
add PN
to codes

Corner Fitting

Add your preferred colour letter to codes

Glass (mm)	Enclosure Size (mm)	Adjustment (mm)	Aperture (mm)	Door Code	Side Panel Code	Total Cost ex VAT	Total Cost inc VAT
8	1600 x 800	1573 - 1587 & 773 - 787	645	KT2D16C1	KTR2C8	£1646.58	£1975.90
8	1600 x 900	1673 - 1687 & 873 - 887	645	KT2D17C1	KTR2C9	£1678.23	£2013.88
8	1700 x 800	1673 - 1687 & 773 - 787	695	KT2D17C1	KTR2C8	£1755.53	£2106.64
8	1700 x 900	1673 - 1687 & 873 - 887	695	KT2D17C1	KTR2C9	£1787.18	£2144.62
8	1800 x 800	1773 - 1787 & 773 - 787	745	KT2D18C1	KTR2C8	£1800.89	£2161.07
10	1600 x 800	1573 - 1587 & 773 - 787	645	TT2D16C1	TTR2C8	£1915.37	£2298.44
10	1600 x 900	1573 - 1587 & 873 - 887	645	TT2D16C1	TTR2C9	£1950.82	£2340.98
10	1700 x 800	1673 - 1687 & 773 - 787	695	TT2D17C1	TTR2C8	£1966.18	£2359.42
10	1700 x 900	1673 - 1687 & 873 - 887	695	TT2D17C1	TTR2C9	£2001.63	£2401.96
10	1800 x 800	1773 - 1787 & 773 - 787	745	TT2D18C1	TTR2C8	£2016.99	£2420.39

Compatible Trays:	Page
Roman Anti-Slip Trays	122 - 123
Roman Infinity Trays	124 - 125
Roman Low Level Trays	128 - 129
Roman Shield System	147

Two Sliding Doors

with two in-line panels and two side panels



1800 x 800 3 Sided Enclosure - Matt Black finish

- Door KT2D18C2B and Side Panel KTR3C8B
- 1800 x 800 Matt White Anti-Slip Tray RST178

“ Everything is designed -
few things are designed well ”

GLASS THICKNESS
10
Millimetres

GLASS THICKNESS
8
Millimetres

TOTAL HEIGHT
2000
Millimetres

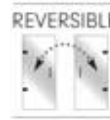

GLASS PROTECTION
ULTRA CARE
BY REVIAN

TRUETIME
LIFETIME
GUARANTEE



Features and Benefits:

- Quick release door function for easy cleaning
- Barrier free entry option
- Silent and ultra-smooth running roller bearing system
- Soft cushioned close system
- Unique sealing tape system technology to reduce the need for silicone
- Choice of chrome, brushed nickel, polished nickel or matt black finish
- Beautifully styled corner joints
- Silicone free wall fixing system



Colour options for hardware:



Chrome
add S
to codes

Matt Black
add B
to codes

Brushed Nickel
add N
to codes

Polished Nickel
add PN
to codes

3 Sided Enclosure

Add your preferred colour letter to codes

Glass (mm)	Enclosure Size (mm)	Side Panel Adjustment (mm)	Aperture (mm)	Door Code	Side Panel Pack Code*	Total Cost ex VAT	Total Cost inc VAT
8	1600 x 800	773 - 787	645	KT2D16C2	KTR3C8	£2137.15	£2564.58
8	1600 x 900	873 - 887	645	KT2D16C2	KTR3C9	£2200.45	£2640.54
8	1700 x 800	773 - 787	695	KT2D17C2	KTR3C8	£2246.10	£2695.32
8	1700 x 900	873 - 887	695	KT2D17C2	KTR3C9	£2309.40	£2771.28
8	1800 x 800	773 - 787	745	KT2D18C2	KTR3C8	£2291.46	£2749.75
10	1600 x 800	773 - 787	645	TT2D16C2	TTR3C8	£2464.82	£2957.78
10	1600 x 900	873 - 887	645	TT2D16C2	TTR3C9	£2535.71	£3042.85
10	1700 x 800	773 - 787	695	TT2D17C2	TTR3C8	£2515.63	£3018.76
10	1700 x 900	873 - 887	695	TT2D17C2	TTR3C9	£2586.52	£3103.82
10	1800 x 800	773 - 787	745	TT2D18C2	TTR3C8	£2566.44	£3079.73

*Side Panel Code is pack of 2 side panels

Compatible Trays:	Page
Roman Anti-Slip Trays	122 - 123
Roman Infinity Trays	124 - 125
Roman Low Level Trays	128 - 129
Roman Shield System	147

Hinged Door



900 x 900 Corner Fitting - Chrome finish

- 8mm Door KL913CS and Side Panel KR913S
- 900 x 900 Roman Low Level Tray RLT90
- Shower Basket RSB01

“Door hinged straight from the wall for a sleek minimalist look”



900 Alcove Fitting - Brushed Nickel finish

- 8mm Door KL913
- 900 x 900 Roman Low Level Tray RLT90
- Shower Basket RSB02

GLASS THICKNESS
10
Millimetres

GLASS THICKNESS
8
Millimetres

TOTAL HEIGHT
2000
Millimetres

REVERSIBLE

GLASS PROTECTION
ULTRA CARE
BY ROMAN

TRULIFE
LIFETIME
GUARANTEE

Features and Benefits:

- Hinged from wall
- New clear and minimal seals
- New minimal easy fix wall profile system
- Choice of colour finishes for hardware
- Unique sealing tape system technology to reduce the need for silicone
- Integrated 'tray or floor' Water Safe System
- Designed for installation to straight vertical walls
- Silicone Free Wall Fixing

Colour options for hardware:



Chrome
add S
to codes

Matt Black
add B
to codes

Brushed Nickel
add N
to codes

Polished Nickel
add PN
to codes

Add your preferred colour letter to codes

Alcove Fitting - inward or outward opening

Please note - lead time of 3 - 4 weeks for alcove door

Glass (mm)	Description	Size (mm)	Adjustment (mm)	Aperture (mm)	Code	Total Cost ex VAT	Total Cost inc VAT
8	Hinged Door for Alcove	760	735 - 745	710	KL7613	£736.12	£883.34
8	Hinged Door for Alcove	800	775 - 785	750	KL813	£743.36	£892.03
8	Hinged Door for Alcove	900	875 - 885	850	KL913	£751.14	£901.37
8	Hinged Door for Alcove	1000	975 - 985	950	KL1013	£758.56	£910.27
10	Hinged Door for Alcove	760	735 - 745	710	TL7613	£800.14	£960.17
10	Hinged Door for Alcove	800	775 - 785	750	TL813	£808.30	£969.96
10	Hinged Door for Alcove	900	875 - 885	850	TL913	£816.46	£979.75
10	Hinged Door for Alcove	1000	975 - 985	950	TL1013	£824.52	£989.42

Corner Fitting - outward opening only

Glass (mm)	Description	Size (mm)	Adjustment (mm)	Aperture (mm)	Code	Total Cost ex VAT	Total Cost inc VAT
8	Hinged Door for Corner	760	0	720	KL7613C	£595.97	£715.16
8	Hinged Door for Corner	800	0	760	KL813C	£605.64	£726.77
8	Hinged Door for Corner	900	0	860	KL913C	£615.34	£738.41
8	Hinged Door for Corner	1000	0	960	KL1013C	£625.03	£750.04
8	Side Panel	760	733 - 747	-	KR7613	£595.97	£715.16
8	Side Panel	800	773 - 787	-	KR813	£605.64	£726.77
8	Side Panel	900	873 - 887	-	KR913	£615.34	£738.41
8	Side Panel	1000	973 - 987	-	KR1013	£625.03	£750.04
10	Hinged Door for Corner	760	0	720	TL7613C	£629.07	£754.88
10	Hinged Door for Corner	800	0	760	TL813C	£639.29	£767.15
10	Hinged Door for Corner	900	0	860	TL913C	£649.52	£779.42
10	Hinged Door for Corner	1000	0	960	TL1013C	£659.76	£791.71
10	Side Panel	760	733 - 747	-	TR7613	£629.07	£754.88
10	Side Panel	800	773 - 787	-	TR813	£639.29	£767.15
10	Side Panel	900	873 - 887	-	TR913	£649.52	£779.42
10	Side Panel	1000	973 - 987	-	TR1013	£659.76	£791.71

Compatible Trays:	Page
Roman Anti-Slip Trays	122 - 123
Roman Infinity Trays	124 - 125
Roman Low Level Trays	128 - 129
Roman Shield System	147

Hinged Door

with one in-line panel

Inward or Outward Opening



1000 Alcove Fitting - Brushed Nickel finish

- 8mm Door KL1HD13N and In-Line Panel KL1H1013N
- Roman Low Level Tray RLT108
- Shower Basket RSB02

“ It presents you with the choice of brushed nickel, polished nickel, silver chrome or matt black finish on all components including the elongated sleek hinges, designer handle and bracing bar. ”



GLASS THICKNESS
10
Millimetres

GLASS THICKNESS
8
Millimetres

TOTAL HEIGHT
2000
Millimetres



Features and Benefits:

- Hinged from wall
- New clear and minimal seals
- New minimal easy fix wall profile system
- Adjustable hinges for Inward or Outward opening door
- Choice of colour finishes for hardware
- Unique sealing tape system technology to reduce the need for silicone
- Integrated 'tray or floor' Water Safe System
- Designed for installation to straight vertical walls
- Silicone Free Wall Fixing

Colour options for hardware:



Chrome
add S
to codes

Matt Black
add B
to codes

Brushed Nickel
add N
to codes

Polished Nickel
add PN
to codes

1200 x 900 Corner Fitting - Brushed Nickel finish

- 8mm Door KL1HDR13N, In-Line Panel KL1HR1213N and Side Panel KHR913N
- Gloss Infinity Tray IAG129
- Shower Basket RSB02

Alcove Fitting

Add your preferred colour letter to codes

Glass (mm)	Enclosure Size (mm)	Adjustment (mm)	Aperture (mm)	Door Code	In-Line Panel Code	Total Cost ex VAT	Total Cost inc VAT
8	760	733 - 747	500	KL1HD213	KL1H7613	£896.90	£1076.28
8	800	773 - 787	500	KL1HD213	KL1H813	£906.05	£1087.26
8	900	873 - 887	640	KL1HD13	KL1H913	£915.20	£1098.24
8	1000	973 - 987	640	KL1HD13	KL1H1013	£1006.73	£1208.08
8	1200	1173 - 1187	640	KL1HD13	KL1H1213	£1098.24	£1317.89
8	1400	1373 - 1389	640	KL1HD13	KL1H1413	£1189.77	£1427.72
8	1600	1573 - 1587	640	KL1HD13	KL1H1613	£1281.28	£1537.54
10	760	733 - 747	500	TL1HD213	TL1H7613	£973.85	£1168.62
10	800	773 - 787	500	TL1HD213	TL1H813	£1022.86	£1227.43
10	900	873 - 887	640	TL1HD13	TL1H913	£1071.87	£1286.24
10	1000	973 - 987	640	TL1HD13	TL1H1013	£1125.16	£1350.19
10	1200	1173 - 1187	640	TL1HD13	TL1H1213	£1227.44	£1472.93
10	1400	1373 - 1387	640	TL1HD13	TL1H1413	£1329.73	£1595.68
10	1600	1573 - 1587	640	TL1HD13	TL1H1613	£1432.02	£1718.42



Corner Fitting

Add your preferred colour letter to codes

Glass (mm)	Enclosure Size (mm)	Adjustment (mm)	Aperture (mm)	Door Code	In-Line Panel Code	Side Panel Code	Total Cost ex VAT	Total Cost inc VAT
8	1000 x 800	773 - 787	667	KL1HDR13	KL1HR1013	KHR813	£1405.09	£1686.11
8	1000 x 900	873 - 887	667	KL1HDR13	KL1HR1013	KHR913	£1453.56	£1744.27
8	1200 x 800	773 - 787	667	KL1HDR13	KL1HR1213	KHR813	£1550.44	£1860.53
8	1200 x 900	873 - 887	667	KL1HDR13	KL1HR1213	KHR913	£1598.91	£1918.69
8	1400 x 800	773 - 787	667	KL1HDR13	KL1HR1413	KHR813	£1598.91	£1918.69
8	1400 x 900	873 - 887	667	KL1HDR13	KL1HR1413	KHR913	£1647.38	£1976.86
8	1600 x 800	773 - 787	667	KL1HDR13	KL1HR1613	KHR813	£1744.26	£2093.11
10	1000 x 800	773 - 787	667	TL1HDR13	TL1HR1013	THR813	£1485.17	£1779.80
10	1000 x 900	873 - 887	667	TL1HDR13	TL1HR1013	THR913	£1534.32	£1841.18
10	1200 x 800	773 - 787	667	TL1HDR13	TL1HR1213	THR813	£1636.60	£1963.92
10	1200 x 900	873 - 887	667	TL1HDR13	TL1HR1213	THR913	£1687.75	£2025.30
10	1400 x 800	773 - 787	667	TL1HDR13	TL1HR1413	THR813	£1687.75	£2025.30
10	1400 x 900	873 - 887	667	TL1HDR13	TL1HR1413	THR913	£1738.90	£2086.68
10	1600 x 800	773 - 787	667	TL1HDR13	TL1HR1613	THR813	£1841.18	£2209.42

Compatible Trays:	Page
Roman Anti-Slip Trays	122 - 123
Roman Infinity Trays	124 - 125
Roman Low Level Trays	128 - 129
Roman Shield System	147

Hinged Door

with two in-line panels

Inward or Outward Opening



1600 Alcove Fitting - Chrome finish

- 8mm Door KLHD13S and In-Line Panel KLH1613S
- 1600 x 800 Gloss Infinity Tray IAG168
- Shower Basket RSB05

“Cleverly use the alcove space in your bathroom with the frameless hinged door with two in-line panels.”



GLASS THICKNESS
10
Millimetres

GLASS THICKNESS
8
Millimetres

TOTAL HEIGHT
2000
Millimetres



GLASS PROTECTION
ULTRA CARE
BY ROMAN

TRUELIFE
LIFETIME GUARANTEE

Features and Benefits:

- Hinged from In-Line Panel
- New clear and minimal seals
- New minimal easy fix wall profile system
- Adjustable hinges for Inward or Outward opening door
- Choice of colour finishes for hardware
- Unique sealing tape system technology to reduce the need for silicone
- Integrated 'tray or floor' Water Safe System
- Designed for installation to straight vertical walls
- Silicone Free Wall Fixing

1600 x 800 Corner Fitting - Chrome finish

- 8mm Door KLHDR13S, In-Line Panel KLHR1613S and Side Panel KHR813S
- 1600 x 800 Gloss Infinity Tray IAG168
- Shower Basket RSB01

Colour options for hardware:



Chrome
add S
to codes

Matt Black
add B
to codes

Brushed Nickel
add N
to codes

Polished Nickel
add PN
to codes

Alcove Fitting

Add your preferred colour letter to codes

Glass (mm)	Enclosure Size (mm)	Adjustment (mm)	Aperture (mm)	Door Code	In-Line Panel Code*	Total Cost ex VAT	Total Cost inc VAT
8	1200	1166 - 1194	653	KLHD13	KLH1213	£1169.76	£1403.71
8	1400	1366 - 1394	653	KLHD13	KLH1413	£1267.25	£1520.70
8	1600	1566 - 1594	653	KLHD13	KLH1613	£1364.72	£1637.66
10	1200	1166 - 1194	653	TLHD13	TLH1213	£1307.38	£1568.86
10	1400	1366 - 1394	653	TLHD13	TLH1413	£1416.33	£1699.60
10	1600	1566 - 1594	653	TLHD13	TLH1613	£1525.27	£1830.32

Compatible Trays:	Page
Roman Anti-Slip Trays	122 - 123
Roman Infinity Trays	124 - 125
Roman Low Level Trays	128 - 129
Roman Shield System	147

Corner Fitting

Add your preferred colour letter to codes

Glass (mm)	Enclosure Size (mm)	Adjustment (mm) Door and In-Line Panel	Adjustment (mm) Side Panel	Door Aperture (mm)	Door Code	In-Line Panel Code*	Side Panel Code	Total Cost ex VAT	Total Cost inc VAT
8	1200 x 800	1173 - 1187	773 - 787	653	KLHDR13	KLHR1213	KHR813	£1617.74	£1941.29
8	1200 x 900	1173 - 1187	873 - 887	653	KLHDR13	KLHR1213	KHR913	£1666.21	£1999.45
8	1400 x 800	1373 - 1387	773 - 787	653	KLHDR13	KLHR1413	KHR813	£1669.37	£2003.24
8	1400 x 900	1373 - 1387	873 - 887	653	KLHDR13	KLHR1413	KHR913	£1717.84	£2061.41
8	1600 x 800	1573 - 1587	773 - 787	653	KLHDR13	KLHR1613	KHR813	£1824.19	£2189.03
8	1600 x 900	1573 - 1587	873 - 887	653	KLHDR13	KLHR1613	KHR913	£1872.66	£2247.19
10	1200 x 800	1173 - 1187	773 - 787	653	TLHDR13	TLHR1213	THR813	£1707.64	£2049.17
10	1200 x 900	1173 - 1187	873 - 887	653	TLHDR13	TLHR1213	THR913	£1758.79	£2110.55
10	1400 x 800	1373 - 1387	773 - 787	653	TLHDR13	TLHR1413	THR813	£1762.13	£2114.56
10	1400 x 900	1373 - 1387	873 - 887	653	TLHDR13	TLHR1413	THR913	£1813.28	£2175.94
10	1600 x 800	1573 - 1587	773 - 787	653	TLHDR13	TLHR1613	THR813	£1925.55	£2310.66
10	1600 x 900	1573 - 1587	873 - 887	653	TLHDR13	TLHR1613	THR913	£1976.70	£2372.04

*In-Line Panel Code is pack of 2 panels

Liberty

Hinged Door

with hinged in-line panel

Outward Opening



1200 x 900 Corner Fitting - Matt Black finish

- 8mm Door KL2HDR13B, In-Line Panel KL2HR1213B, Side Panel K1R913B
- 1200 x 900 Black Shimmer Infinity Tray IAG129B
- Shower Basket RSB03

“Keep your bathroom at the forefront of fashion with the luxuriously minimalist Liberty Collection.”



GLASS THICKNESS
10
Millimetres

GLASS THICKNESS
8
Millimetres

TOTAL HEIGHT
2000
Millimetres

REVERSIBLE

GLASS PROTECTION
ULTRA CARE
BY ROMAN

TRUELIFE
LIFETIME GUARANTEE

Features and Benefits:

- Hinged from In-Line Panel
- New clear and minimal seals
- New minimal easy fix wall profile system
- Choice of colour finishes for hardware
- Unique sealing tape system technology to reduce the need for silicone
- Integrated 'tray or floor' Water Safe System
- Designed for installation to straight vertical walls
- Silicone Free Wall Fixing

Colour options for hardware:



Chrome
add S
to codes

Matt Black
add B
to codes

Brushed Nickel
add N
to codes

Polished Nickel
add PN
to codes

1200 Alcove Fitting - Chrome finish

- 8mm Door KL2HD13S and In-Line Panel KL2H1213S
- 1200 x 900 Gloss White Infinity Tray IAG129
- Shower Basket RSB03

Alcove Fitting Outward or Inward Opening Add your preferred colour letter to codes

Glass (mm)	Enclosure Size (mm)	Adjustment (mm)	Door Aperture (mm)	Door Code	In-Line Panel Code	Total Cost ex VAT	Total Cost inc VAT
8	1000	970 - 994	760	KL2HD13	KL2H1013	£1078.19	£1293.83
8	1200	1170 - 1194	760	KL2HD13	KL2H1213	£1169.76	£1403.71
10	1000	970 - 994	760	TL2HD13	TL2H1013	£1198.42	£1438.10
10	1200	1170 - 1194	760	TL2HD13	TL2H1213	£1307.37	£1568.84



Matt Black finish

Corner Fitting Outward Opening only Add your preferred colour letter to codes

Glass (mm)	Enclosure Size (mm)	Adjustment (mm) Door and In-Line Panel	Adjustment (mm) Side Panel	Door Aperture (mm)	Door Code	In-Line Panel Code	Side Panel Code	Total Cost ex VAT	Total Cost inc VAT
8	1000 x 760	973 - 987	733 - 747	760	KL2HDR13	KL2HR1013	K1R7613	£1415.03	£1698.04
8	1000 x 800	973 - 987	773 - 787	760	KL2HDR13	KL2HR1013	K1R813	£1463.49	£1756.19
8	1000 x 900	973 - 987	873 - 887	760	KL2HDR13	KL2HR1013	K1R913	£1511.93	£1814.32
8	1000 x 1000	973 - 987	973 - 987	760	KL2HDR13	KL2HR1013	K1R1013	£1608.85	£1930.62
8	1200 x 760	1173 - 1187	733 - 747	760	KL2HDR13	KL2HR1213	K1R7613	£1569.85	£1883.82
8	1200 x 800	1173 - 1187	773 - 787	760	KL2HDR13	KL2HR1213	K1R813	£1618.31	£1941.97
8	1200 x 900	1173 - 1187	873 - 887	760	KL2HDR13	KL2HR1213	K1R913	£1666.75	£2000.10
8	1200 x 1000	1173 - 1187	973 - 987	760	KL2HDR13	KL2HR1213	K1R1013	£1763.67	£2116.40
10	1000 x 760	973 - 987	733 - 747	760	TL2HDR13	TL2HR1013	T1R7613	£1493.63	£1792.36
10	1000 x 800	973 - 987	773 - 787	760	TL2HDR13	TL2HR1013	T1R813	£1544.78	£1853.74
10	1000 x 900	973 - 987	873 - 887	760	TL2HDR13	TL2HR1013	T1R913	£1595.92	£1915.10
10	1000 x 1000	973 - 987	973 - 987	760	TL2HDR13	TL2HR1013	T1R1013	£1698.22	£2037.86
10	1200 x 760	1173 - 1187	733 - 747	760	TL2HDR13	TL2HR1213	T1R7613	£1657.05	£1988.46
10	1200 x 800	1173 - 1187	773 - 787	760	TL2HDR13	TL2HR1213	T1R813	£1708.20	£2049.84
10	1200 x 900	1173 - 1187	873 - 887	760	TL2HDR13	TL2HR1213	T1R913	£1759.34	£2111.21
10	1200 x 1000	1173 - 1187	973 - 987	760	TL2HDR13	TL2HR1213	T1R1013	£1861.64	£2233.97

Compatible Trays:	Page
Roman Anti-Slip Trays	122 - 123
Roman Infinity Trays	124 - 125
Roman Low Level Trays	128 - 129
Roman Shield System	147

8mm Innov8

Frameless Collection

- Pivot Doors
- Bi-Fold Doors
- Wetroom Panels

The Innov8 Collection encompasses elegantly minimalist frameless Pivot Door and Bi-Fold Door Enclosures. These frameless enclosures lead the way in minimal, inclusive and stylish design trends, presenting a distinctively modern collection.

Innov8's outstanding differential is the low threshold (reduced height of the bottom rail), allowing level entry access into the shower enclosure. The elimination of the top rail and profiles (when configured with a side or in-line panel) and the low threshold, encapsulates the minimalist styling, whilst still retaining the water integrity and adjustments of a standard shower enclosure.

The minimalist nature of the product means if the shower head is directed at seal and component interfaces, some water may escape from the showering area. The product will perform as intended under normal showering conditions.

“ Design is not just what it looks like
and feels like. Design is how it works. ”

- Steve Jobs



Pivot Door

Outward Opening



900 x 900 Corner Fitting

- Door N2F913CS
- Side Panel N2R913S
- Roman Low Level Tray RLT9
- Shower Basket RSB07

“ A minimalist design with its frameless look presenting inclusivity for all users with its low threshold ”



900 Alcove Fitting

- Door N2F913S
- Roman Low Level Tray RLT9
- Shower Basket RSB07

GLASS THICKNESS
8
Millimetres

TOTAL HEIGHT
1967
Millimetres

REVERSIBLE

GLASS PROTECTION
ULTRA CARE
BY ROMAN

TRUELIFE
LIFETIME GUARANTEE

Features and Benefits:

- Glass Height 1950mm
- Height to top of pivot tube 1967mm
- Bright Silver frame
- Chromed brass machined components
- Chromed brass feature handle
- Low profile PVC seals
- 20mm of adjustment in each profile
- No top rail
- Full length pivoting tube
- Side Panels supplied with optional bracing
- Outward opening only



Corner Fitting

Enclosure Size (mm)	Description	Adjustment (mm)	Door Aperture (mm)	Code	Total Cost ex VAT	Total Cost inc VAT
760	Door	715 - 735	630	N2F7613CS	£520.67	£624.80
800	Door	755 - 775	670	N2F813CS	£520.67	£624.80
900	Door	855 - 875	770	N2F913CS	£561.25	£673.50
760	Side Panel	715 - 735	-	N2R7613S	£336.95	£404.34
800	Side Panel	755 - 775	-	N2R813S	£336.95	£404.34
900	Side Panel	855 - 875	-	N2R913S	£364.72	£437.66

Alcove Fitting

Enclosure Size (mm)	Description	Adjustment (mm)	Door Aperture (mm)	Code	Total Cost ex VAT	Total Cost inc VAT
760	Door	710 - 750	600	N2F7613S	£520.67	£624.80
800	Door	750 - 790	640	N2F813S	£520.67	£624.80
900	Door	850 - 890	740	N2F913S	£561.25	£673.50

Compatible Trays:	Page
Roman Anti-Slip Trays	122 - 123
Roman Infinity Trays	124 - 125
Roman Low Level Trays	128 - 129
Roman Shield System	147

Pivot Door

with In-Line Panel

Inward or Outward Opening



1200 Alcove Fitting

- Door N2F1HD13S
- In-Line Panel N2H1213S
- Anti Slip Tray RST129
- Shower Basket RSB02

“ This frameless Pivot Door introduces a distinctive minimalist look, inclusive design and supreme functionality ”



1200 x 900 Corner Fitting

- Door N2F1HDR13S
- Side Panel N2HR913S
- In-Line Panel N2HR1213S
- Anti Slip Tray RST129
- Shower Basket RSB02

GLASS THICKNESS
8
Millimetres

TOTAL HEIGHT
1967
Millimetres

REVERSIBLE

GLASS PROTECTION
ULTRA CARE
BY ROMAN

TRUELIFE
LIFETIME GUARANTEE

Features and Benefits:

- Glass Height 1950mm
- Height to top of pivot tube 1967mm
- Bright Silver frame
- Chromed brass machined components
- Chromed brass feature handle
- Low profile PVC seals
- 20mm of adjustment in each profile
- No top rail
- Can be installed for inward or outward opening
- Full length pivoting tube
- In-Line Panels supplied with optional bracing



Corner Fitting

Enclosure Size (mm)	Adjustment (mm) Door and In-Line	Adjustment (mm) Side Panel	Door Aperture (mm)	Door Code	In-Line Panel Code	Side Panel Code	Total Cost ex VAT	Total Cost inc VAT
1000 x 800	955 - 975	755 - 775	585	N2F1HDR13S	N2HR1013S	N2HR813S	£1110.39	£1332.47
1000 x 900	955 - 975	855 - 875	585	N2F1HDR13S	N2HR1013S	N2HR913S	£1138.16	£1365.79
1200 x 800	1155 - 1175	755 - 775	585	N2F1HDR13S	N2HR1213S	N2HR813S	£1154.69	£1385.63
1200 x 900	1155 - 1175	855 - 875	585	N2F1HDR13S	N2HR1213S	N2HR913S	£1182.46	£1418.95
1400 x 800	1355 - 1375	755 - 775	640	N2F2HDR13S	N2HR1413S	N2HR813S	£1199.81	£1439.77
1400 x 900	1355 - 1375	855 - 875	640	N2F2HDR13S	N2HR1413S	N2HR913S	£1227.58	£1473.10
1500 x 800	1455 - 1475	755 - 775	640	N2F2HDR13S	N2HR1513S	N2HR813S	£1244.93	£1493.92
1500 x 900	1455 - 1475	855 - 875	640	N2F2HDR13S	N2HR1513S	N2HR913S	£1272.70	£1527.24

Alcove Fitting

Enclosure Size (mm)	Adjustment (mm)	Door Aperture (mm)	Door Code	In-Line Panel Code	Total Cost ex VAT	Total Cost inc VAT
1000	950 - 990	585	N2F1HD13S	N2H1013S	£773.44	£928.13
1200	1150 - 1190	585	N2F1HD13S	N2H1213S	£817.74	£981.29
1400	1350 - 1390	640	N2F2HD13S	N2H1413S	£862.86	£1035.43
1500	1450 - 1490	640	N2F2HD13S	N2H1513S	£907.98	£1089.58

Compatible Trays:	Page
Roman Anti-Slip Trays	122 - 123
Roman Infinity Trays	124 - 125
Roman Low Level Trays	128 - 129
Roman Shield System	147

Bi-Fold Door

Inward Opening



900 x 900 Corner Fitting

- Door N2V913CS
- Side Panel N2R913S
- Roman Tray RLT90

“Roman has once again innovated to remove top and bottom framing.”

GLASS THICKNESS
8
Millimetres

TOTAL HEIGHT
1967
Millimetres

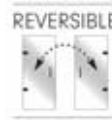

GLASS PROTECTION
ULTRA CARE
BY ROMAN

TRUELIFE
LIFETIME
GUARANTEE

Features and Benefits:

- Frameless inward opening doors with 180° pivoting action
- Bright silver profile
- Chromed brass hinges
- Chromed brass top caps
- Clear seals
- No top rail
- Elimination of the bottom rail creating level access entry



900 Alcove Fitting

- Door N2V913S
- Roman Tray RLT90



900 x 900 Corner Fitting closed

- x2 Doors N2V913CS

Corner Fitting (Door and Side Panel)

Enclosure Size (mm)	Description	Adjustment (mm)	Door Aperture (mm)	Code	Total Cost ex VAT	Total Cost inc VAT
760	Bi-Fold Door	715 - 735	620	N2V7613CS	£638.28	£765.94
800	Bi-Fold Door	755 - 775	660	N2V813CS	£638.28	£765.94
900	Bi-Fold Door	855 - 875	760	N2V913CS	£685.75	£822.90
1000	Bi-Fold Door	955 - 975	860	N2V1013CS	£733.23	£879.88
760	Side Panel	715 - 735	-	N2R7613S	£336.95	£404.34
800	Side Panel	755 - 775	-	N2R813S	£336.95	£404.34
900	Side Panel	855 - 875	-	N2R913S	£364.72	£437.66
1000	Side Panel	955 - 975	-	N2R1013S	£395.63	£474.76

Alcove Fitting

Enclosure Size (mm)	Description	Adjustment (mm)	Door Aperture (mm)	Door Code	Total Cost ex VAT	Total Cost inc VAT
760	Bi-Fold Door	710 - 750	590	N2V7613S	£638.28	£765.94
800	Bi-Fold Door	750 - 790	630	N2V813S	£638.28	£765.94
900	Bi-Fold Door	850 - 890	730	N2V913S	£685.75	£822.90
1000	Bi-Fold Door	950 - 990	830	N2V1013S	£733.23	£879.88

Corner Fitting (2 Bi-Fold Doors)

Enclosure Size (mm)	Adjustment (mm)	Door Aperture (mm)	Door Code	Total Cost ex VAT*	Total Cost inc VAT*
800 x 800	755 - 775	660	N2V813CS	£1276.56	£1531.87
900 x 900	855 - 875	760	N2V913CS	£1371.50	£1645.80
1000 x 1000	955 - 975	860	N2V1013CS	£1466.46	£1759.75

* Price is total cost for x2 doors - order must be for x2 door codes

Please note: This 2 door configuration is for a wetroom fitting solution only and is not recommended for fitting to a shower tray



Open

Compatible Trays:	Page
Roman Anti-Slip Trays	122 - 123
Roman Infinity Trays	124 - 125
Roman Low Level Trays	128 - 129
Roman Shield System	147

Bi-Fold Door

with in-line panel

Inward Opening



1400 Alcove Fitting

- Door N2VHD13S
- In-Line Panel N2H1413S
- Roman Anti-Slip Tray RST149

“ The minimalist and flexible design of this frameless enclosure presents inclusivity for all users with its level access entry and no height restriction. ”

Features and Benefits:

- Frameless inward opening doors with 180° pivoting action
- Bright silver profile
- Chromed brass hinges
- Chromed brass top caps
- Clear seals
- No top rail and elimination of the bottom rail creating level access entry

GLASS THICKNESS
8
Millimetres

TOTAL HEIGHT
1967
Millimetres

REVERSIBLE

GLASS PROTECTION
ULTRA CARE
by ROMAN

TRULIFE

LIFETIME GUARANTEE



1400 x 900 Corner Fitting

- Door N2VHDR13S
- Side Panel N2HR913S
- In-Line Panel N2HR1413S
- Roman Anti-Slip Tray RST149

Corner Fitting

Enclosure Size (mm)	Adjustment (mm) Door	Adjustment (mm) Side Panel	Aperture (mm)	Door Code	In-Line Panel Code	Side Panel Code	Total Cost ex VAT	Total Cost inc VAT
1200 x 800	1155 - 1175	755 - 775	630	N2VHDR13S	N2VHR1213S	N2HR813S	£1319.76	£1583.71
1200 x 900	1155 - 1175	855 - 875	630	N2VHDR13S	N2VHR1213S	N2HR913S	£1347.53	£1617.04
1400 x 800	1355 - 1375	755 - 775	630	N2VHDR13S	N2HR1413S	N2HR813S	£1364.89	£1637.87
1400 x 900	1355 - 1375	855 - 875	630	N2VHDR13S	N2HR1413S	N2HR913S	£1392.66	£1671.19
1500 x 800	1455 - 1475	755 - 775	630	N2VHDR13S	N2HR1513S	N2HR813S	£1410.01	£1692.01
1500 x 900	1455 - 1475	855 - 875	630	N2VHDR13S	N2HR1513S	N2HR913S	£1437.78	£1725.34

Alcove Fitting

Enclosure Size (mm)	Adjustment (mm)	Aperture (mm)	Door Code	In-Line Panel Code	Total Cost ex VAT	Total Cost inc VAT
1200	1150 - 1190	630	N2VHD13S	N2VH1213S	£982.81	£1179.37
1400	1350 - 1390	630	N2VHD13S	N2H1413S	£1027.94	£1233.53
1500	1450 - 1490	630	N2VHD13S	N2H1513S	£1073.06	£1287.67

Compatible Trays:

Roman Anti-Slip Trays	122 - 123
Roman Infinity Trays	124 - 125
Roman Low Level Trays	128 - 129
Roman Shield System	147

Page

122 - 123
124 - 125
128 - 129
147

8mm
&
6mm

Lumin8

Semi-Frameless Collection

This compelling and contemporary collection of showering solutions meets all your requirements, whilst bringing an inviting touch of luxury into your bathroom.

Meticulously designed to solve a variety of space restrictions in the bathroom, whilst providing an effortless showering experience for the whole family.

Detail is fundamental with the Lumin8 Range to create a unique style with the highest quality. From the individual 'wrap around' chromed top caps, to the robust 8mm thick glass. From the pre-coated glass protection, to the elegant height of 1950mm. From the clear, low profile seals, to the bright silver profiles for a modern finish. Smooth running 'quick release' door system providing easy access for cleaning.



“ Good design is making something intelligible and memorable.
Great design is making something memorable and meaningful. ”

- Dieter Rams

One Door Quadrant

with sliding door



1200 x 900 Curved Quadrant

- One Door Offset Quadrant V8SQ91213S
- Roman Low Level Tray RLQ129R (Right Hand)
- Shower Basket RSB02

“An ideal solution for smaller bathrooms as it will sit beautifully in the corner of your bathroom, with an unobtrusive sliding door.”



900 x 900 Curved Quadrant

- One Door Quadrant V8SQ913S
- Roman Low Level Tray RLO90
- Shower Basket RSB02

GLASS THICKNESS
8
Millimetres

TOTAL HEIGHT
1950
Millimetres

REVERSIBLE

GLASS PROTECTION
ULTRA CARE
BY ROMAN

TRUELIFE
LIFETIME GUARANTEE

Features and Benefits:

- Chromed brass handle
- Bright silver frame
- 'Minimal' low profile seals
- Smooth running 'quick release' roller bearings
- 25mm vertical adjustment in each profile
- Tray Compatibility: Tray or straight to floor using Roman Shield Wetroom System



900 x 1200 Curved Quadrant

- One Door Offset Quadrant V8SQ91213S
- Roman Low Level Tray RLO129L (Left Hand)
- Shower Basket RSB02



Enclosure Size (mm)	Description	Adjustment (mm)	Door Aperture (mm)	Code	Cost ex VAT	Cost inc VAT
800 x 800	One Door Quadrant	750 - 775	425	V8SQ813S	£812.15	£974.58
900 x 900	One Door Quadrant	850 - 875	525	V8SQ913S	£812.15	£974.58
800 x 900	One Door Offset Quadrant	750 - 775 & 850 - 875	425	V8SQ8913S	£812.15	£974.58
800 x 1000	One Door Offset Quadrant	750 - 775 & 950 - 975	425	V8SQ81013S	£958.78	£1150.54
800 x 1200	One Door Offset Quadrant	750 - 775 & 1150 - 1175	425	V8SQ81213S	£1003.91	£1204.69
900 x 1200	One Door Offset Quadrant	850 - 875 & 1150 - 1175	525	V8SQ91213S	£1049.02	£1258.82

NB: Offset size enclosures - door always sits on curved/short edge of tray as illustrated.

Compatible Trays:	Page
Roman Anti-Slip Trays	122 - 123
Roman Infinity Trays	124 - 125
Roman Low Level Trays	128 - 129
Roman Shield System	147

Two Door Quadrant

sliding doors



900 X 1200 Offset Curved Quadrant

- Two Door Offset Quadrant V8Q91213S
- Roman Low Level Tray RLQ129R (Right Hand)
- Shower Basket RSB07

“The two sliding doors are an intelligent space saving tactic, whilst offering an indulgent showering area.”



GLASS THICKNESS
8
Millimètres

TOTAL HEIGHT
1950
Millimètres

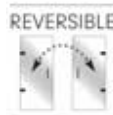

GLASS PROTECTION
ULTRA CARE
BY ROMAN

TRUELIFE
LIFETIME
GUARANTEE

Features and Benefits:

- Chromed brass handles
- Bright silver frame
- 'Minimal' low profile seals
- Smooth running 'quick release' roller bearings
- 25mm vertical adjustment in each profile
- Tray Compatibility: Tray or straight to floor using Roman Shield Wetroom System

900 x 900 Curved Quadrant

- Two Door Quadrant V8Q913S
- Roman Low Level Tray RLO9
- Shower Basket RSB02



Enclosure Size (mm)	Description	Adjustment (mm)	Aperture (mm)	Code	Cost ex VAT	Cost inc VAT
800 x 800	Two Door Quadrant	750 - 775	330	V8Q813S	£721.90	£866.28
800 x 900	Two Door Offset Quadrant	750 - 775 & 850 - 875	420	V8Q8913S	£721.90	£866.28
900 x 900	Two Door Quadrant	850 - 875	500	V8Q913S	£721.90	£866.28
800 x 1000	Two Door Offset Quadrant	750 - 775 & 950 - 975	420	V8Q81013S	£767.04	£920.45
800 x 1200	Two Door Offset Quadrant	750 - 775 & 1150 - 1175	420	V8Q81213S	£812.15	£974.58
900 x 1200	Two Door Offset Quadrant	850 - 875 & 1150 - 1175	510	V8Q91213S	£857.26	£1028.71

NB: Offset size enclosures - door always sits on curved/short edge of tray as illustrated.

Compatible Trays:	Page
Roman Anti-Slip Trays	122 - 123
Roman Infinity Trays	124 - 125
Roman Low Level Trays	128 - 129
Roman Shield System	147

Pivot Door

Outward Opening



1000 Alcove Fitting

- Pivot Door V8F1013S
- Roman Low Level Tray RLT100
- Shower Basket RSB06



1000 x 800 Corner Fitting

- 1000mm Pivot Door V8F1013S and 800mm Side Panel V8GL813S
- Roman Low Level RLT108
- Shower Basket RSB06



Features and Benefits:

- Chromed brass hinges
- Chromed brass handle
- Bright silver frame
- 'Minimal' low profile seals
- Pivot Door must be hinged from the wall
- 25mm vertical adjustment in each profile
- Tray Compatibility: Tray or straight to floor using Roman Shield Wetroom System

Corner or Alcove fitting

Size (mm)	Description	Adjustments (mm)	Aperture (mm)	Code	Cost ex VAT	Cost inc VAT
760	Pivot Door	700 - 750	465	V8F7613S	£569.62	£683.54
800	Pivot Door	740 - 790	505	V8F13S	£569.62	£683.54
900	Pivot Door	840 - 890	605	V8F913S	£614.76	£737.71
1000	Pivot Door	940 - 990	705	V8F1013S	£637.30	£764.76
700	Side Panel	640 - 690	-	V8GL713S	£323.98	£388.78
760	Side Panel	710 - 735	-	V8GL7613S	£351.52	£421.82
800	Side Panel	750 - 775	-	V8GL813S	£351.52	£421.82
900	Side Panel	850 - 875	-	V8GL913S	£383.00	£459.60
1000	Side Panel	950 - 975	-	V8GL1013S	£413.23	£495.88
200	In-Line Panel	+ 200mm to door sizes	-	V8HL213S	£209.86	£251.83
300	In-Line Panel	+ 300mm to door sizes	-	V8HL313S	£230.84	£277.01
1950 (height)	Extension Profile	-	-	VZEX2S	£67.68	£81.22

Compatible Trays:	Page
Roman Anti-Slip Trays	122 - 123
Roman Infinity Trays	124 - 125
Roman Low Level Trays	128 - 129
Roman Shield System	147

GLASS THICKNESS
8
Millimetres

TOTAL HEIGHT
1950
Millimetres

REVERSIBLE

GLASS PROTECTION
ULTRA CARE
BY ROMAN

TRUELIFE
LIFETIME GUARANTEE

Pivot Door

with In-Line Panel

Features and Benefits:

- Chromed brass hinges
- Chromed brass handle
- Bright silver frame
- 'Minimal' low profile seals
- Pivot Door must be hinged from the wall
- 25mm vertical adjustment in each profile
- Tray Compatibility: Tray or straight to floor using Roman Shield Wetroom System



1200 Alcove Fitting

- 1000mm Pivot Door V8F1013S with 200mm In-Line Panel V8HL213S
- Gloss Infinity Tray IAG128
- Shower Basket RSB06



1200 x 800 Corner Fitting

- 1000mm Pivot Door V8F1013S with 200mm In-Line Panel V8HL213S and 800mm Side Panel V8GL813S
- Gloss Infinity Tray IAG128
- Shower Basket RSB06

“ This outward opening door takes up minimal external space due to the positioning of the hinge point, meaning it protrudes less into the bathroom. ”

Corner or Alcove fitting

Size (mm)	Description	Adjustments (mm)	Aperture (mm)	Code	Cost ex VAT	Cost inc VAT
760	Pivot Door	700 - 750	465	V8F7613S	£569.62	£683.54
800	Pivot Door	740 - 790	505	V8F13S	£569.62	£683.54
900	Pivot Door	840 - 890	605	V8F913S	£614.76	£737.71
1000	Pivot Door	940 - 990	705	V8F1013S	£637.30	£764.76
200	In-Line Panel	+ 200mm to door sizes	-	V8HL213S	£209.86	£251.83
300	In-Line Panel	+ 300mm to door sizes	-	V8HL313S	£230.84	£277.01
700	Side Panel	640 - 690	-	V8GL713S	£323.98	£388.78
760	Side Panel	710 - 735	-	V8GL7613S	£351.52	£421.82
800	Side Panel	750 - 775	-	V8GL813S	£351.52	£421.82
900	Side Panel	850 - 875	-	V8GL913S	£383.00	£459.60
1000	Side Panel	950 - 975	-	V8GL1013S	£413.23	£495.88
1950 high	Extension Profile	-	-	VZEX2S	£67.68	£81.22

Compatible Trays:	Page
Roman Anti-Slip Trays	122 - 123
Roman Infinity Trays	124 - 125
Roman Low Level Trays	128 - 129
Roman Shield System	147

Inswing Door

with in-line panel

Outward Opening



1200 Alcove Fitting

- Door V8KH1213S
- 1200 x 800 Black Shimmer Infinity Tray IAG128B
- Shower Basket RSB02

“ This cleverly designed Inswing Door features a large opening without significant protrusion into the bathroom space. ”



1000x 800 Corner Fitting

- Door V8K1013S Side Panel V8GL813S
- 1000 x 800 Roman Low level Tray RLT108
- Shower Basket RSB02

GLASS THICKNESS
8
Millimetres

TOTAL HEIGHT
1950
Millimetres

REVERSIBLE

GLASS PROTECTION
ULTRA CARE
BY ROMAN

TRUELIFE

LIFETIME GUARANTEE

Features and Benefits:

- Chromed brass hinges
- Chromed brass handle
- Bright silver frame
- Inswing Door must be hinged from the wall
- Reversible for right or left hand fixing
- Tray Compatibility: Tray or straight to floor using Roman Shield Wetroom System



1200 Alcove Fitting

- Door V8KH1213S
- 1200 x 800 Black Shimmer Infinity Tray IAG128B
- Shower Basket RSB02



Size (mm)	Description	Adjustments (mm)	Aperture (mm)	Code	Cost ex VAT	Cost inc VAT
760	Inswing Door	700 - 750	540	V8K7613S	£774.21	£929.05
800	Inswing Door	740 - 790	580	V8K813S	£774.21	£929.05
900	Inswing Door	840 - 890	680	V8K913S	£825.47	£990.56
1000	Inswing Door	940 - 990	780	V8K1013S	£881.88	£1058.26
1200*	Inswing Door	1140 - 1190	580	V8KH1213S	£917.76	£1101.31
700	Side Panel	640 - 690	-	V8GL713S	£323.98	£388.78
760	Side Panel	710 - 735	-	V8GL7613S	£351.52	£421.82
800	Side Panel	750 - 775	-	V8GL813S	£351.52	£421.82
900	Side Panel	850 - 875	-	V8GL913S	£383.00	£459.60
1000	Side Panel	950 - 975	-	V8GL1013S	£413.23	£495.88
1950 high	Extension Profile	-	-	VZEX2S	£67.68	£81.22
200	In-Line Panel	+ 200mm to door sizes	-	V8HL213S	£209.86	£251.83
300	In-Line Panel	+ 300mm to door sizes	-	V8HL313S	£230.84	£277.01

In-Line Panels can be used with the Inswing Door

*Please note the 1200mm Inswing Door is a Door/In-Line Panel combination as image above

Compatible Trays:	Page
Roman Anti-Slip Trays	122 - 123
Roman Infinity Trays	124 - 125
Roman Low Level Trays	128 - 129
Roman Shield System	147

Level Access Sliding Door



1200 Alcove Fitting

- Sliding Door V8TLE1213SL (left hand)
- Roman Level Tray RLT128
- Shower Basket RSB07

Left hand opening - Closed position

“ Make your bathroom totally inclusive with this sliding door, as the bottom rail can be completely barrier free, creating true level access. ”

GLASS THICKNESS
8
Millimetres

TOTAL HEIGHT
1950
Millimetres

GLASS PROTECTION
ULTRA CARE
BY ROMAN

TRUELIFE
LIFETIME
GUARANTEE



Left hand opening - Open position

Features and Benefits:

- Frame: Silver
- Optional bottom rail
- Easy release door function
- Compatible with Lumin8 Side Panels
- Left or Right handing must be specified
- Tray compatibility: Tray or straight to floor using Roman Shield Wetroom System

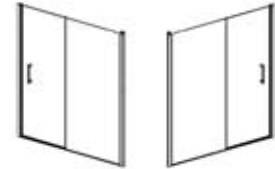

Left Hand

Right Hand

Corner or Alcove fitting

Please indicate left or right handing when ordering (add R or L to code)

Size (mm)	Description	Adjustments (mm)	Aperture (mm)	Code	Cost ex VAT	Cost inc VAT
1000	Level Access Sliding Door	940 - 990	360	V8TLE1013S	£636.80	£764.16
1100	Level Access Sliding Door	1040 - 1090	410	V8TLE1113S	£659.36	£791.23
1200	Level Access Sliding Door	1140 - 1190	460	V8TLE1213S	£681.91	£818.29
1400	Level Access Sliding Door	1340 - 1390	560	V8TLE1413S	£704.48	£845.38
1500	Level Access Sliding Door	1440 - 1490	610	V8TLE1513S	£711.99	£854.39
1700	Level Access Sliding Door	1640 - 1690	710	V8TLE1713S	£727.04	£872.45
700	Side Panel	640 - 690	-	V8GL713S	£323.98	£388.78
760	Side Panel	710 - 735	-	V8GL7613S	£351.52	£421.82
800	Side Panel	750 - 775	-	V8GL813S	£351.52	£421.82
900	Side Panel	850 - 875	-	V8GL913S	£383.00	£459.60
1000	Side Panel	950 - 975	-	V8GL1013S	£413.23	£495.88
1950 high	Extension Profile	-	-	VZEX2S	£67.68	£81.22

Compatible Trays:	Page
Roman Anti-Slip Trays	122 - 123
Roman Infinity Trays	124 - 125
Roman Low Level Trays	128 - 129
Roman Shield System	147

Sliding Door



1200 Alcove Fitting

- 1200mm Sliding Door V8T1213S
- Gloss Infinity Tray IAG128
- Shower Basket RSB06

“It exudes luxury with the effortless door action and generous door opening.”



1200 x 800 Corner Fitting

- 1200mm Sliding Door V8T1213S and 800mm Side Panel V8GL813S
- Gloss Infinity Tray IAG128
- Shower Basket RSB06

GLASS THICKNESS
8
Millimetres

TOTAL HEIGHT
1950
Millimetres



Features and Benefits:

- Chromed brass handle
- Bright silver frame
- Minimal low profile seals
- Smooth running 'quick release' roller bearings
- 25mm vertical adjustment in each profile
- Tray Compatibility: Tray or straight to floor using Roman Shield Wetroom System

Corner or Alcove fitting

Size (mm)	Description	Adjustments (mm)	Aperture (mm)	Code	Cost ex VAT	Cost inc VAT
1000	Sliding Door	940 - 990	360	V8T1013S	£575.27	£690.32
1100	Sliding Door	1040 - 1090	410	V8T1113S	£597.84	£717.41
1200	Sliding Door	1140 - 1190	460	V8T1213S	£620.38	£744.46
1400	Sliding Door	1340 - 1390	560	V8T1413S	£642.95	£771.54
1500	Sliding Door	1440 - 1490	610	V8T1513S	£650.47	£780.56
1700	Sliding Door	1640 - 1690	710	V8T1713S	£665.52	£798.62
700	Side Panel	640 - 690	-	V8GL713S	£323.98	£388.78
760	Side Panel	710 - 735	-	V8GL7613S	£351.52	£421.82
800	Side Panel	750 - 775	-	V8GL813S	£351.52	£421.82
900	Side Panel	850 - 875	-	V8GL913S	£383.00	£459.60
1000	Side Panel	950 - 975	-	V8GL1013S	£413.23	£495.88
1950 high	Extension Profile	-	-	VZEX2S	£67.68	£81.22
200	In-Line Panel	+ 200mm to door sizes	-	V8HL213S	£209.86	£251.83
300	In-Line Panel	+ 300mm to door sizes	-	V8HL313S	£230.84	£277.01

Compatible Trays:	Page
Roman Anti-Slip Trays	122 - 123
Roman Infinity Trays	124 - 125
Roman Low Level Trays	128 - 129
Roman Shield System	147

Bi-Fold Door

Inward Opening



800 Alcove Fitting

- Bi-Fold Door V8V13S
- Roman Low Level Tray RLT80
- Shower Basket RSB06

“Practical inward opening doors present an extremely flexible space saving solution”



GLASS THICKNESS
6
Millimetres

TOTAL HEIGHT
1950
Millimetres

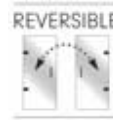

Features and Benefits:

- Chromed brass hinges
- Chromed brass handle
- Bright silver frame
- 25mm vertical adjustment in each profile
- Tray Compatibility: Tray or straight to floor using Roman Shield Wetroom System

800 x 800 Corner Fitting

- 800mm Bi-Fold Door V8V13S and 800mm Side Panel V8GL813S
- Roman Low Level Tray RLT80
- Shower Basket RSB06



Corner or Alcove fitting

Size (mm)	Description	Adjustments (mm)	Aperture (mm)	Code	Cost ex VAT	Cost inc VAT
760	Bi-Fold Door	700 - 750	460	V8V7613S	£620.38	£744.46
800	Bi-Fold Door	740 - 790	500	V8V13S	£620.38	£744.46
900	Bi-Fold Door	840 - 890	600	V8V913S	£671.14	£805.37
1000	Bi-Fold Door	940 - 990	700	V8V1013S	£727.55	£873.06
1200	Bi-Fold Door	1140 - 1190	900	V8V1213S	£750.12	£900.14
700	Side Panel	640 - 690	-	V8GL713S	£323.98	£388.78
760	Side Panel	710 - 735	-	V8GL7613S	£351.52	£421.82
800	Side Panel	750 - 775	-	V8GL813S	£351.52	£421.82
900	Side Panel	850 - 875	-	V8GL913S	£383.00	£459.60
1000	Side Panel	950 - 975	-	V8GL1013S	£413.23	£495.88
1950 high	Extension Profile	-	-	VZEX2S	£67.68	£81.22
200	In-Line Panel	+ 200mm to door sizes	-	V8HL213S	£209.86	£251.83
300	In-Line Panel	+ 300mm to door sizes	-	V8HL313S	£230.84	£277.01

N.B. 1000 and 1200 door options are one piece fully framed.

Compatible Trays:	Page
Roman Anti-Slip Trays	122 - 123
Roman Infinity Trays	124 - 125
Roman Low Level Trays	128 - 129
Roman Shield System	147

6mm

&
8mm

Embrace

Semi-Frameless Collection

Imaginative, urbane and innovative showering solutions designed to maximise space.

Our Embrace Collection brings together an innovative and stylish collection of shower enclosures and wetroom panels offering high performance and design benefits at an extremely competitive price. This exclusive range is available in an array of styles and shapes with bi-fold, hinged, quadrant, pivot, sliding doors and bath screens.

Specifications:

- All models feature exquisite chromed hardware and concealed fittings.
- All enclosures in the range are fully approved for use with power showers.
- Models that feature handle entry, present an elegant ergonomic bolt through handle which can be operated from inside and outside the unit.
- All Embrace enclosures and bath screens are supplied pre-coated with Roman Ultra Care - to aid glass protection from day one.

“ I strive for two things in design: simplicity and clarity. Great design is born of those two things. ”

- Lindon Leader

GLASS THICKNESS
6
Millimetres

TOTAL HEIGHT
1900
Millimetres

REVERSIBLE

GLASS PROTECTION
ULTRA CARE
by ROMAN

TRUELIFE

LIFETIME GUARANTEE

One Door Quadrant



900 x 1200 One Door Quadrant

- One Door Quadrant ESQ91213S
- Offset Roman Low Level Tray RLQ129R (right hand)

Features and Benefits:

- Silver frame
- Vertical adjustment: 25mm
- Smooth running roller bearing
- 'Quick release' system for easy cleaning
- Tray compatibility: 550mm radius

“A fusion of elegant styling and practical functionality”

Size (mm)	Description	Adjustments (mm)	Aperture (mm)	Code	Cost ex VAT	Cost inc VAT
800 x 800	One Door	760 - 785	410	ESQ813S	£721.40	£865.68
900 x 900	One Door	860 - 885	505	ESQ913S	£721.40	£865.68
800 x 900	One Door Offset	760 - 785 & 860 - 885	505	ESQ8913S	£721.40	£865.68
1000 x 800	One Door Offset	760 - 785 & 960 - 985	495	ESQ81013S	£861.37	£1033.64
800 x 1200	One Door Offset	760 - 785 & 1160 - 1185	470	ESQ81213S	£904.44	£1085.33
900 x 1200	One Door Offset	860 - 885 & 1160 - 1185	470	ESQ91213S	£947.50	£1137.00

Compatible Trays:	Page
Roman Anti-Slip Trays	122 - 123
Roman Infinity Trays	124 - 125
Roman Low Level Trays	128 - 129
Roman Shield System	147

Two Door Quadrant

with Sliding Doors



900 x 900 Two Door Quadrant

- Two Door Curved Quadrant EQ913S
- Roman Low Level Tray RLO90
- Shower Basket RSB05

“ Avoid bathrooms fittings with these central opening doors ”

Features and Benefits:

- Frame: Silver
- Vertical adjustment: 50mm
- Smooth running roller bearings
- 'Quick release' system for easy cleaning
- Tray compatibility: 550mm radius

Compatible Trays:	Page
Roman Anti-Slip Trays	122 - 123
Roman Infinity Trays	124 - 125
Roman Low Level Trays	128 - 129
Roman Shield System	147

Size (mm)	Description	Adjustments (mm)	Aperture (mm)	Code	Cost ex VAT	Cost inc VAT
800 x 800	Twin Door	760 - 785	315	EQ813S	£635.26	£762.31
900 x 900	Twin Door	860 - 885	485	EQ913S	£635.26	£762.31
760 x 900	Twin Door Offset	720 - 745 & 860 - 885	400	EQ76913S	£635.26	£762.31
1000 x 1000	Twin Door	960 - 985	485	EQ1013S	£721.40	£865.68
800 x 900	Twin Door Offset	760 - 785 & 860 - 885	405	EQ8913S	£635.26	£762.31
800 x 1000	Twin Door Offset	760 - 785 & 960 - 985	435	EQ81013S	£678.33	£814.00
800 x 1200	Twin Door Offset	760 - 785 & 1160 - 1185	440	EQ81213S	£721.40	£865.68
900 x 1200	Twin Door Offset	860 - 885 & 1160 - 1185	530	EQ91213S	£764.46	£917.35

Hinged Door

GLASS THICKNESS
8
Millimetres

TOTAL HEIGHT
1900
Millimetres

REVERSIBLE

GLASS PROTECTION
ULTRA CARE
BY ROMAN

TRULIFE

LIFETIME GUARANTEE

Outward Opening



900 Alcove Fitting

- Door EL913S
- 900 x 900mm Roman Low Level RLT9
- Shower Basket RSB05



900 x 900 Corner Fitting

- Hinged Door EL913S
- Frameless Side Panel EGL913S
- Roman Low Level Tray RLT90
- Shower Basket RSB01

“ Perfect door for out of true walls ”

Features and Benefits:

- Frame: Silver
- Vertical adjustment: 50mm
- Ball catch closing mechanism
- Outward opening doors must be hinged from the wall
- Tray compatibility: Tray or straight to floor using Roman Shield Wetroom System

Corner or Alcove fitting

Size (mm)	Adjustments (mm)	Aperture (mm)	Code	Cost ex VAT	Cost inc VAT
760	710 - 760	530	EL7613S	£609.37	£731.24
800	750 - 800	570	EL13S	£609.37	£731.24
900	850 - 900	670	EL913S	£657.62	£789.14
1000	950 - 1000	770	EL1013S	£677.12	£812.54

For the full range of compatible Embrace Frameless Side Panels and In-Line Panels see page 89

Compatible Trays:	Page
Roman Anti-Slip Trays	122 - 123
Roman Infinity Trays	124 - 125
Roman Low Level Trays	128 - 129
Roman Shield System	147

Level Access Sliding Door



Right Hand

1200 Alcove Fitting

- Sliding Door ETLE1213SR (right hand)
- Infinity Shower Tray IA128
- Shower Basket RSB07

“This enclosure is ideal for the whole family with its barrier free bottom rail options, spacious door opening and stylish ergonomic handle”

GLASS THICKNESS
6
Millimetres

TOTAL HEIGHT
1900
Millimetres

GLASS PROTECTION
ULTRA CARE
BY ROMAN

TRUELIFE
LIFETIME
GUARANTEE



Right Hand

1700 x 800 Corner Fitting

- Sliding Door ETLE1713SR (right hand)
- Side Panel EGL813S
- Infinity Shower Tray RST178
- Shower Basket RSB07

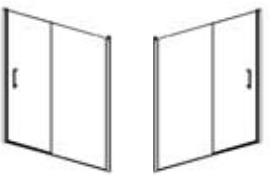

Left Hand Right Hand

Features and Benefits:

- Frame: Silver
- Optional bottom rail
- Easy release door function
- Compatible with Embrace Side Panels
- Left or Right handing must be specified
- Tray compatibility: Tray or straight to floor using Roman Shield Wetroom System

Corner or Alcove fitting

Please indicate left or right handing when ordering (add R or L to code)

Size (mm)	Adjustments (mm)	Aperture (mm)	Code	Cost ex VAT	Cost inc VAT
1000	950 - 1000	350	ETLE1013S	£556.81	£668.17
1100	1050 - 1100	400	ETLE1113S	£578.35	£694.02
1200	1150 - 1200	450	ETLE1213S	£599.88	£719.86
1400	1350 - 1400	550	ETLE1413S	£624.49	£749.39
1700	1650 - 1700	700	ETLE1713S	£647.05	£776.46

For the full range of compatible Embrace Frameless Side Panels and In-Line Panels see page 89

The minimalist nature of the product means if the shower head is directed at seal and component interfaces, some water may escape from the showering area. The product will perform as intended under normal showering conditions.

Compatible Trays:	Page
Roman Anti-Slip Trays	122 - 123
Roman Infinity Trays	124 - 125
Roman Low Level Trays	128 - 129
Roman Shield System	147

Sliding Door



1200 Corner Fitting

- Sliding Door ET1213S
- 900mm Frameless Side Panel EGL913S
- Roman Low Level Tray RLT129
- Shower Basket RSB03

Features and Benefits:

- Frame: Silver
- PVC vertical seals
- Adjustable smooth running bearings
- 'Quick release' mechanism
- Tray compatibility: Tray or straight to floor using Roman Shield Wetroom System

Compatible Trays:	Page
Roman Anti-Slip Trays	122 - 123
Roman Infinity Trays	124 - 125
Roman Low Level Trays	128 - 129
Roman Shield System	147

“Sliding doors are a key space saving feature”

Corner or Alcove fitting

Size (mm)	Adjustment (mm)	Aperture (mm)	Code	Cost ex VAT	Cost inc VAT
1000	950 - 1000	350	ET1013S	£495.29	£594.35
1100	1050 - 1100	400	ET1113S	£516.82	£620.18
1200	1150 - 1200	450	ET1213S	£538.35	£646.02
1400	1350 - 1400	550	ET1413S	£562.97	£675.56
1700	1650 - 1700	700	ET1713S	£585.52	£702.62

For the full range of compatible Embrace Frameless Side Panels and In-Line Panels see page 89

Pivot Door

GLASS THICKNESS 6 Millimetres	TOTAL HEIGHT 1900 Millimetres	REVERSIBLE 	GLASS PROTECTION ULTRA CARE by ROMAN	TRUETIME LIFETIME GUARANTEE
--------------------------------------------	--------------------------------------------	----------------	---------------------------------------------------	------------------------------------

Outward Opening



900 x 900 Corner Fitting

- Pivot Door EF913S
- Side Panel EGL913S
- Roman Low Level Tray RLT90
- Shower Basket RSB06

Features and Benefits:

- Frame: Silver
- Magnetic door closing
- PVC vertical seals
- Reduced opening into room due to hinge position
- Outward opening doors must be hinged from the wall
- Tray compatibility: Tray or straight to floor using Roman Shield Wetroom System

“Ideal space saving solution as the position of the hinge point means less protrusion into the bathroom”

Compatible Trays:	Page
Roman Anti-Slip Trays	122 - 123
Roman Infinity Trays	124 - 125
Roman Low Level Trays	128 - 129
Roman Shield System	147

Size (mm)	Adjustment (mm)	Aperture (mm)	Code	Cost ex VAT	Cost inc VAT
760	715 - 760	455	EF7613S	£490.24	£588.29
800	755 - 800	495	EF13S	£490.24	£588.29
900	855 - 900	595	EF913S	£530.07	£636.08

For the full range of compatible Embrace Frameless Side Panels and In-Line Panels see page 89

Embrace

Bi-Fold Door

GLASS THICKNESS
6
Millimetres

TOTAL HEIGHT
1900
Millimetres

REVERSIBLE

GLASS PROTECTION
ULTRA CARE
BY ROMAN

TRUELIFE
LIFETIME GUARANTEE

Inward Opening

Features and Benefits:

- Frame: Silver
- Smooth running roller bearings
- Tray compatibility: Tray or straight to floor using Roman Shield Wetroom System

“The in-fold design of the Embrace Bi-Fold Door creates more useable space and minimal bathroom intrusion.”



1200 Alcove Fitting

- Bi-Fold Door EV1213S
- Roman Low Level Tray RLT129
- Shower Basket RSB02



900 x 900 Corner Fitting

- Bi-Fold Door EV913S
- Side Panel EGL913S
- Roman Low Level Tray RLT90
- Shower Basket RSB05

Size (mm)	Adjustments (mm)	Aperture (mm)	Code	Cost ex VAT	Cost inc VAT
760	715 - 760	470	EV7613S	£540.51	£648.61
800	755 - 800	510	EV13S	£540.51	£648.61
900	855 - 900	610	EV913S	£589.82	£707.78
1000	955 - 1000	710	EV1013S	£639.12	£766.94
1200	1155 - 1200	910	EV1213S	£659.03	£790.84

Compatible Trays:	Page
Roman Anti-Slip Trays	122 - 123
Roman Infinity Trays	124 - 125
Roman Low Level Trays	128 - 129
Roman Shield System	147

For the full range of compatible Embrace Frameless Side Panels and In-Line Panels see page 89



Side Panels

In-Line Panels

Neo-Angle Panels

Features and Benefits:

- Frame: Silver
- Compatible with Embrace corner posts and extension profiles
- In-Line and Neo-Angle Panels are 8mm thick glass offering extra rigidity



Side Panel

- Embrace 900mm Pivot Door EF913S
- 900mm Side Panel EGL913S



In-Line Panel

- Embrace 760mm Bi-Fold Door EV7613S
- 400mm In-Line Panel EHL413S



Neo Panel Pack

- Embrace 760mm Bi-Fold Door EV7613S
- 1200 x 900mm Neo Angle Pack EP1213S

For Neo-Angle tray information see page 126

Size (mm)	Description	Adjustment (mm)	Glass Thickness (mm)	Product Suitability Code	Code	Cost ex VAT	Cost inc VAT
700	Side Panel	660 - 685	6	EF/EL/EV/ET/ETLE	EGL713S	£288.25	£345.90
760	Side Panel	720 - 745	6	EF/EL/EV/ET/ETLE	EGL7613S	£288.25	£345.90
800	Side Panel	760 - 785	6	EF/EL/EV/ET/ETLE	EGL813S	£288.25	£345.90
900	Side Panel	860 - 885	6	EF/EL/EV/ET/ETLE	EGL913S	£313.62	£376.34
1000	Side Panel	960 - 985	6	EF/EL/EV/ET/ETLE	EGL1013S	£339.81	£407.77
200	In-Line Panel	950 - 1000	8	EF76/EV76	EHL213S	£284.28	£341.14
300	In-Line Panel	1050 - 1100	8	EF76/EV76/EL76	EHL313S	£284.28	£341.14
400	In-Line Panel	1150 - 1200	8	EF/EV/EL	EHL413S	£284.28	£341.14
800	In-Line Panel	1532 - 1582	8	EV9/EL9/EF9	EHL813S	£314.37	£377.24
900 x 900	Neo Panel Pack	17 each side	8	EV76/EF76	EP913S*	£470.09	£564.11
1200 x 900	Neo Panel Pack	17 each side	8	EV76/EF76	EP1213S*	£503.33	£604.00
1900 high	Extension profile	35 (extra)		EF/EV/EL/ET/E1T	EZEXS	£61.38	£73.66

*For use with Bi-fold and Pivot Doors
Please note that other configurations are available for In-Line Panels.

Contact Customer Services 01325 328035

Compatible Trays:	Page
Roman Anti-Slip Trays	122 - 123
Roman Infinity Trays	124 - 125
Roman Low Level Trays	128 - 129
Roman Shield System	147

6mm
&
4mm

- Sliding Door Enclosures
- Bi-Fold Doors
- Side and In-Line Panels

Collage

Framed Collection

Affordable showering with uncompromised quality

Our Collage collection delivers a sense of subtle luxury to your bathroom, encompassing a shower concept to meet all your requirements - without compromising on quality. Innovative and affordable product designs meet contemporary and minimal styling.

“Success isn't something you achieve
by accident, but rather by design”

- David H. Murdoch

Bi-fold Door

GLASS THICKNESS
4
Millimetres

TOTAL HEIGHT
1900
Millimetres

REVERSIBLE

GLASS PROTECTION
ULTRA CARE
BY ROMAN

TRUETIME
LIFETIME GUARANTEE

Inward Opening



1200 x 700 Corner Fitting

- Bi-Fold Door C2V1213S
- Side Panel C2GM713S
- Roman Low Level Tray RLT127
- Shower Basket RSB06



1200 Alcove Fitting

- Bi-Fold Door C2V1213S
- Roman Low Level Tray RLT127
- Shower Basket RSB06

Features and Benefits:

- Frame: Silver
- Fully framed door with magnetic closing mechanism and cushioned seals
- Full length integral handle on inside and outside of door
- Precision roller bearing mechanism for smooth sliding action
- Tray compatibility: Tray or straight to floor using Roman Shield Wetroom System

Compatible Trays:	Page
Roman Anti-Slip Trays	122 - 123
Roman Infinity Trays	124 - 125
Roman Low Level Trays	128 - 129
Roman Shield System	147

“ Precision roller bearings
for smooth sliding action ”

Size (mm)	Adjustment (mm)	Aperture (mm)	Code	Cost ex VAT	Cost inc VAT
700	650 - 705	470	C2V713S	£430.89	£517.07
760	680 - 735	500	C2V7613S	£430.89	£517.07
760/800	740 - 795	560	C2V13S	£430.89	£517.07
900	830 - 885	650	C2V913S	£474.00	£568.80
1000	940 - 995	760	C2V1013S	£517.07	£620.48
1200	1145 - 1200	965	C2V1213S	£560.16	£672.19

For the full range of compatible Collage Side Panels, In-Line Panels and Extension profiles see page 93

GLASS THICKNESS
4
Millimetres

TOTAL HEIGHT
1900
Millimetres

REVERSIBLE

GLASS PROTECTION
ULTRA CARE
BY ROMAN

TRUELIFE
LIFETIME GUARANTEE

Sliding Door



1200 x 700 Corner Fitting

- Sliding Door C2T1213S
- Side Panel C2GM713S
- Roman Low Level Tray RLT127
- Shower Basket RSB01

Features and Benefits:

- Frame: Silver
- Fully framed door with magnetic closing mechanism and cushioned seals
- Full length integral handle on inside and outside of door
- Precision roller bearing mechanism for smooth sliding action
- Tray compatibility: Tray or straight to floor using Roman Shield Wetroom System

“The Collage sliding doors are perfect for confined or awkward spaces as they do not protrude out into the bathroom.”

Size (mm)	Adjustment (mm)	Aperture (mm)	Code	Cost ex VAT	Cost inc VAT
1200	1140 - 1195	450	C2T1213S	£512.72	£615.26

Compatible Trays:	Page
Roman Anti-Slip Trays	122 - 123
Roman Infinity Trays	124 - 125
Roman Low Level Trays	128 - 129
Roman Shield System	147

For the full range of compatible Collage Side Panels, In-Line Panels and Extension profiles see page 93

Side Panels

In-Line Panels

GLASS THICKNESS
6
Millimetres

TOTAL HEIGHT
1900
Millimetres

REVERSIBLE

GLASS PROTECTION
ULTRA CARE
BY ROMAN

TRUELIFE

LIFETIME GUARANTEE

Features and Benefits:

- Frame: Silver
- All Collage Doors are suitable for all Collage Side Panels and In-Line Panels
- Outward opening doors must be hinged from the wall



- Collage 760/800mm Bi-Fold Door C2V13S
- 400mm Frameless In-Line Panel C2HM413S
- 700mm Frameless Side Panel C2GM13S
- Shower Basket RSB03



- Sliding Door C2T1213S
- Side Panel C2GM13S
- Shower Basket RSB01

Size (mm)	Panel Type	Adjustments (mm)	To suit tray size	Door compatibility code	Code	Cost ex VAT	Cost inc VAT
700	Side Panel	630 - 685	700mm side	C2V/C2T	C2GM713S	£247.06	£296.47
760	Side Panel	690 - 745	760mm side	C2V/C2T	C2GM7613S	£247.06	£296.47
800	Side Panel	730 - 785	800mm side	C2V/C2T	C2GM13S	£247.06	£296.47
900	Side Panel	830 - 885	900mm side	C2V/C2T	C2GM913S	£271.22	£325.46
1000	Side Panel	930 - 985	1000mm side	C2V/C2T	C2GM1013S	£296.15	£355.38
1200	Side Panel	1130 - 1185	1200mm side	C2V/C2T	C2GM1213S	£328.11	£393.73
200	In-Line Panel	940 - 1040	1000mm side	C2V7	C2HM213S	£247.06	£296.47
300	In-Line Panel	1030 - 1130	1100mm side	C2V76	C2HM313S	£247.06	£296.47
400	In-Line Panel	1145 - 1245	1200mm side	C2V	C2HM413S	£247.06	£296.47
-	Extension Profile	35mm extra	N/A	N/A	C2ZEXS	£53.04	£63.65

Please note that other configurations are available for In-Line Panels. Contact Customer Service 01325 328033.

10mm
&
8mm

Wetroom Panels

Wetroom Ranges

Straight Panels:

- Select
- Liberty
- Innov8
- Embrace
- Collage

Curved Panels:

- Lumin8
- Embrace

For Roman Shield Wetroom System
see page 147

Wetroom shower panels are a more open alternative to a shower enclosure, which usually consist of just one glass panel. This can either be positioned in a corner or on a straight wall. Wetroom panels can be installed onto a shower tray, or installed straight down to floor.

The Roman Wetroom Collection offers a variety of heights, shapes, glass thicknesses and price points – with a multitude of design options to choose from and now you can choose between chrome or black finish.

“Perfection is achieved not when there is nothing more to add, but when there is nothing left to take away.”

- Antoine de Saint-Exupery



Select Wetroom Solutions

Straight Panels

The perfect way to create a wetroom - tailored to your own style

Roman's Select Collection features our Wetroom Panel options, which can be fitted to our low level shower trays or straight to floor to create a true wetroom. We present a number of panel sizes and options, to help you create your perfect bathroom sanctuary. Included are the various configurations that are available to suit you and your bathroom.

All Panels are 2000mm high and available in either 8mm glass thickness or 10mm glass thickness and either chrome or matt black finish



1700 x 900 3 sided wetroom (silver chrome finish)

- x2 900mm Corner Panels V10SP913S
- 1000mm Glass to Glass Panel V10FP1013S
- 300mm Pivoting Deflector Panel V10SPM313S
- Brace Bars LBBK4590SQ
- Black Shower Basket RSB01

Selecting your configuration

Select the size of panel you require in either 8 or 10mm glass thickness; select your colour; select your configuration; select between a fixed or pivoting deflector panel; and select your desired bracing bars.

Straight Panels



1700 x 900 3 sided wetroom (matt black finish)

- x2 900mm Corner Panels V10SP913B
- 1000mm Glass to Glass Panel V10FP1013B
- 300mm Pivoting Deflector Panel V10SPM313B
- Brace Bars LBBK4590SQB
- Black Shower Basket RSB01B

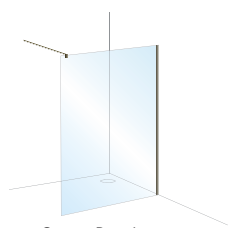

- Corner Panel
- Low Level Brace kit

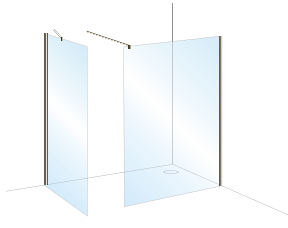

- x2 Corner Panels
- x2 Low Level Brace kits

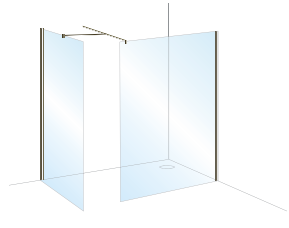

- x2 Corner Panels
- Low Level Brace kit
- Side Panel Brace kit

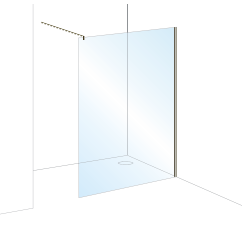

- Corner Panel (in Alcove)
- Low Level Brace kit

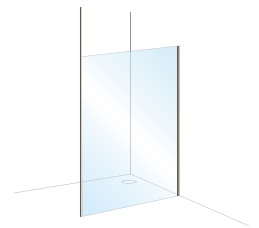

- Corner Panel
- Floor to Ceiling Brace kit

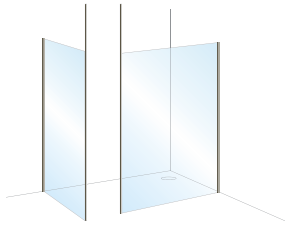

- x2 Corner Panels
- x2 Floor to Ceiling Brace kit

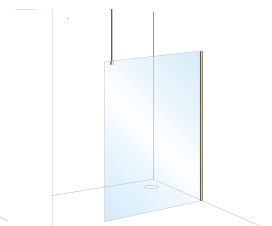

- Corner Panel
- Ceiling Brace kit

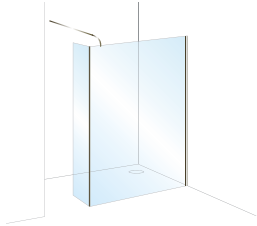

- Corner Panel
- Pivoting Deflector Panel
- High Level Brace kit

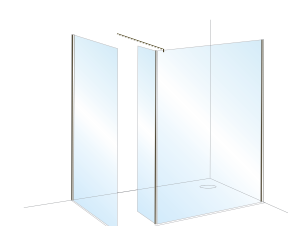

- x2 Corner Panels
- Fixed Deflector
- Low Level Brace kit

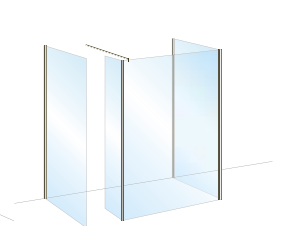

- x2 Corner Panel
- Glass to Glass Panel
- Deflector Panel
- Low Level Brace kit

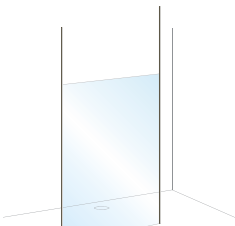

- Linear Panel
- x2 Floor to Ceiling Brace kit

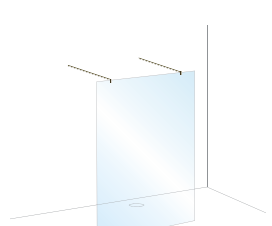

- Linear Panel
- x2 Low Level Brace kit

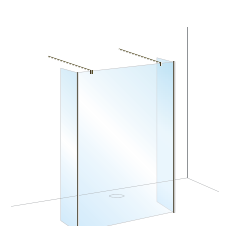

- Linear Panel
- x2 Pivoting deflector panels
- x2 Low Level Brace kit

This is just a selection of configurations which can be created using either 8mm or 10mm Select glass panels.

Please see pages 99 - 103 for more information



Corner Panel
Fixed Deflector Panel
Low Level Brace



Corner Panel x2
Fixed Deflector Panel
Low Level Brace with
Side Panel Brace



Corner Panels
Floor to Ceiling Brace



Corner Panel
Low Level Brace



Linear Panel
Pivoting Deflector Panels x2



Corner Panel x2
Glass to Glass Panel
Pivoting Deflector Panel
Low Level Brace x2



Select Wetroom Solutions

Straight Panels

All panels are 2000mm in height

No brace bars included - please see pages 100 - 101 to select your style of Bracing required.

- Due to the nature of the product water integrity cannot be guaranteed - please consult your installer

8mm Glass

10mm Glass

Description	8mm Glass				10mm Glass					
	Actual Width (mm)	Order Code Chrome finish	Order Code Black finish	Cost ex VAT	Cost inc VAT	Actual Width (mm)	Order Code Chrome finish	Order Code Black finish	Cost ex VAT	Cost inc VAT
Corner Panel (includes wall fixing kit allowing +/- 7.5mm of vertical adjustment). For brace bar options see pages 100-101										
400 Corner Panel	365mm	V8SP413S	V8SP413B	£203.06	£243.67	350mm	V10SP413S	V10SP413B	£209.82	£251.78
500 Corner Panel	465mm	V8SP513S	V8SP513B	£212.28	£254.74	450mm	V10SP513S	V10SP513B	£227.66	£273.19
600 Corner Panel	565mm	V8SP613S	V8SP613B	£221.49	£265.79	550mm	V10SP613S	V10SP613B	£252.26	£302.71
700 Corner Panel	665mm	V8SP713S	V8SP713B	£230.72	£276.86	650mm	V10SP713S	V10SP713B	£264.56	£317.47
760 Corner Panel	725mm	V8SP7613S	V8SP7613B	£236.88	£284.26	710mm	V10SP7613S	V10SP7613B	£273.79	£328.55
800 Corner Panel	765mm	V8SP813S	V8SP813B	£239.95	£287.94	750mm	V10SP813S	V10SP813B	£279.94	£335.93
900 Corner Panel	865mm	V8SP913S	V8SP913B	£249.18	£299.02	850mm	V10SP913S	V10SP913B	£292.25	£350.70
1000 Corner Panel	965mm	V8SP1013S	V8SP1013B	£261.49	£313.79	950mm	V10SP1013S	V10SP1013B	£307.63	£369.16
1100 Corner Panel	1065mm	V8SP1113S	V8SP1113B	£278.71	£334.45	1050mm	V10SP1113S	V10SP1113B	£327.94	£393.52
1200 Corner Panel	1165mm	V8SP1213S	V8SP1213B	£295.94	£355.13	1150mm	V10SP1213S	V10SP1213B	£348.24	£417.89
1400 Corner Panel	1365mm	V8SP1413S	V8SP1413B	£313.17	£375.80	1350mm	V10SP1413S	V10SP1413B	£368.54	£442.25
Deflector Panel (includes fixed or pivoting corner fixing kit) see page 102 for more details. For brace bar options see pages 100-101										
200 Fixed Deflector Panel	226mm	V8SPL213S	V8SPL213B	£150.47	£180.56	226mm	V10SPL213S	V10SPL213B	£178.43	£214.12
200 Pivoting Deflector Panel	243mm	V8SPM213S	V8SPM213B	£193.81	£232.57	243mm	V10SPM213S	V10SPM213B	£230.64	£276.77
300 Pivoting Deflector Panel	343mm	V8SPM313S	V8SPM313B	£199.20	£239.04	343mm	V10SPM313S	V10SPM313B	£237.05	£284.46
400 Pivoting Deflector Panel	443mm	V8SPM413S	V8SPM413B	£204.57	£245.48	443mm	V10SPM413S	V10SPM413B	£243.45	£292.14
Linear Panel (includes freestanding floor fixing kit). For brace bar options see pages 100-101										
1000 Linear Panel	955mm	V8LP1013S	V8LP1013B	£261.49	£313.79	940mm	V10LP1013S	V10LP1013B	£307.63	£369.16
1100 Linear Panel	1055mm	V8LP1113S	V8LP1113B	£278.71	£334.45	1040mm	V10LP1113S	V10LP1113B	£327.94	£393.53
1200 Linear Panel	1155mm	V8LP1213S	V8LP1213B	£295.94	£355.13	1140mm	V10LP1213S	V10LP1213B	£348.24	£417.89
1400 Linear Panel	1355mm	V8LP1413S	V8LP1413B	£313.17	£375.80	1340mm	V10LP1413S	V10LP1413B	£368.54	£442.25
Glass to Glass Panel (includes fixing kit). For brace bar options see pages 100										
600 Glass to Glass Panel	567mm	V8FP613S	V8FP613B	£221.49	£265.79	556mm	V10FP613S	V10FP613B	£252.26	£302.71
700 Glass to Glass Panel	667mm	V8FP713S	V8FP713B	£230.72	£276.86	656mm	V10FP713S	V10FP713B	£264.56	£317.47
760 Glass to Glass Panel	727mm	V8FP7613S	V8FP7613B	£236.88	£284.26	716mm	V10FP7613S	V10FP7613B	£273.79	£328.55
800 Glass to Glass Panel	767mm	V8FP813S	V8FP813B	£239.95	£287.94	756mm	V10FP813S	V10FP813B	£279.94	£335.93
900 Glass to Glass Panel	867mm	V8FP913S	V8FP913B	£249.18	£299.02	856mm	V10FP913S	V10FP913B	£292.25	£350.70
1000 Glass to Glass Panel	967mm	V8FP1013S	V8FP1013B	£261.49	£313.79	956mm	V10FP1013S	V10FP1013B	£307.63	£369.16
1100 Glass to Glass Panel	1067mm	V8FP1113S	V8FP1113B	£278.71	£334.45	1056mm	V10FP1113S	V10FP1113B	£327.94	£393.53
1200 Glass to Glass Panel	1167mm	V8FP1213S	V8FP1213B	£295.94	£355.13	1156mm	V10FP1213S	V10FP1213B	£348.24	£417.89

Compatible Trays:	Page
Roman Anti-Slip Trays	122 - 123
Roman Infinity Trays	124 - 125
Roman Low Level Trays	128 - 129
Roman Shield System	147

Brace Bars

Straight Panels

Roman provides a number of different styles of bracing bars, which can be used with 8mm and 10mm glass thicknesses. We offer all configurations that may be required and they can be cut and trimmed to the size required during installation to allow maximum flexibility and use of space. Bracing kits are used to provide added support for the glass and ensure that it is securely fitted in place.

We have something to suit the enclosure style, your bathroom area and your preference, to present the highest level of stability.

Our Square brace bars are now available in Black or Chrome



Round Brace Bars



- Key:
1. Low Level Brace Kit *
 2. Side Panel Brace Kit (for use with LBBK4590*)
 3. Ceiling Brace Kit
 4. Floor to Ceiling Brace Kit
 5. High Level Brace Kit
 6. Low Level Brace Kit (90° only)

Description	For use with glass thickness	Size (mm) Max	Adjustment (mm) Min	Code Chrome finish	Cost ex VAT	Cost inc VAT
Low Level Brace Kit*	6mm / 8mm / 10mm	1030	Cut to suit	LBBK4590	£101.97	£122.36
Side Panel Brace Kit (use with LBBK4590)	6mm / 8mm / 10mm	1000	Cut to suit	LBBKT90	£101.97	£122.36
Ceiling Brace Kit	6mm / 8mm / 10mm	1030	Cut to suit	LBBKC50	£98.33	£118.00
Floor to Ceiling Brace Kit	8mm	2700 high	Cut to suit	RF2C8KIT	£109.84	£131.81
High Level Brace Kit	6mm / 8mm / 10mm	1135	Cut to suit	FBBK10	£109.84	£131.81
Low Level Brace Kit (90° only)	6mm / 8mm / 10mm	1135	Cut to suit	LBBK90	£79.13	£94.96

*For use straight back to wall or can be cut to 45° if required for corner fixing as illustrated in 1 and 1(b).
N.B. Adjustments are measured from the wall to the inside of the glass.



Square Brace Bars



Key:

1. Low Level Brace Kit *
2. Side Panel Brace Kit (for use with LBBK4590SQ*)
3. Ceiling Brace Kit
4. Floor to Ceiling Brace Kit

Description	For use with glass thickness	Colour	Size (mm) Max	Adjustment (mm) Min	Code	Cost ex VAT	Cost inc VAT
Low Level Brace Kit*	6mm / 8mm / 10mm	Chrome	1030	Cut to suit	LBBK4590SQ	£101.97	£122.36
Side Panel Brace Kit (use with LBBK4590SQ)	6mm / 8mm / 10mm	Chrome	1000	Cut to suit	LBBKT90SQ	£101.97	£122.36
Ceiling Brace Kit	6mm / 8mm / 10mm	Chrome	1030	Cut to suit	LBBKC50SQ	£98.33	£118.00
Floor to Ceiling Brace Kit	8mm	Chrome	2700 high	Cut to suit	RF2C8KITSQ	£109.83	£131.80
Low Level Brace Kit*	6mm / 8mm / 10mm	Black	1030	Cut to suit	LBBK4590SQB	£112.18	£134.62
Side Panel Brace Kit (use with LBBK4590SQ)	6mm / 8mm / 10mm	Black	1000	Cut to suit	LBBKT90SQB	£112.18	£134.62
Ceiling Brace Kit	6mm / 8mm / 10mm	Black	1030	Cut to suit	LBBKC50SQB	£112.18	£134.62
Floor to Ceiling Brace Kit	8mm	Black	2700 high	Cut to suit	RF2C8KITSQB	£120.81	£144.97

*For use straight back to wall or can be cut to 45° if required for corner fixing as illustrated in 1 and 1(b).
N.B. Adjustments are measured from the wall to the inside of the glass.

Deflector Panels

Fixed or Pivoting

Straight Panels



1400 x 900 Corner Fitting

- Corner Panel V8SP1413S (x2)
- Pivoting Deflector Panel V8SPM213S
- Brace Bars LBBK4590SQ, LBBKT90SQ
- Infinity Shower Tray IA149
- Shower Basket RSB01



Pivoting Panel

Features and Benefits:

- Retro Fitable
- Improve water integrity
- Rotates through 180°
- Smooth pivot motion
- Stows when not in use to improve access



Adjustable Foot

Due to the nature of the product water integrity cannot be guaranteed - please consult your installer



Fixed Panel

Features and Benefits:

- Retro Fitable
- Improve water integrity
- Panel Foot adjusts from 4mm to 29mm to accommodate high and low level trays
- Panel foot is chromed brass with soft rubber base
- Panel foot is cut down on site to suit the shower tray

A close-up, profile view of a woman's face and hands in a shower. She is smiling and looking upwards as water sprays onto her face and hands. The background is a light blue wall with water droplets.

“ Water is the driving force of all nature ”
- Leonardo di Vinci

Wetrooms

Liberty

Black Grid

Wetroom Panels with Matt Black finish

Straight Panels



1600 x 800 - Corner Fitting

- Corner Panel KLCP9GPB
- Corner Panel KLCP8GPB
- Brace Bars LBBKC50SQB x 2
- Infinity Shower Tray IA168

“The best way to predict the future is to create it”

- Abraham Lincoln



GLASS THICKNESS
10
Millimetres

TOTAL HEIGHT
2000
Millimetres

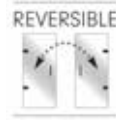

Features and Benefits:

- Frame: Matt Black
- Vertical adjustment: $\pm 7.5\text{mm}$
- Tray compatibility: Tray or straight to floor using Roman Shield Wetroom System
- Unique sealing tape system technology to reduce the need for silicone
- Due to the nature of the product water integrity cannot be guaranteed - please consult your installer
- Glass filled paint fired into the glass during toughening
- Silicone Free Wall Fixing

1600 x 800 Corner Fitting

- Corner Panel KLCP9GPB
- Corner Panel KLCP8GPB
- Pivoting Deflector Panel KLSPM3GPB
- Brace Bar LBBK50SQB
- Infinity Shower Tray IA168



Panels

Size (mm)	Description	Adjustment (mm)	Code	Cost ex VAT	Cost inc VAT
757	Black Grid Corner Panel	$\pm 7.5\text{mm}$	KLCP8GPB	£526.55	£631.86
857	Black Grid Corner Panel	$\pm 7.5\text{mm}$	KLCP9GPB	£560.89	£673.07
957	Black Grid Corner Panel	$\pm 7.5\text{mm}$	KLCP10GPB	£595.23	£714.28
1057	Black Grid Corner Panel	$\pm 7.5\text{mm}$	KLCP11GPB	£629.57	£755.48
1157	Black Grid Corner Panel	$\pm 7.5\text{mm}$	KLCP12GPB	£663.91	£796.69
243	Black Grid Pivoting Deflector Panel		KLSPM3GPB	£312.43	£374.92

Brace Bars

Description	Size (mm)		Adjustment (mm)	Code	Cost ex VAT	Cost inc VAT
	Max	Min				
Low Level Brace Kit*	1030	Cut to suit		LBBK4590SQB	£112.18	£134.62
Side Panel Brace Kit (use with LBBK4590SQ)	1000	Cut to suit		LBBKT90SQB	£112.18	£134.62
Ceiling Brace Kit	1030	Cut to suit		LBBK50SQB	£112.18	£134.62
Floor to Ceiling Brace Kit	2700 high	Cut to suit		RF2C8KITSQB	£120.81	£144.97

Compatible Trays:	Page
Roman Anti-Slip Trays	122 - 123
Roman Infinity Trays	124 - 125
Roman Low Level Trays	128 - 129
Roman Shield System	147

Liberty

Wetroom Panels

with Matt Black finish and clear glass

Straight Panels



1600 x 800 Tray

- Corner Panel KLCP813B
- Pivoting Deflector Panel KLSPM313B
- Brace Bar LBBKC50SOB
- Infinity Shower Tray IA168

GLASS THICKNESS
10
Millimetres

TOTAL HEIGHT
2000
Millimetres

REVERSIBLE

GLASS PROTECTION
ULTRA CARE
- ROMAN

TRUELIFE
LIFETIME
GUARANTEE

Features and Benefits:

- Frame: Matt Black
- Vertical adjustment: ± 7.5 mm
- Tray compatibility: Tray or straight to floor using Roman Shield Wetroom System
- Unique sealing tape system technology to reduce the need for silicone
- Due to the nature of the product water integrity cannot be guaranteed - please consult your installer
- Silicone Free Wall Fixing



1200 Corner Panel

- Corner Panel KLCP1213B
- Brace Bar LBBK4590SQB

Panels

Size (mm)	Description	Adjustment (mm)	Code	Cost ex VAT	Cost inc VAT
757	Clear Glass Corner Panel	± 7.5 mm	KLCP813B	£389.19	£467.03
857	Clear Glass Corner Panel	± 7.5 mm	KLCP913B	£412.08	£494.50
957	Clear Glass Corner Panel	± 7.5 mm	KLCP1013B	£434.98	£521.98
1057	Clear Glass Corner Panel	± 7.5 mm	KLCP1113B	£457.87	£549.44
1157	Clear Glass Corner Panel	± 7.5 mm	KLCP1213B	£480.76	£576.91
243	Clear Glass Pivoting Deflector Panel		KLSPM313B	£240.33	£288.406

Brace Bars

Description	Size (mm)		Adjustment (mm)	Code	Cost ex VAT	Cost inc VAT
	Max	Min				
Low Level Brace Kit*	1030		Cut to suit	LBBK4590SQB	£112.18	£134.62
Side Panel Brace Kit (use with LBBK4590SQ)	1000		Cut to suit	LBBKT90SQB	£112.18	£134.62
Ceiling Brace Kit	1030		Cut to suit	LBBKC50SQB	£112.18	£134.62
Floor to Ceiling Brace Kit	2700 high		Cut to suit	RF2C8KITSQB	£120.81	£144.97

Compatible Trays:	Page
Roman Anti-Slip Trays	122 - 123
Roman Infinity Trays	124 - 125
Roman Low Level Trays	128 - 129
Roman Shield System	147

Folding Wetroom Panels

Straight Panels



1000 Wetroom Panel
• N2VC1013S

“This innovative wetroom panel creates a large and open space to enter the showering area.”



Folded position

GLASS THICKNESS
8
Millimetres

TOTAL HEIGHT
1967
Millimetres

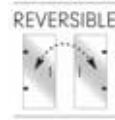

GLASS PROTECTION
ULTRA CARE
BY ROMAN

TRUELIFE
LIFETIME
GUARANTEE

Features and Benefits:

- Frameless inward folding panels with 180° pivoting action
- Bright silver profile
- Chromed brass hinges
- Chromed brass top caps
- Clear seals
- No top rail
- Elimination of the bottom rail creating level access entry
- Due to the nature of the product water integrity cannot be guaranteed - please consult your installer

Folding positions:



Showering Area

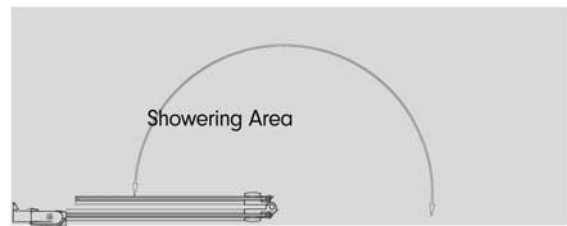

Showering Area



Showering Area



Showering Area

Panel Size (mm)	Adjustment (mm)	Code	Cost ex VAT	Cost inc VAT
800	760 - 780	N2VC813S	£638.28	£765.94
900	860 - 880	N2VC913S	£685.75	£822.90
1000	960 - 980	N2VC1013S	£733.23	£879.88

Compatible Trays:	Page
Roman Anti-Slip Trays	122 - 123
Roman Infinity Trays	124 - 125
Roman Low Level Trays	128 - 129
Roman Shield System	147

Embrace

Wetroom Panels

Straight Panels



Corner Panel

- Embrace 900mm Corner Panel ESP913S
- Roman Shield Wetroom System
- Shower Basket RSB01



Linear Panel

- Embrace 927mm Linear Panel ELLP1013S
- Roman Shield Wetroom System
- Shower Basket RSB04



900 Corner Panel

- Embrace 200mm Pivoting L Panel ESPM213S fitted to Embrace 1100mm Corner Wetroom Panel ESP1113S and Wetroom Panel ESP813S
- Glass Infinity Tray IAG168
- Shower Basket RSB01

“Roman’s wetroom panels offer style and sophistication with a seamless glass panel and sleek chrome profile.”



LBBK4590 brace bar



LBBK4590 brace bar cut to 45°

GLASS THICKNESS
8
Millimetres

TOTAL HEIGHT
2000
Millimetres

REVERSIBLE

GLASS PROTECTION
ULTRA CARE
BY ROMAN

TRUELIFE
LIFETIME GUARANTEE

Features and Benefits:

- Frame: Silver
- LBBK4590 brace bar supplied
- Two LBBK4590 brace bars supplied with Linear Panels
- Chromed top caps
- Maximum distance from wall when using bracing 1060mm
- ESP - reversible for left or right hand fixing
- Due to the nature of the product water integrity cannot be guaranteed - please consult your installer
- Tray compatibility: Tray or straight to floor using Roman Shield Wetroom System

Wetroom Panels

Size (mm)	Description	Adjustments (mm)	Code	Cost ex VAT	Cost inc VAT
600	Corner Panel	578 - 603	ESP613S	£326.67	£392.00
700	Corner Panel	678 - 703	ESP713S	£326.67	£392.00
800	Corner Panel	778 - 803	ESP813S	£326.67	£392.00
900	Corner Panel	878 - 903	ESP913S	£355.18	£426.22
1000	Corner Panel	978 - 1003	ESP1013S	£481.71	£578.05
1100	Corner Panel	1078 - 1103	ESP1113S	£501.14	£601.37
1200	Corner Panel	1178 - 1203	ESP1213S	£520.59	£624.71
1400	Corner Panel	1378 - 1403	ESP1413S	£565.16	£678.19
827	Linear Panel	35 in wall cup	ELLP913S	£506.37	£607.64
927	Linear Panel	35 in wall cup	ELLP1013S	£545.25	£654.30
1127	Linear Panel	35 in wall cup	ELLP1213S	£584.12	£700.94
1327	Linear Panel	35 in wall cup	ELLP1413S	£623.00	£747.60

For alternative styles of bracing bars please see pages 100 - 101

Compatible Trays:	Page
Roman Anti-Slip Trays	122 - 123
Roman Infinity Trays	124 - 125
Roman Low Level Trays	128 - 129
Roman Shield System	147

Pivoting 'L' Panel



Additional Features and Benefits:

- Retro-fit panel suitable for all ESP and ELLP panels
- Rotates through 180°
- Smooth pivoting motion
- Chromed decorative top caps

Pivoting 'L' Panel

Size (mm)	Adjustments (mm)	Code	Cost ex VAT	Cost inc VAT
200	n/a	ESPM213S	£193.81	£232.57
300	n/a	ESPM313S	£199.20	£239.04
400	n/a	ESPM413S	£204.57	£245.48
Where fitting with return panel is required please use one of the following				
600	578 - 603	ESP613S	£326.67	£392.00
800	778 - 803	ESP813S	£326.67	£392.00
900	878 - 903	ESP913S	£355.18	£426.22

Collage

Reduced Height Panels

Suitable when ceiling height is limited

Straight Panels



1200 Corner Panel

- Corner Panel CSP1213S with Standard Brace Bar FBBK10
- Matt Infinity Tray IA128
- Shower Basket RSB01

Retro Fit Return Panel Kit*





Features and Benefits:

Corner and Linear Panels

- Frame: Silver
- Vertical adjustment: 30mm each profile
- Tray compatibility: Tray or straight to floor using Roman Shield Wetroom System

Return Panel

- Panel foot adjusts from 8mm to 64mm to accommodate high and low level trays
- Panel foot is chromed brass with soft rubber base
- Panel foot is cut down on site to suit the shower tray
- Return panel width is 218mm
- Return panels available as an 'add on' kit CSPL213S
- All sizes suitable for wetroom floor installation

900 Linear Panel

- Linear Panel CLLP913S with Brace Bars FBBK10
- Roman Low Level Tray RLT127
- Shower Basket RSB05

Corner and Linear Panel

Size (mm)	Description	Adjustments (mm)	Brace Bars	Code	Cost ex VAT	Cost inc VAT
200	Corner Panel	247 - 277	Not included	CSP213S	£268.60	£322.32
600	Corner Panel	577 - 607	Not included	CSP613S	£268.59	£322.31
700	Corner Panel	655 - 685	Not included	CSP713S	£268.59	£322.31
800	Corner Panel	792 - 822	Not included	CSP813S	£268.59	£322.31
900	Corner Panel	892 - 922	Not included	CSP913S	£295.17	£354.20
1000	Corner Panel	992 - 1022	Inc. FBBK10	CSP1013S*	£404.82	£485.78
1200	Corner Panel	1192 - 1222	Inc. FBBK10	CSP1213S*	£441.06	£529.27
1400	Corner Panel	1392 - 1422	Inc. FBBK10	CSP1413S*	£482.60	£579.12
850	Linear Panel	N/A	Inc. Two FBBK10	CLLP913S*	£427.80	£513.36
950	Linear Panel	N/A	Inc. Two FBBK10	CLLP1013S*	£464.04	£556.85

* includes FBBK10 brace bar kit allowing adjustment of up to 1140mm from wall

Corner Panel + 'L' Shaped Panel

Size (mm)	Description	Adjustments (mm)	To suit tray size	Code	Cost ex VAT	Cost inc VAT
800 x 200	Corner + Return Panel	799 - 829	900mm and above	CSPL813S	£350.58	£420.70
900 x 200	Corner + Return Panel	899 - 929	1000mm and above	CSPL913S	£377.14	£452.57
1000 x 200	Corner + Return Panel	999 - 1029	1100mm and above	CSPL1013S	£505.72	£606.86
1200 x 200	Corner + Return Panel	1199 - 1229	1400mm and above	CSPL1213S	£541.96	£650.35
218	*Retro Fit Return Panel Kit for use with any Collage Corner or Linear Panel			CSPL213S	£129.98	£155.98

* includes FBBK10 brace bar kit allowing adjustment of up to 1140mm from wall

Compatible Trays:	Page
Roman Anti-Slip Trays	122 - 123
Roman Infinity Trays	124 - 125
Roman Low Level Trays	128 - 129
Roman Shield System	147

Lumin8

Colossus

Curved Panels



1700 Colossus

- 1700mm Colossus V8C13S
- Shower Tray FC1R (right hand)
- Shower Basket RSB06



1450 Colossus with 1 Side Panel

- 1450mm Colossus V8CG213S
- Shower Tray FCT1R (right hand)
- Shower Basket RSB06



“ The perfect bath replacement product ”



GLASS THICKNESS
8
Millimetres

REVERSIBLE

GLASS PROTECTION
ULTRA CARE
- ROMAN

TRULIFE
LIFETIME
GUARANTEE

Features and Benefits:

- Bright silver frame
- 25mm vertical adjustment
- Chrome top caps
- Tray Compatibility: Suitable for dedicated tray or straight to floor using Roman Shield Wetroom System
- Due to the nature of the product water integrity cannot be guaranteed - please consult your installer



1600 Colossus with Side Panel

- 1600mm Colossus V8GP13S

Tray Size (mm)	Description	Fixed Panel (mm)	Height (mm)	Adjustments (mm)	Aperture (mm)	Tray Compatibility Code	Code	Cost ex VAT	Cost inc VAT
1700	Colossus	1202	1950	25	478	FC1	V8C13S	£995.96	£1195.15
1700	Colossus + 1 Side Panel	1202	1950	25	456	FC1	V8CG13S	£1243.61	£1492.33
1700	Colossus + Return Panel	1202	1950	25	456	FC1	V8CGM13S	£1243.61	£1492.33
1700	Colossus + 2 Side Panels	1202	1950	25	456	FC1	V8CGR13S	£1491.24	£1789.49
1600	Curved Panel With Towel Rail	775	2000	25	791	V8GT	V8GP13S	£866.76	£1040.11
800	Optional Side Panel	706	2000	25	762	V8GT	V8GPA	£259.09	£310.91
1450	Colossus	963	1950	25	475	FCT1	V8C213S	£866.76	£1040.11
1450	Colossus + 1 Side Panel	963	1950	25	442	FCT1	V8CG213S	£1114.40	£1337.28
1450	Colossus + Return Panel	963	1950	25	442	FCT1	V8CGM213S	£1114.40	£1337.28
1450	Colossus + 2 Side Panels	963	1950	25	442	FCT1	V8CGR213S	£1362.03	£1634.44

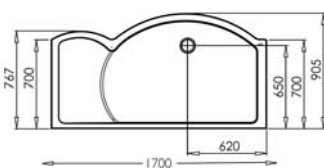

1700 FC1L - Left Hand Low Level Tray

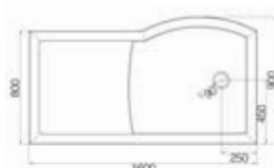

1600 V8GTL - Left Hand Low Level Tray

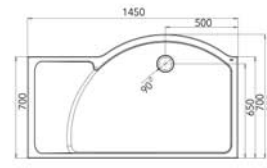

1450 FCT1L - Left Hand Low Level Tray

Tray handing must be specified - for tray colours and pricing please see page 127

Lumin8

Curved Wetroom Panel

Curved Panels



1400 Curved Panel with Side Panel

- 1400mm V8HP13S
- Side Panel V8HPA
- Tray V8HTL (left hand)

“ The curved glass sits perfectly in the specially designed tray. ”

GLASS THICKNESS
8
Millimetres

TOTAL HEIGHT
2030
Millimetres

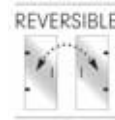

GLASS PROTECTION
ULTRA CARE
BY ROMAN

TRUETIME
LIFETIME
GUARANTEE



1400 Curved Panel

- 1400mm V8HP13S
- Tray V8HTL (left hand)

Features and Benefits:

- Glass height 2000mm
- Height to top of brace bar 2030mm
- 25mm Vertical Adjustment
- Chrome top caps
- Tray Compatibility: Suitable for dedicated tray or straight to floor using Roman Wetroom System.
- Due to the nature of the product water integrity cannot be guaranteed - please consult your installer

Panel Size (mm)	Tray Size (mm)	Description	Adjustment (mm)	Tray Size (mm)	Code	Cost ex VAT	Cost inc VAT
806	1400	Lumin8 Curved Panel	25	1400	V8HP13S	£511.43	£613.72
663	900	Lumin8 Optional Side Panel	25	900	V8HPA	£270.53	£324.64

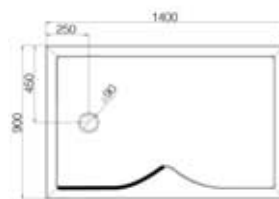

1400 V8HTL - Left Hand Low Level Tray

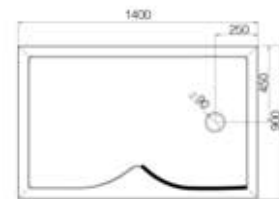

1400 V8HTR - Right Hand Low Level Tray

Tray handing must be specified - for tray colours and pricing please see page 127

Embrace

Curved Wetroom Panel

designed to suit any rectangular tray

Curved Panels



1200 x 800 Corner Fitting

- Embrace 700mm Curved Wetroom Panel ESPC713S
- Roman Low Level Tray RLT128
- Shower Basket RSB03

GLASS THICKNESS
8
Millimetres

TOTAL HEIGHT
2030
Millimetres

REVERSIBLE

GLASS PROTECTION
ULTRA CARE ROMAN

TRULIFE
LIFETIME GUARANTEE

“ I think there is always a need for pure design.
With pure design, you don't need so much decoration.”
- Jil Sander



Corner Fitting

- 800mm Curved Wetroom Panel ESPC813S
- Corner Wetroom Panel ESP713S
- Roman Low Level Tray RLT128
- Shower Basket RSB03

Features and Benefits:

- Glass Height 2000mm
- Height with brace bar 2030mm
- Frame: Silver
- Bright silver frame with 25mm of adjustment
- Chromed brass adjustable panel foot included
- Chromed top caps
- For use in alcove or corner with additional panel
- Due to the nature of the product water integrity cannot be guaranteed - please consult your installer
- Tray compatibility: Tray or straight to floor using Roman Shield Wetroom System



Adjustable foot

Size (mm)	Description	Suit Tray Size:					Adjustment (mm)	Code	Cost ex VAT	Cost inc VAT
		1100	1200	1400	1500	1600				
Provides Aperture Width:										
700	Curved Panel	460	560	N/A	N/A	N/A	615 - 640	ESPC713S	£484.52	£581.42
800	Curved Panel	N/A	390	590	N/A	N/A	785 - 810	ESPC813S	£511.43	£613.72
900	Curved Panel	N/A	N/A	490	590	690	885 - 910	ESPC913S	£538.35	£646.02

Where fitting with Corner Panel is required for corner installation (illustrated above) please use one of the following:

Size (mm)	Description	Adjustment (mm)	Code	Cost ex VAT	Cost inc VAT
600	Corner Panel	578 - 603	ESP613S	£326.67	£392.00
700	Corner Panel	678 - 703	ESP713S	£326.67	£392.00
800	Corner Panel	778 - 803	ESP813S	£326.67	£392.00
900	Corner Panel	878 - 903	ESP913S	£355.18	£426.22

Compatible Trays:	Page
Roman Anti-Slip Trays	122 - 123
Roman Infinity Trays	124 - 125
Roman Low Level Trays	128 - 129
Roman Shield System	147

Trays

- Anti-Slip Trays
- Infinity Trays
- Shimmer Trays
- Neo-Angle Trays
- Lumin8 trays
- Roman Low Level Trays

Our diverse range of trays and wetroom solutions offer the user a choice of installations depending on the desired finish.

Our range of level access shower trays is manufactured from solid surface material, and cleverly create a simulated wetroom look. These solid surface trays are available in a range of sizes, and incorporates our Infinity Tray range which has a single angle flow to waste with a stylish load bearing solid surface waste cover. Our Infinity Tray collection also presents true originality with our low level Shimmer Trays, featuring a stunning shimmer finish. These unique designs include black, grey and white shimmer finishes. The standard acrylic capped stone shower trays are also available in a selection of heights, shapes and sizes.

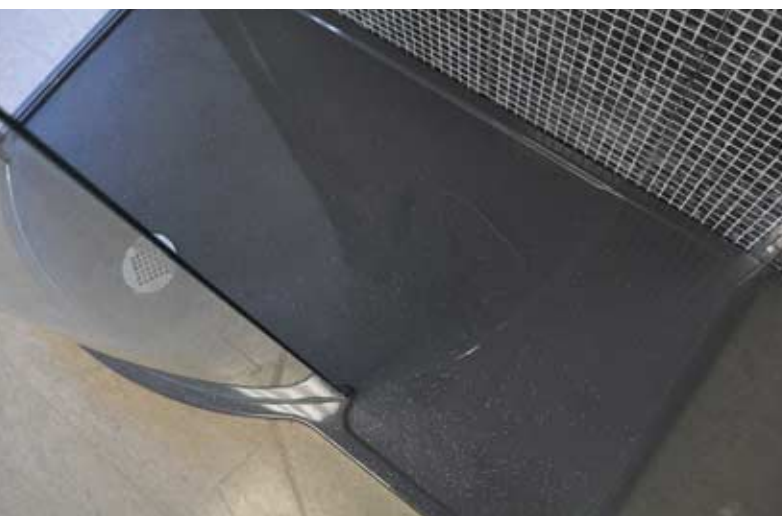

“Design is a constant challenge to balance comfort with luxe, the practical with the desirable”

Donna Karan

Anti-Slip Trays



Features and Benefits:

- Ultra low 50mm profile
- Manufactured using Roman Stone solid surface technology
- One angle of slope to waste to maximise flow rating
- Fast flow waste included
- Solid Surface Plinth and Leg Set available if required - Total height inc. tray 150mm
- Chrome plated domed waste



Anti Slip Trays

Matt Trays have been tested to:

BS7976-2:2002+A1:2013 - Slip potential - low DIN 51097:1992 Class C



Grey Anti-Slip Tray

“ Matt finish cannot wear - permanent anti-slip ”

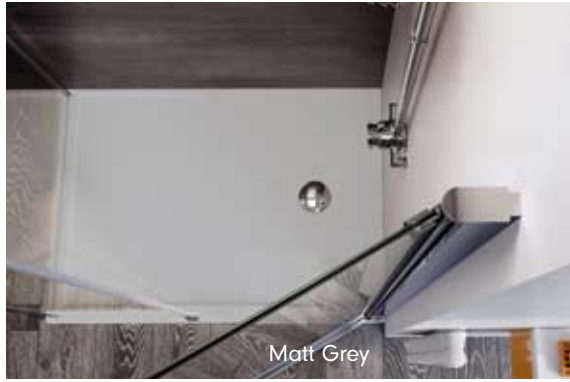

1000 x 800mm

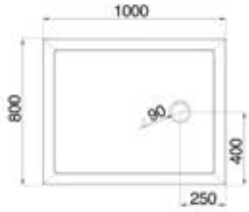

1200 x 800mm

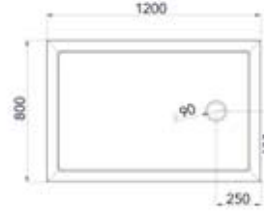

1200 x 900mm

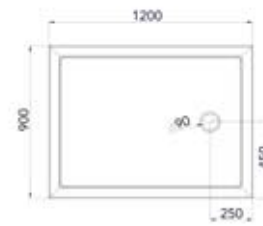

1300 x 800mm

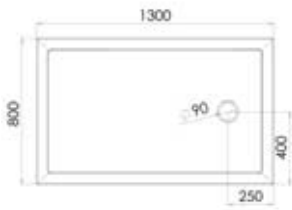

1400 x 900mm

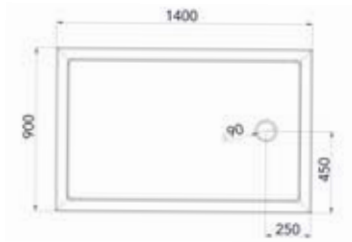

1500 x 800mm

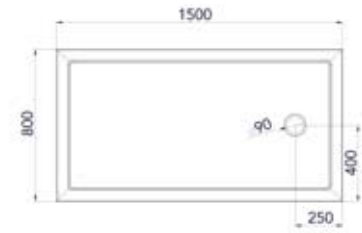

1600 x 700mm



1600 x 800mm

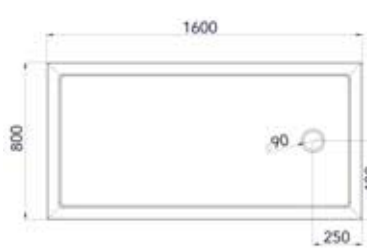

1700 x 800mm



Tray with Leg Kit

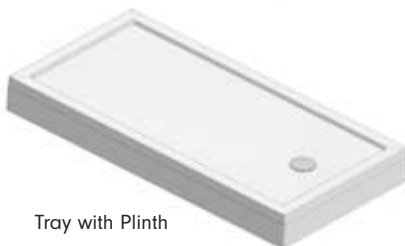

Tray with Plinth

Tray Size (mm)	Description	Finish	White Tray Code	Grey Tray Code	Cost ex VAT	Cost inc VAT
1000 x 800	Anti-Slip Tray	Matt	RST108	RST108MG	£360.57	£432.68
1200 x 800	Anti-Slip Tray	Matt	RST128	RST128MG	£410.72	£492.86
1200 x 900	Anti-Slip Tray	Matt	RST129	RST129MG	£427.79	£513.35
1300 x 800	Anti-Slip Tray	Matt	RST138	RST138MG	£453.41	£544.09
1400 x 900	Anti-Slip Tray	Matt	RST149	RST149MG	£479.03	£574.84
1500 x 800	Anti-Slip Tray	Matt	RST158	RST158MG	£487.29	£584.75
1600 x 700	Anti-Slip Tray	Matt	RST167	RST167MG	£496.10	£595.32
1600 x 800	Anti-Slip Tray	Matt	RST168	RST168MG	£496.10	£595.32
1700 x 800	Anti-Slip Tray	Matt	RST178	RST178MG	£504.92	£605.90
PLINTH AND LEG SET						
Standard Riser Kit			RSTRK01	RSTRK02	£160.01	£192.01

Infinity Trays

Level Access Installation



Anti-Slip options*

Our Infinity Trays offer a breakthrough in technology as they can be installed straight to joists so that once the floor tiles are laid it creates level entry access into the shower area. Manufactured from Roman Stone, the Infinity Trays are strong and durable. This product provides the added reassurance of a tray, with the minimalist design and level access of a wetroom. The waste is suitable for power shower systems and carries away 25 litres of water per minute.



Features and Benefits:

- Ultra low profile 40mm nominal height
- Gloss or Matt* finish available in white
- Shimmer options in gloss only
- Manufactured using Roman Stone Solid Surface Technology
- One angle of slope to waste to maximise flow rating
- Fast flow waste included, fully concealed with solid surface cover piece
- Due to the nature of the product water integrity cannot be guaranteed when fitting with a wetroom panel. Please consult your installer



* Anti Slip Trays
 Matt Trays have been tested to:
 BS7976-2:2002+A1:2013 - Slip potential - low DIN 51097:1992 Class C

Shimmer Trays

Exclusive additions to our Infinity Tray collection are original low level shower trays, featuring a stunning shimmer finish. These unique additions include a black, grey and white shimmer finishes.



Grey Shimmer



Black Shimmer



White Shimmer

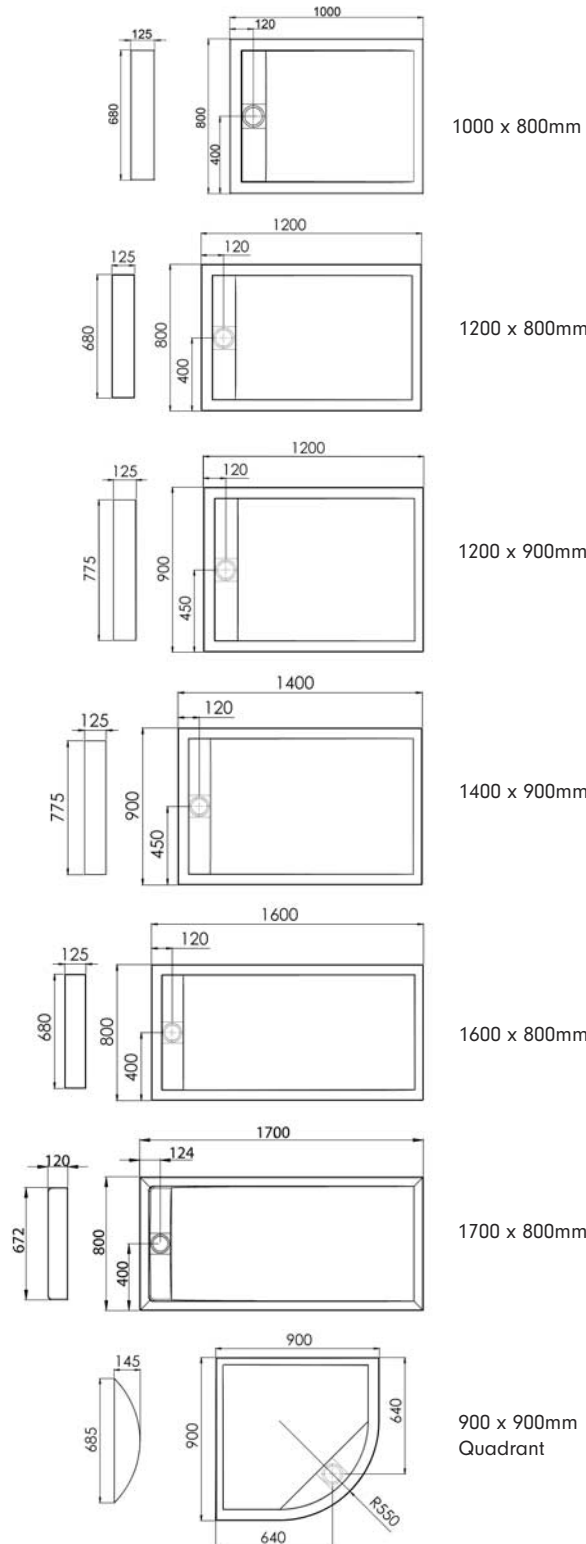

Size (mm)	Colour	Finish	Code	Cost ex VAT	Cost inc VAT
RECTANGLE					
1000 x 800	White	Matt	IA108*	£409.85	£491.82
1000 x 800	White	Gloss	IAG108	£438.31	£525.97
1000 x 800	Shimmer Black	Gloss	IAG108B	£534.35	£641.22
1000 x 800	Shimmer White	Gloss	IAG108W	£534.35	£641.22
1000 x 800	Shimmer Grey	Gloss	IAG108G	£534.35	£641.22
1200 x 800	White	Matt	IA128*	£461.09	£553.31
1200 x 800	White	Gloss	IAG128	£489.54	£587.45
1200 x 800	Shimmer Black	Gloss	IAG128B	£583.93	£700.72
1200 x 800	Shimmer White	Gloss	IAG128W	£583.93	£700.72
1200 x 800	Shimmer Grey	Gloss	IAG128G	£583.93	£700.72
1200 x 900	White	Matt	IA129*	£478.16	£573.79
1200 x 900	White	Gloss	IAG129	£506.62	£607.94
1200 x 900	Shimmer Black	Gloss	IAG129B	£600.46	£720.55
1200 x 900	Shimmer White	Gloss	IAG129W	£600.46	£720.55
1200 x 900	Shimmer Grey	Gloss	IAG129G	£600.46	£720.55
1400 x 900	White	Matt	IA149*	£529.39	£635.27
1400 x 900	White	Gloss	IAG149	£557.85	£669.42
1400 x 900	Shimmer Black	Gloss	IAG149B	£650.03	£780.04
1400 x 900	Shimmer White	Gloss	IAG149W	£650.03	£780.04
1400 x 900	Shimmer Grey	Gloss	IAG149G	£650.03	£780.04
1600 x 800	White	Matt	IA168*	£546.47	£655.76
1600 x 800	White	Gloss	IAG168	£574.92	£689.90
1600 x 800	Shimmer Black	Gloss	IAG168B	£666.56	£799.87
1600 x 800	Shimmer White	Gloss	IAG168W	£666.56	£799.87
1600 x 800	Shimmer Grey	Gloss	IAG168G	£666.56	£799.87
1700 x 800	White	Matt	IA178*	£569.36	£683.23
1700 x 800	White	Gloss	IAG178	£597.82	£717.38
1700 x 800	Shimmer Black	Gloss	IAG178B	£689.46	£827.35
1700 x 800	Shimmer White	Gloss	IAG178W	£689.46	£827.35
1700 x 800	Shimmer Grey	Gloss	IAG178G	£689.46	£827.35
QUADRANT					
900 x 900	White	Matt	IA9Q*	£392.78	£471.34
900 x 900	White	Gloss	IAG9Q	£421.23	£505.48
900 x 900	Shimmer Black	Gloss	IAG9QB	£517.82	£621.38
900 x 900	Shimmer White	Gloss	IAG9QW	£517.82	£621.38
900 x 900	Shimmer Grey	Gloss	IAG9QG	£517.82	£621.38

Neo-Angle Trays



Features and Benefits:

- Ultra low profile
- Gloss or Matt* finish available in white
- Shimmer options in gloss only
- Manufactured using Roman Stone Solid Surface Technology

Anti-Slip options*



DNT9



DNT129 Right Hand

DNT129 Left Hand

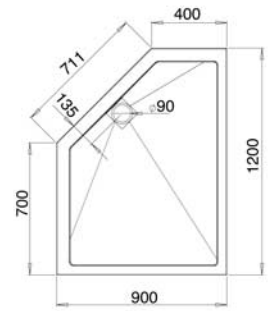
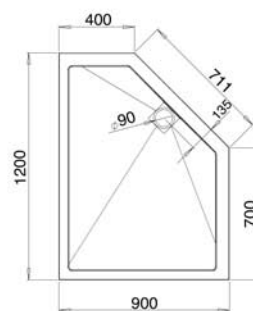
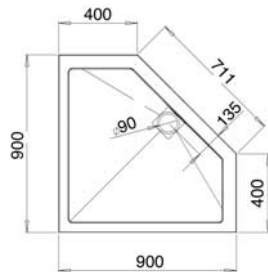

“ 25 litres per minute drainage ”

Waste Dimensions

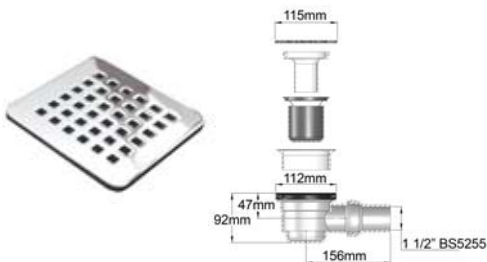

Size (mm)	Tray Colour	Finish	Code	Cost ex VAT	Cost inc VAT
900	White	Matt	DNT9*	£352.56	£423.07
900	White	Gloss	DNTG9	£380.11	£456.13
1200 x 900 LH	White	Matt	DNT129L*	£435.20	£522.24
1200 x 900 LH	White	Gloss	DNTG129L	£462.73	£555.28
1200 x 900 RH	White	Matt	DNT129R*	£435.20	£522.24
1200 x 900 RH	White	Gloss	DNTG129R	£462.73	£555.28
900	Shimmer Black	Gloss	DNT9B	£490.28	£588.34
1200 x 900 LH	Shimmer Black	Gloss	DNT129LB	£572.91	£687.49
1200 x 900 RH	Shimmer Black	Gloss	DNT129RB	£572.91	£687.49
900	Shimmer White	Gloss	DNT9W	£490.28	£588.34
1200 x 900 LH	Shimmer White	Gloss	DNT129LW	£572.91	£687.49
1200 x 900 RH	Shimmer White	Gloss	DNT129RW	£572.91	£687.49
900	Shimmer Grey	Gloss	DNT9G	£490.28	£588.34
1200 x 900 LH	Shimmer Grey	Gloss	DNT129LG	£572.91	£687.49
1200 x 900 RH	Shimmer Grey	Gloss	DNT129RG	£572.91	£687.49



* Anti Slip Trays
 Matt Trays have been tested to:
 BS7976-2:2002+A1:2013 - Slip potential - low DIN 51097:1992 Class C

Lumin8 Trays

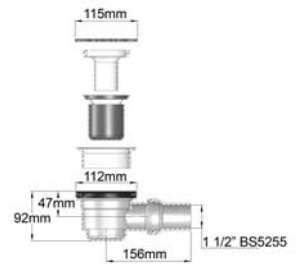

Lumin8 Tray Waste Dimensions

Features and Benefits:

- Ultra low profile
- 50mm nominal height
- Roman Stone Solid Surface Technology
- Gloss gel coated surface and matt satin options
- Includes chrome grid waste and fast flow trap
- Suitable for use with power shower systems rated up to 25 litres per minute

All Lumin8 Trays are right or left handed depending upon requirements. Please ensure you order the correct code for the handing required.

LH = Left Hand RH = Right Hand

Anti-Slip options*



* Anti Slip Trays

Matt Trays have been tested to:

BS7976-2:2002+A1:2013 -Slip potential - low DIN 51097:1992 Class C

Lumin8 Colossus Tray

(see pages 114 - 115 for Lumin8 Colossus details)

Lumin8 1450 Colossus Tray

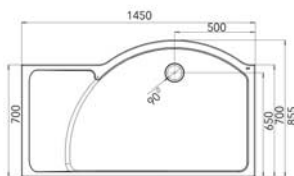

Left Hand FCT1L

Lumin8 1600 Colossus Tray

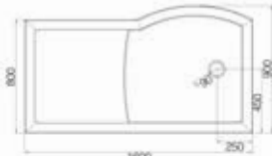

Left Hand V8GT

Lumin8 1700 Colossus Tray

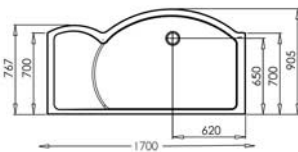

Left Hand - FC1L

Size (mm)	Tray Colour	Finish	Code	Cost ex VAT	Cost inc VAT
1700 x 700 LH	White	Matt	FC1L*	£584.12	£700.94
1700 x 700 RH	White	Matt	FC1R*	£584.12	£700.94
1700 x 700 LH	White	Gloss	FCG1L	£611.93	£734.32
1700 x 700 RH	White	Gloss	FCG1R	£611.93	£734.32
1700 x 700 LH	Shimmer Black	Gloss	FCG1LB	£699.86	£839.83
1700 x 700 RH	Shimmer Black	Gloss	FCG1RB	£699.86	£839.83
1700 x 700 LH	Shimmer White	Gloss	FCG1LW	£699.86	£839.83
1700 x 700 RH	Shimmer White	Gloss	FCG1RW	£699.86	£839.83
1700 x 700 LH	Shimmer Grey	Gloss	FCG1LG	£699.86	£839.83
1700 x 700 RH	Shimmer Grey	Gloss	FCG1RG	£699.86	£839.83
1600 x 800 LH	White	Matt	V8GTLW*	£584.12	£700.94
1600 x 800 LH	Grey	Matt	V8GTLG*	£584.12	£700.94
1600 x 800 RH	White	Matt	V8GTRW*	£584.12	£700.94
1600 x 800 RH	Grey	Matt	V8GTRG*	£584.12	£700.94
1450 x 700 LH	White	Matt	FCT1L*	£567.43	£680.92
1450 x 700 RH	White	Matt	FCT1R*	£567.43	£680.92
1450 x 700 LH	White	Gloss	FCTG1L	£595.24	£714.29
1450 x 700 RH	White	Gloss	FCTG1R	£595.24	£714.29
1450 x 700 LH	Shimmer Black	Gloss	FCTG1LB	£683.72	£820.46
1450 x 700 RH	Shimmer Black	Gloss	FCTG1RB	£683.72	£820.46
1450 x 700 LH	Shimmer White	Gloss	FCTG1LW	£683.72	£820.46
1450 x 700 RH	Shimmer White	Gloss	FCTG1RW	£683.72	£820.46
1450 x 700 LH	Shimmer Grey	Gloss	FCTG1LG	£683.72	£820.46
1450 x 700 RH	Shimmer Grey	Gloss	FCTG1RG	£683.72	£820.46

Lumin8 Curved Panel Tray

(see pages 116 - 117 for Lumin8 Curved Wetroom Panel)

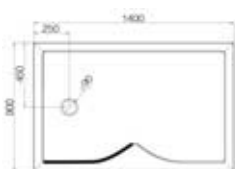

Left Hand - V8HTL

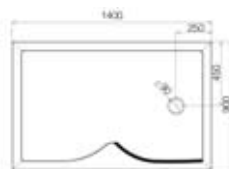

Right Hand - V8HTR

Size (mm)	Tray Colour	Finish	Code	Cost ex VAT	Cost inc VAT
1400 x 900 LH	White	Matt	V8HTLW*	£567.43	£680.92
1400 x 900 LH	Grey	Matt	V8HTLG*	£567.43	£680.92
1400 x 900 RH	White	Matt	V8HTRW*	£567.43	£680.92
1400 x 900 RH	Grey	Matt	V8HTRG*	£567.43	£680.92

Roman Trays

Acrylic Capped Stone

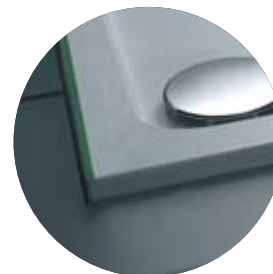

Chrome plated domed waste

Features and Benefits:

- Low profile - only 40mm in height
- Available with optional leg kits to create raised version
- Manufactured from a composite resin capped acrylic
- Gloss finish
- Height of panel kits 95mm
- 90mm Domed Waste included



Square



Rectangle



The power shower approved, easy clean, 90mm rapid drain outlet works with the sleek lines of the tray, allowing up to 32 litres of water to be carried away per minute. Manufactured from composite resin capped acrylic it is easy to install as it offers the option of flat to floor or raised on legs installation.

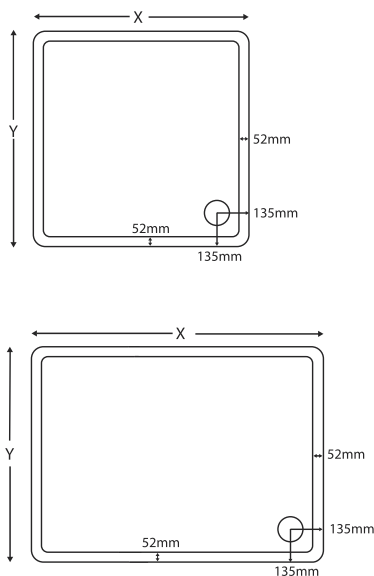

Size (mm)	X	Y	Tray Code	Optional Riser Kit Code	Cost ex VAT	Cost inc VAT
Roman Square Tray						
760mm	x	760mm	RLT76	RTPK03	£132.90	£159.48
800mm	x	800mm	RLT80	RTPK03	£153.82	£184.58
900mm	x	900mm	RLT90	RTPK03	£209.19	£251.03
1000mm	x	1000mm	RLT100	RTPK04	£332.24	£398.69
Roman Rectangle Tray						
900mm	x	760mm	RLT79	RTPK03	£221.49	£265.79
1000mm	x	760mm	RLT107	RTPK03	£227.65	£273.18
1000mm	x	800mm	RLT108	RTPK03	£246.11	£295.33
1000mm	x	900mm	RLT109	RTPK03	£252.26	£302.71
1100mm	x	800mm	RLT118	RTPK03	£252.26	£302.71
1100mm	x	900mm	RLT119	RTPK03	£252.26	£302.71
1200mm	x	760mm	RLT127	RTPK03	£239.95	£287.94
1200mm	x	800mm	RLT128	RTPK03	£239.95	£287.94
1200mm	x	900mm	RLT129	RTPK03	£270.72	£324.86
1400mm	x	900mm	RLT149	RTPK04	£387.62	£465.14
1500mm	x	800mm	RLT158	RTPK04	£436.84	£524.21
1600mm	x	800mm	RLT168	RTPK04	£479.90	£575.88
1700mm	x	800mm	RLT178	RTPK04	£504.52	£605.42
1800mm	x	800mm	RLT188	RTPK04	£553.88	£664.66
Riser Kits and Waste						
1200mm Square / Rectangle Panel Kit + feet				RTPK03	£92.29	£110.75
1800mm Rectangle Panel Kit + feet				RTPK04	£92.29	£110.75
Roman Tray Waste (90mm)				RTW	£36.92	£44.30



Riser Panel Kit shown with legs and front panel



Quadrant

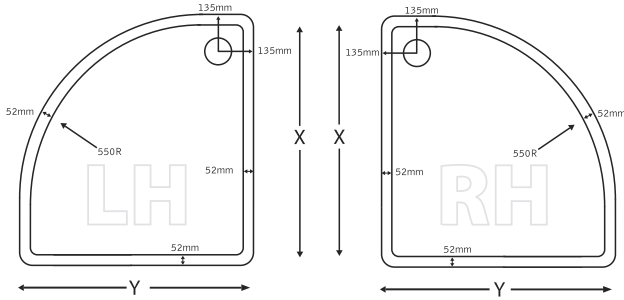
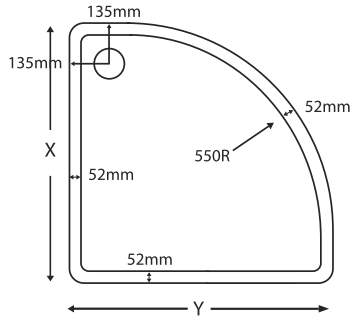

* Left or right handing must be specified



Size (mm)		Tray Code	Optional Riser Kit Code	Cost ex VAT	Cost inc VAT
X	Y				
Roman Quadrant Tray					
800mm	x 800mm	RLQ80	RTPK01	£190.73	£228.88
900mm	x 800mm LH	RLQ89L*	RTPK01	£233.80	£280.56
900mm	x 800mm RH	RLQ89R*	RTPK01	£233.80	£280.56
900mm	x 900mm	RLQ90	RTPK01	£233.80	£280.56
900mm	x 760mm LH	RLQ976L*	RTPK02	£264.56	£317.47
900mm	x 760mm RH	RLQ976R*	RTPK02	£264.56	£317.47
1000mm	x 1000mm	RLQ100	RTPK01	£283.02	£339.62
1000mm	x 800mm LH	RLQ108L*	RTPK02	£301.48	£361.78
1000mm	x 800mm RH	RLQ108R*	RTPK02	£301.48	£361.78
1200mm	x 800mm LH	RLQ128L*	RTPK02	£375.31	£450.37
1200mm	x 800mm RH	RLQ128R*	RTPK02	£375.31	£450.37
1200mm	x 900mm LH	RLQ129L*	RTPK02	£375.31	£450.37
1200mm	x 900mm RH	RLQ129R*	RTPK02	£375.31	£450.37
Riser Kits and Waste					
Quadrant Panel Kit + feet			RTPK01	£92.29	£110.75
Off Set Quadrant Panel Kit + feet			RTPK02	£92.29	£110.75
Roman Tray Waste (90mm)			RTW	£36.92	£44.30

Anti-Slip Kit

by Roman



Anti Slip Advantages:

- Added reassurance in wet showers
- Easy to apply - after tray installation
- Hygienic and low maintenance
- Resilient and durable
- Solvent free
- Colourless

Possible Areas of Use:

- Shower trays
- Retirement homes and nursing homes
- Clinics and rehabilitation facilities
- Only for use with Roman Acrylic Capped Stone Trays

Description	Code	Cost ex VAT	Cost inc VAT
Anti Slip Coating Pack	RTAS01	£86.14	£103.37

Bath Screens

Bath Screens continue to be a very popular choice as around 65% of UK bathrooms have showering facilities over the bath, due to the shrinking size of UK bathroom and the growing popularity of multiple bathrooms in the family home.

Many homes in the UK now have two or three bathrooms, which tend to be smaller and more compact as opposed to a spacious family bathroom. Due to this Bath Screens have increased in popularity as they are often specified for the main family bathroom to give an additional showering facility, which helps to overcome the morning rush to the shower. Combi-boilers and higher pressure plumbing systems have now created a demand for power shower approved bath screens.

Roman's extensive range of Bath Screens offers something to suit everyone's requirements and style of bathroom. We offer a range of sizes, shapes, glass thicknesses and styles designed to fit around any existing bathroom fixtures and fittings. Our range includes power shower approved bath screens for a superior showering experience, which incorporate a unique seal system for added water integrity.

“ I strive for simplicity and believe simplicity is beauty ”
- Allan Alder

GLASS THICKNESS
10
Millimetres

TOTAL HEIGHT
1500
Millimetres

REVERSIBLE

GLASS PROTECTION
ULTRA CARE
BY ROMAN

TRUELIFE
LIFETIME GUARANTEE

Decem

Hinged Bath Screen

Outward Opening



- Bath Screen DXBLB
- Shower Basket RSB02

Features and Benefits:

- Self-closing hinges
- Choice of curved or straight chromed brass hinges
- Outward opening for ease of cleaning
- Integrated 'bathtop' Water Safe System for excellent water integrity
- Suitable for use with power showers
- 15mm of adjustment in each minimal wall profile for easy installation



Square Hardware



Curved Hardware



“Luxury 10mm thick toughened glass”

Bath Screen Width (mm)	Hardware Style	Adjustment (mm)	Code	Cost ex VAT	Cost inc VAT
830	Curved	815 - 830	DXBLA	£567.56	£681.07
830	Square	815 - 830	DXBLB	£567.56	£681.07

GLASS
THICKNESS
8
Millimetres

TOTAL
HEIGHT
1500
Millimetres

GLASS
PROTECTION
**ULTRA
CARE**
BY ROMAN

TRULIFE
**LIFETIME
GUARANTEE**

Innov8

Folding Bath Screen

Outward Opening



- Innov8 Frameless Folding Bath Screen N2BV213BL (left hand)

“Introducing the new matt black metal finish on this stunning hinged bath screen”

GLASS THICKNESS
8
Millimetres

TOTAL HEIGHT
1500
Millimetres

GLASS PROTECTION
ULTRA CARE
BY ROMAN

TRUELIFE
LIFETIME
GUARANTEE

Features and Benefits:



- Adjustment 890 - 910mm
- Outward opening (hinges stop at 90° to avoid contact with basins and furniture)
- Optional Bracing Bar included
- Bath top aluminium seal for added water integrity
- Power shower approved
- Left or right handing must be specified

“8mm thick glass for a substantial finish and minimalist framing for a designer look”



• Innov8 Outward Folding Bath Screen N2BV213SL

Left Hand illustration

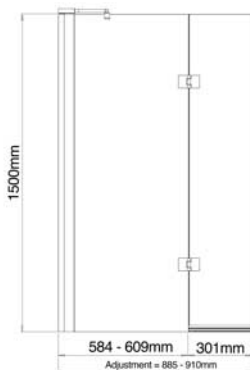

Please note this outward opening panel stops at 90° to avoid colliding with any furniture - ideal for small compact bathrooms and hotel rooms

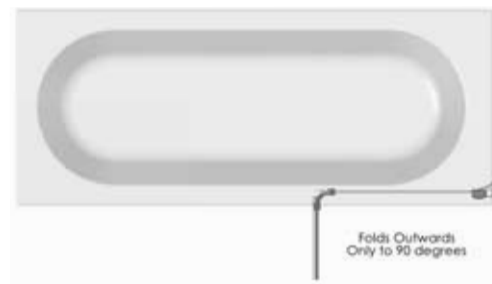

Description	Frame Colour	Handing	Width (mm)	Adjustments (mm)	Code	Cost ex VAT	Cost inc VAT
Outward Opening Bath Screen	Black	Left Hand	910	890 - 910	N2BV213BL	£519.03	£622.84
Outward Opening Bath Screen	Black	Right Hand	910	890 - 910	N2BV213BR	£519.03	£622.84
Outward Opening Bath Screen	Silver	Left Hand	910	890 - 910	N2BV213SL	£519.03	£622.84
Outward Opening Bath Screen	Silver	Right Hand	910	890 - 910	N2BV213SR	£519.03	£622.84

Innov8

Hinged Bath Screens

Inward Opening



Features and Benefits:

- Frame: Silver
- Vertical adjustment: 20mm
- Horizontal PVC seal and vertical magnetic seals
- Inward opening only
- Fixed panel and pivoting screen
- Bath top aluminium seal for added water integrity
- Suitable for use with power showers
- Left or right handing must be specified



Innov8 Folding Bath Screen in closed position.



- Innov8 Folding Bath Screen N2BV13SL
- Shower Basket RSB05

“As used in top hotels all over the world”



Left Hand



Right Hand

Description	Frame Colour	Handing	Width (mm)	Adjustments (mm)	Code	Cost ex VAT	Cost inc VAT
Inward Opening Bath Screen	Silver	Left Hand	900	880 - 900	N2BV13SL	£519.03	£622.84
Inward Opening Bath Screen	Silver	Right Hand	900	880 - 900	N2BV13SR	£519.03	£622.84

GLASS THICKNESS
8
Millimetres

TOTAL HEIGHT
1500
Millimetres

GLASS PROTECTION
ULTRA CARE
BY ROMAN

TRUELIFE
LIFETIME
GUARANTEE

Lumin8

Frameless Bath Screen



Inward or Outward Opening

Features and Benefits:



- Chromed brass hinges
- Bright silver frame
- Power shower approved with unique seal system
- 25mm vertical adjustment in each profile
- Glass pre-coated with Roman Ultra Care
- V8B13S - reversible for left or right hand fixing
- V8BL13S - left or right handing must be specified

“Designed to work around existing fixtures and fittings”

- Lumin8 Frameless Bath Screen V8B13S
- Shower Basket RSB06



Outward Opening

- Lumin8 Frameless Hinged Bath Screen V8BL13SR (right hand)
- Shower Basket RSB06



Inward or Outward Opening

- Lumin8 Bath Screen V8B28S



Fixed Screen

- Lumin8 Fixed Bath Screen V8BS13S
- Shower Basket RSB06

*Please indicate left or right handing when ordering e.g. V8BL13SL or V8BL13SR

Description	Width (mm)	Glass	Adjustments (mm)	Code	Cost ex VAT	Cost inc VAT
Frameless Bath Screen	835	Clear	810 - 835	V8B13S	£314.79	£377.75
Frameless Hinged Bath Screen	835	Clear	810 - 835	V8BL13S*	£367.26	£440.71
Frameless Bath Screen	835	Victoriana	810 - 835	V8B28S	£377.74	£453.29
Frameless Fixed Bath Screen	800	Clear	783 - 808	V8BS13S	£284.02	£297.62

GLASS
THICKNESS
8
Millimeters

TOTAL
HEIGHT
1500
Millimeters

REVERSIBLE

GLASS
PROTECTION
**ULTRA
CARE**
BY ILLUMIN

TRUELIFE

LIFETIME
GUARANTEE

Lumin8

Pivoting Bath Screen

Inward Opening



- Lumin8 Inward Folding Bath Screen V8BV13B

GLASS THICKNESS
8
Millimetres

TOTAL HEIGHT
1500
Millimetres

REVERSIBLE

GLASS PROTECTION
ULTRA CARE
by HUMAN

TRUELIFE

LIFETIME GUARANTEE

Inward Opening



Features and Benefits:



- Bright silver or Matt Black frame
- 25mm vertical adjustment in each profile



• Lumin8 Inward Folding Bath Screen V8BV13S

“ Its discreet inward folding panel ensures it avoids contact with all existing bathroom furniture ”

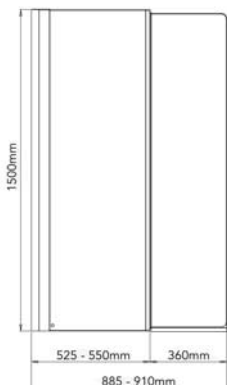

Description	Width Open (mm)	Width Closed (mm)	Adjustments (mm)	Code	Cost ex VAT	Cost inc VAT
Chrome Frame	885 - 910	525 - 550	885 - 910	V8BV13S	£338.63	£406.36
Black Frame	885 - 910	525 - 550	885 - 910	V8BV13B	£338.63	£406.36

GLASS
THICKNESS
6
Millimetres

TOTAL
HEIGHT
1500
Millimetres

REVERSIBLE

GLASS
PROTECTION
**ULTRA
CARE**
BY ROMAN

TRULIFE

LIFETIME
GUARANTEE

Embrace

Bath Screens

Inward and Outward Opening



- Embrace Matt Black Bath Screen EB13B
- Shower Basket RSB04

GLASS THICKNESS
6
Millimetres

TOTAL HEIGHT
1500
Millimetres

REVERSIBLE

GLASS PROTECTION
ULTRA CARE
- ROMAN

TRUELIFE

LIFETIME GUARANTEE



Fixed Screen

- Embrace Fixed Bath Screen EBS13S
- Shower Basket RSB04

Features and Benefits:



- Frame: Silver or Matt Black
- Unique sealing system between vertical and horizontal aluminium
- Suitable for use with power showers
- EB213S suitable for use with smaller baths (i.e. 1500mm)



Inward or Outward Opening

- Embrace Bath Screen EB13S
- Shower Basket RSB04



Inward or Outward Opening

- Embrace Frosted Bath Screen EB99S

Description	Width (mm)	Glass	Frame Colour	Adjustments (mm)	Code	Cost ex VAT	Cost inc VAT
Standard Screen	820	Clear	Silver	810 - 835	EB13S	£269.30	£323.16
Standard Screen	820	Clear	Matt Black	810 - 830	EB13B	£269.30	£323.16
Short Screen	700	Clear	Silver	678 - 703	EB213S	£269.30	£323.16
Frosted Screen	820	Frosted	Silver	810 - 835	EB99S	£320.02	£384.02
Fixed Bath Screen	800	Clear	Silver	787 - 812	EBS13S	£209.85	£251.82

GLASS THICKNESS
6
Millimetres

TOTAL HEIGHT
1500
Millimetres

REVERSIBLE

GLASS PROTECTION
ULTRA CARE
BY ROMAN

TRULIFE

LIFETIME GUARANTEE

Embrace

Folding Bath Screen

Inward Opening



• Embrace Inward folding Bath Screen EBV213S

“Perfect solution for over the bath showering”

Features and Benefits:

- Frame: Silver
- Width: open 525 - 550mm/closed 885 - 910mm
- Frameless with radius glass
- Suitable for use with power showers
- Optional brace bar included



Description	Width (mm)	Adjustments (mm)	Code	Cost ex VAT	Cost inc VAT
Inward Folding Screen	910	885 - 910	EBV213S	£286.59	£343.91

Embrace

Bath Screen

GLASS THICKNESS
6
Millimetres

TOTAL HEIGHT
1500
Millimetres

REVERSIBLE

GLASS PROTECTION
ULTRA CARE
BY ROMAN

TRULIFE
LIFETIME
GUARANTEE

Inward and Outward Opening



• Embrace Folding Bath Screen EBV13S

Features and Benefits:

- Frame: Silver
- A. Width: 920mm when fully open
- B. Width: 520mm when in closed position 1
- C. Width: 450mm when in closed position 2
- D. Width: 430mm when in closed position 3
- Vertical adjustment: 25mm
- Full length magnetic PVC seals
- Unique sealing system between the vertical and horizontal aluminium
- Suitable for use with power showers
- Optional brace bar included



“ It features a unique sealing system to ensure areas prone to leakage remain water tight whilst allowing 180° movement of the glass panel ”

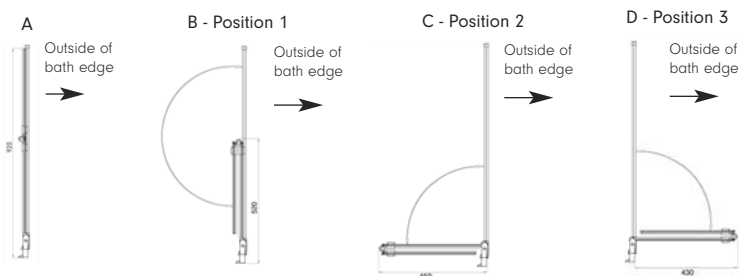

Description	Width (mm)	Adjustments (mm)	Code	Cost ex VAT	Cost inc VAT
Folding Screen	920	895 - 920	EBV13S	£465.70	£558.84



Collage

Curved Bath Screen

Inward and Outward Opening



Features and Benefits:

- Frame: Silver
- Suitable for all standard bath mixer and electric showers
- Not recommended for use with pumped or pressurised systems
- Vertical and horizontal PVC seals

“An elegant curved design for over the bath showering.”

- Collage Curved Bath Screen CB13S
- Shower Basket RSB02

Frame	Adjustments (mm)	Code	Cost ex VAT	Cost inc VAT
Silver	810 - 825	CB13S	£172.66	£207.20

Jupiter

Bath Screens

Inward and Outward Opening



- Jupiter Standard Bath Screen JBL13S



- Jupiter Curved Bath Screen JB13S

Features and Benefits:

- Suitable for all standard bath mixer and electric showers
- Not recommended for use with pumped or pressurised systems
- Colourless vertical and horizontal PVC seals
- Rotates through 180° for access
- Supplementary sealing kit available for added water integrity

Description	Frame	Adjustments (mm)	Code	Cost ex VAT	Cost inc VAT
Standard	Silver	810 - 825	JBL13S	£144.15	£172.98
Curved	Silver	810 - 825	JB13S	£136.43	£163.72

GLASS THICKNESS
8
Millimetres

TOTAL HEIGHT
1500
Millimetres

REVERSIBLE

GLASS PROTECTION
ULTRA CARE
BY RIBMAN

TRULIFE
LIFETIME GUARANTEE

Lumin8

Mini Fixed Bath Screen

Curved Rail



• Lumin8 Mini Fixed Screen with Curved Rail V8CC213S

V8CC113S - The Mini-Fixed Screen complements an existing curtain rail installation and reduces splashing around the back of the curtain and water seepage along the top end of the bath.

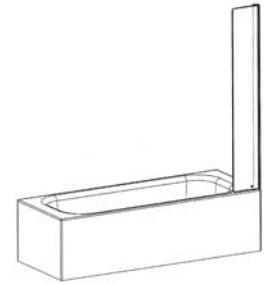

V8CC213S - The Mini-Fixed Screen complete with curtain rail (no curtain included) and wall attachments ensures a watertight shield to retain water in the bath. The curtain is held in place at the top and is less likely to allow water leakage out of the bath area. Rail length to suit 1700mm bath maximum.

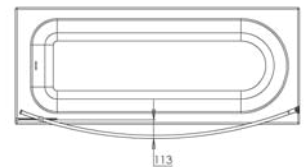

“If you do it right, it will last forever.”
- Massimo Vignelli

Features and Benefits:

- Frame: Silver
- Suitable for all standard bath mixer and electric showers (non-pumped)
- To be used in conjunction with shower curtains (no hooks or curtain supplied)
- Curved rail to increase showering comfort with a curtain

Description	Adjustment (mm)	Code	Cost ex VAT	Cost inc VAT
Mini-Fixed Panel	243 - 257	V8CC113S	£153.82	£184.58
Mini-Fixed Panel with Curtain Rail	243 - 257	V8CC213S	£205.09	£246.11

Accessories



“ Practical and stylish storage ”



RSB01

- Double Hanging Basket with Hooks
- Available Chrome or Matt Black

Spacers supplied so basket can be hung directly onto the glass edge

RSB01B



RSB02

- Large Curved Corner Basket
- Available Chrome or Matt Black



RSB02B



RSB03

- Chrome Stepped Soap Basket



RSB04

- Chrome large 'L' Shaped Corner Basket





RSB05B



RSB05

- Double Corner Basket with Hooks RSB05
- Available Chrome or Matt Black

RSB06

- Chrome large Rectangular Basket



RSB07

- Double Rectangular 'single wall' Basket with Hooks
- Available Chrome or Matt Black



RSB0100

- Roman Shower Blade (includes spare blade part)
- Available Chrome or Matt Black



RSB0100B

Description	Dimensions (mm)	Chrome Finish Code	Cost ex VAT	Cost inc VAT	Matt Black Finish Code	Cost ex VAT	Cost inc VAT
Double Hanging Basket with Hooks	D: 125mm W: 220mm H: 765mm	RSB01	£171.23	£205.48	RSB01B	£181.50	£217.80
Large Curved Corner Basket	D: 224mm W: 296mm H: 73mm	RSB02	£88.20	£105.84	RSB02B	£93.50	£112.20
Stepped Soap Basket	D: 131mm W: 260mm H: 57mm & 29mm	RSB03	£79.12	£94.94			
Large 'L' Shaped Corner Shower Basket	D: 115/125mm W: 255/270mm H: 99mm	RSB04	£115.45	£138.54			
Double Corner Shower Basket with Hooks	D: 224mm W: 293mm H: 399mm	RSB05	£149.17	£179.00	RSB05B	£158.12	£189.74
Large Rectangular Shower Basket	D: 120mm W: 260mm H: 95mm	RSB06	£88.20	£105.84			
Double Rectangular 'single wall' Shower Basket with Hooks	D: 106mm W: 215mm H: 391mm	RSB07	£120.64	£144.77	RSB07B	£127.88	£153.46
Roman Shower Blade (includes spare blade part)	-	RSB0100	£34.37	£41.24	RSB0100B	£36.44	£43.73

Black Grid Mirrors

Our bold industrial style window mirrors will make a statement in any room. These mirrors encapsulate factory chic with an elegant twist presenting a fabulous accent for the industrial trend. The mirrors feature printed glass and are suitable to be used in any room including bathrooms. The mirrors are made with 6mm safety glass.

Cleaning and care guidance:

Treat them like any other mirrored surface, use a lint free cloth and a purposely manufactured cleaning agent, designed for mirrors. Don't use anything abrasive.



Description	Size (mm)	Code	Cost ex VAT	Cost inc VAT
Square Black Grid Mirror	950 x 950mm	MIR01	£131.88	£158.26
Arched Black Grid Mirror	1100 x 750mm	MIR02	£153.85	£184.62

Choosing the right wetroom system

ROMAN SHIELD
Wetroom System

TRUELIFE
10 YEAR
GUARANTEE



The Roman Shield Wetroom System - winner of the KBB Readers' Design Award 2009



Winner of the Homebuilding and Renovating Magazine Best Bathroom Product 2011

Total area to be tanked = a + b + c.

a & b = showering area (floor to ceiling coverage.)

NOTE:

Tanking for the showering area should be applied 100mm past the showering area walls into the splash zone. (E.g. 0.9 x 0.9m showering area = tanking wall to ceiling: 1 x 1m).

c = floor coverage * the entire floor should be tanked with a turn up of 0.1m onto the walls.

EXAMPLE:

(showering area 0.9 x 0.9m, room height of 2m and floor size 2m x 2m)

a = 1 x 2 = 2m² b = 1 x 2 = 2m² c = 2 x 2 = 4m²

Total area to be tanked = 8.0m²*

* The entire floor area should be tanked with a turn up of 0.1m onto the walls - you will need to allow extra in your calculation for this.

Roman Shield requirement:

Based on the above calculation one RSH01 – Roman tanking kit will be required covering 10m².

NOTE:

The Roman Shield tape is supplied in a 15m roll and is used to seal all wall to wall and wall to floor joints as well as screw heads. Calculate how much you will need based on your room size and number of joints to cover.

If you wish to use any optional extras such as the internal corners (RSH02) or external corners (RSH04) please calculate based on your site requirements.

The above calculation is for guidance only, coverage of the tanking kit will vary depending on application technique used (roller/brush) and site conditions.

To calculate the Roman Shield tanking coverage:

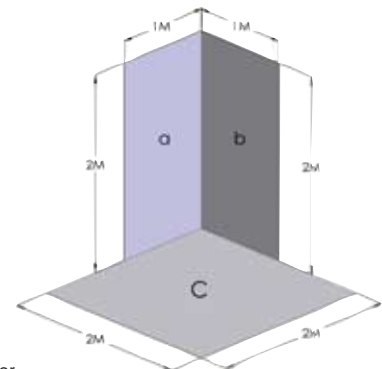

For our 9 Easy Steps Guide to installing a wetroom you can view a short video podcast guide at www.roman-showers.com or scan the QR code to view video directly on your smart phone



Tanking Kits

Roman Shield Tanking Kit 1: (Covers approx. 10m²)

Product Code	RSH01	Price ex vat	Price inc vat
Includes:		£322.51	£387.01
2ltr of Primer			
15m of Roman Shield Tape			
1 self-adhesive Shower Outlet Sleeve (drain mat)			
9kg of Roman Tanking Compound			
Installation Instructions & Guarantee Card			

Roman Shield Tanking Kit 2: (Covers approx. 10m²)

Product Code	RSH12	Price ex vat	Price inc vat
Includes:		£391.16	£469.39
RSH01 Tanking Kit 1 (see above)			
RSH02 Internal Corners x4			
RSH04 External Corners x2			
RSH06 Pipe Sleeves x2			

Glass Protection



“The ultimate Bathroom Protector on glass”

All Roman's enclosures and bath screens are pre-coated with Roman Ultra Care, our own unique glass protection system. Pre-coated glass protection systems will always diminish in their effectiveness over time, depending on how often the shower is used and how often it is cleaned. Unlike other systems, Roman Ultra Care in a bottle can be used in tandem with the pre-coat to build up the effectiveness and make it stronger the more you clean.

Roman Ultra Care is an award winning bathroom protector and has a 15 year track record for successfully protecting Roman's extensive product range. When applied to the glass of an enclosure or bath screen it creates a chemical barrier which provides protection against the build-up of grime, limescale and stains. The protective barrier means water glides off the glass with ease. This results in the protected surface remaining easy to clean by simply applying a mild detergent and wiping with a damp cloth or using a Roman Shower Blade.

By topping up the glass protection system with Roman Ultra Care in a bottle every time you clean, you can significantly reduce the amount of time required to clean your enclosure and bathroom surfaces. Most importantly, you can considerably prolong the life of your Roman product and at the same time do your bit for the environment by eliminating the use of harsh and damaging cleaning products.

As well as considering the environment during the manufacture of our products, we are also mindful of how our products can impact on the environment after they leave us. The addition of our Ultra Care Pre-coated Glass Protection means that dirt, grime and soap scum are washed away during the shower use. This means the use of harsh chemicals during the cleaning process can be eliminated and less water is required during the cleaning process.

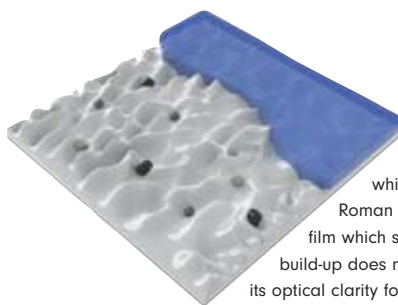

Simulation of glass surface magnified

All glass surfaces have a non smooth finish which can attract the build-up of particles. Roman Ultra Care provides an invisible protective film which seamlessly seals the surface to ensure this build-up does not bond to the glass and the glass retains its optical clarity for lasting sparkle.



House Beautiful AWARDS 2009
 Winner of the House Beautiful Best Cleaning Product Award 2009



Before coating

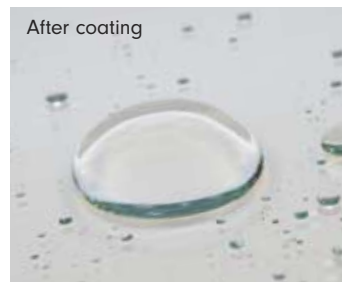

After coating

Ongoing After Care

To maintain the long lasting sparkle of your Roman enclosure or bath screen and aid the Ultra Care pre-coated glass protection; Roman Ultra Care can be purchased in a user friendly 750ml sized bottle. This can be purchased from your local Roman Bathroom Retailer, or alternatively from www.romanathome.com (UK only).

Roman Ultra Care is not limited to the cleaning and protection of your shower enclosure or bath screen, it can also be used to protect other bathroom surfaces, which are not pre-coated, including glass, tiles, aluminium frames, taps, trays, sinks and baths.

Simply wipe down your bathroom surfaces after use and apply Roman Ultra Care with a soft cloth.

Roman Ultra Care can be used weekly as part of your bathroom cleaning routine.

The more you apply Roman Ultra Care the more protection you create for your enclosure, therefore your enclosure will maintain its high quality finish for longer. Without using Roman Ultra Care, your pre-coated glass protection will diminish over time.

Important information to help you maintain your Roman product:

Ensure you clean your product using a mild detergent diluted in water and then polish off using a soft damp cloth. Apply a coat of Roman Ultra Care after each clean to build-up the protective film on the surface.

If you live in a hard water area, periodically clean your product using a 50/50 solution of white vinegar and water. The solution should be left on the enclosure for approximately 5 minutes then rinsed off using warm water.

1. Do not use acidic based products which are unsuitable for cleaning enamel surfaces.
2. Do not use abrasive cleaners or cleaners containing bleach or solvents, these products will adversely affect the finish of the aluminium profiles.
3. Do not use scouring pads, powder or any sharp instruments when cleaning your Roman enclosure.

RUC03 - 750ml Bottle code

£18.40 inc VAT
 (£15.33 ex VAT)

The above price is for consumers only
 (minimum quantity for stockists 12 bottles (RUC13))

For details of your nearest stockist please contact Roman Customer Relations on 01325 328033 or buy online at www.romanathome.com

Make cleaning your bathroom easy with our

Shower, Tile and Bath Restoration and Maintenance Kit

Restore discoloured glass and maintain the sparkle of your bathroom



“ Clean and protect your shower in minutes

Eliminates hard water and soap scum build-up”

RUC14 - Kit code

Only **£30.70** inc vat

(£25.58 ex VAT) per pack

The above price is for consumers only (minimum quantity for stockists 12 packs RUC15)

For details of your nearest stockist please contact Roman Customer Relations on 01325 328033 or buy online at www.romanathome.com

3 Step System includes:



Ultra Scrub

Surface Stain Cleanser

Designed to effectively and easily clean your bathroom surfaces, including Glass, Porcelain, Ceramics and other hard surfaces. Developed to remove the build-up of minerals, rust, soaps, oils and limescale but without damaging the surface.



Ultra Shield

Glass and Surface Stain Cleanser

Formulated to clean and protect. Ultra Shield can be used on your bathroom surfaces to create a water, soil and stain repellent barrier coating which prevents water, soil and grime from sticking for easier cleaning. This barrier is renewed with each use.



Ultra Care

Glass and Surface Protector

For a long lasting sparkle on bathroom and shower surfaces. Ultra Care is the ultimate surface protector that repels the build-up. Also available in large bottle for ongoing aftercare.

Protecting the Environment



Roman is totally committed to a very progressive environmental programme with ISO 14001 which targets waste reduction; improvement of resource efficiency; constant measurement and reviewing of environmental impact; and managing and improving environmental obligations.

Looking after the environment is an integral part of being a modern UK manufacturer and as a business we are continually striving for improvement and to exceed environmental targets - with the ultimate aim of becoming carbon neutral.

For more information on our environmental programme visit our dedicated environmental page on our website www.roman-showers.com



All waste is segregated into recyclables and non-recyclables. 93% of all waste is recycled - landfill reduced to 7% of total waste generated.



All Roman Shower Enclosures, Bath Screens and Trays are manufactured in the UK. All vehicles are Euro 6 compliant with our car fleet having average CO₂ emissions of 114 kg/km. Overall Roman have reduced the CO₂ emissions from business activity by 30% since 2009.



Roman brochures are printed on stock sourced from responsible forests.

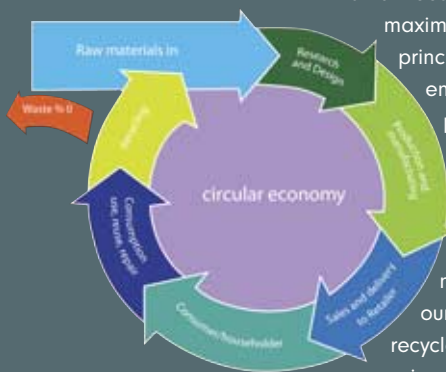

Roman is constantly working with our suppliers to maximise the use of recycled materials. The principles of the circular economy are embedded in all of our design and purchasing policies and plans. All Roman's aluminium and packaging is manufactured using 100% recycled material before we use it in our manufacturing process. All other materials used in the manufacturing of our products are also at high levels of recycled material. Our packaging is fully environmentally friendly with no wood or polystyrene used and is therefore itself 100% recyclable.

Recycling your product

Packaging

As an ISO14001 Registered Company, Roman takes recycling very seriously at all levels. All cardboard is already manufactured from recycled paper, but our packaging itself is designed for recycling. Please ensure that the cardboard packaging is taken to a local cardboard recycling point or to a local recycling depot.

End of Life (EOL)

EOL recycling is taken into account from the initial design stages to ensure all aspects of the Roman products can be recycled for future use. The Aluminium, Brass Alloys, Glass (and Solid Surface Material with Roman Stone Trays) can be easily recycled at your local Licensed Recycling Centre (LRC). If you are unable to access an LRC, then Roman can arrange to coordinate a pick-up of your product for a modest transport charge.

Roman's Bespoke Service allows you to build a made to measure shower enclosure, wetroom panel or bath screen, to perfectly suit your available space.

Roman offers a Bespoke Service on many of our products. So if you are looking to install a shower enclosure into an awkward or unusual space, we have the perfect solution. Roman's Bespoke Service allows you to tailor the height and width of your product, we have the option of clear, frosted or printed glass. Glass can be cut at an angle or shaped, for example angled glass can allow for a sloping roof, to make adding a showering facility to a loft conversion or under your stairs, easy.



- Made to measure items which fit almost anywhere
- All products made in accordance with your own measurements
- We endeavour to provide fast and efficient answers to all your questions
- Cost effective solutions
- Many designs to suit all tastes
- Measure and fit service available

Bespoke Services available:

- Reduced height
- Reduced width
- Clear, frosted or printed glass
- Angled/Shaped glass

To order a Bespoke Service all you have to do is simply choose which product you would like, then follow these six easy steps:

1. Take your drawings to your nearest retailer who will fax them to Roman. For your nearest retailer contact Roman Customer Relations on 01325 328033 or visit www.roman-showers.com
2. Roman will then send a quotation to your retailer for them to discuss with you
3. If you are happy with this quotation Roman will produce a drawing to illustrate what your final product will look like. Note: Roman will make all drawings in accordance to your measurements and unless otherwise requested, an adjustment allowance will be included. Please specify your adjustment allowance prior to ordering.
4. Roman will then fax the drawing to your retailer who will pass this on to you. This drawing will be in the form of a fax back agreement for you to sign*.
5. Once Roman receives the agreement work will begin on your product.
6. You will receive your product within 5-6 weeks.

*Once this agreement is signed you will be liable for any changes should you cancel your order.

For full pricing details and ordering process please go to:

www.roman-showers.com/roman-customers/available-downloads/

Consumer Guide

Roman shower enclosures have been tested and fully conform to the scope and relevant characteristics of BS EN14428:2015 (Shower Enclosures - Functional requirements and test methods), to meet the requirements of the mandate given under the EU Construction Product Directive (89/106/EEC).

As a result of full compliance to the directive and harmonized standard; Roman shower enclosures carry the 'CE' mark and are accompanied by a declaration of performance. (Available to view on www.roman-showers.com)

The CE marking indicates Roman shower enclosures conform to all essential requirements of European health and safety and environmental protection legislation. The conformity is mandatory, and allows Roman products to be legally placed on the market anywhere in the European Economic Area.

Additionally all Roman trays fully conform to EN14527:2016.

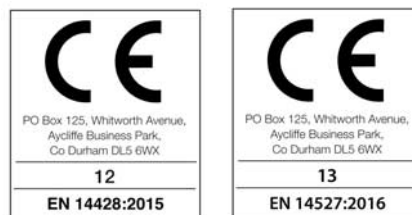

Important Product Details

- ◆ Enclosures and screens carry a Lifetime manufacturer's guarantee if products are installed according to the installation instructions - see guarantee criteria to the right.
- ◆ Simple and clear installation instructions are included with all Roman Products.
- ◆ Roman products are available for Virtual Worlds design service. For more information contact Roman Customer Relations on 01325 328033.
- ◆ Any guarantee variations are indicated separately.
- ◆ All guarantee forms supplied with installation instructions must be completed and returned to Roman within 60 days to validate the lifetime guarantee otherwise only a statutory 12 month guarantee will apply.
- ◆ All Roman Bath Screens and Enclosures are manufactured using toughened safety glass which complies to BSEN12150.
- ◆ All Roman Bath Screens and Enclosures are tested in accordance with BSEN14428 - shower enclosures, functional requirements and test methods.
- ◆ Roman's toughened glass is completely safe for use in our shower enclosures and bath screens; providing our products are installed according to our guidelines.
- ◆ It is important to note, that the glass must not be mounted or 'pinched' in such a way that would cause a stress point to develop in the glass. In addition, it must not be subjected to any sharp impact or severe temperature fluctuation which may also cause a stress point to develop in the glass.
- ◆ Roman's toughened glass is physically and thermally significantly stronger than standard glass. However a significant impact (or stress as outlined above) can cause toughened glass to break. In the event of breakage, toughened glass will break safely into small fragments in line with all relevant standards.
- ◆ All heights quoted for enclosures and bath screens are from the top of the shower tray or bath.
- ◆ All fixings are hidden on Roman products.
- ◆ The term "Silver" and "Nickel" describes the colour of the aluminium finish. No silver metal is included in any Roman products.
- ◆ All fixings and pivot pins are manufactured from stainless steel - this adds great strength and durability to Roman products.
- ◆ All seals and gaskets on Roman products are manufactured from colourless PVC.
- ◆ Roman over-bath products are not designed for baths with shaped or stepped fronts or integral soap dishes.
- ◆ The design rights of these products are owned by Roman Limited. All rights reserved.
- ◆ For compatibility of Roman enclosures with steam generators please contact Roman Customer Relations for advice on 01325 328033.
- ◆ Where indicated that products are suitable for use with steam generators, this refers to the performance of the product components. We do not however suggest that the product will have complete steam integrity.
- ◆ Due to the nature of wetroom panel products, water integrity cannot be guaranteed. Please consult your installer.

Guarantee

Roman Ltd. guarantees all Shower Enclosures and Bath Screens against faulty materials or manufacture for LIFE, provided they have been installed, used and maintained in accordance with our instructions.

All Roman product guarantees must be completed and returned within 60 days of purchase to validate the relevant guarantee. Failure to meet this deadline will result in a statutory 1 year guarantee on all products.

Should a claim arise, Roman Ltd. Customer Relations will investigate the issue. As part of this investigation we request that the following conditions be satisfied:

1. Proof of purchase at the time of the claim.
2. The guarantee applies to the original purchaser only and is non transferable.
3. The product has been fitted/installed in accordance with Roman Ltd. fixing instructions, local bylaws and general good plumbing practice
4. The product has been maintained and cared for in accordance with our instructions (including regular and appropriate cleaning).

If in our opinion the product has been modified, misused, neglected, wilfully or accidentally damaged, we can accept no responsibility for failure.

Roman Ltd. or its representatives must be given the opportunity to inspect the product in the installed condition.

Should any products included in the Lifetime guarantee be used for Commercial use i.e. leisure clubs, schools, hospitals, student accommodation, hotels or residential homes, only a 5 year guarantee will be applicable.

If in our opinion the product fails due to faulty materials or manufacture and that the conditions above have been met, Roman Ltd. will arrange for a specialist Roman Technical Sales Representative to repair or replace that item at our option.

Roman Ltd. believes in continuous improvement. If in our opinion the product has failed under the terms of the Guarantee and a replacement is offered but identical goods are no longer available, Roman Ltd. will replace it with our nearest equivalent product. For countries outside of the UK and Republic of Ireland, where a product has failed due to faulty materials or manufacture, a replacement product or product part will be offered only.

Should Roman Ltd. carry out work as a result of a claim but subsequently it is revealed that the product has been abused or improperly installed, we reserve the right to charge the customer for the expense incurred.

The liability of Roman Ltd. is limited to the product supplied by Roman Ltd. and does not extend to consequential loss or damage arising from the defective product.

This Guarantee, which is effective for products purchased after February 1st 2006, states our entire liability and is offered to customers acquiring our products as consumers, not in the course of trade or business. Ex displays or products reinstalled from their original position are not covered under this guarantee.

Non glass or metallic parts (e.g. seals) are subject to normal wear and tear through usage and are therefore covered on all products for 1 year from installation.

Roman Ultra Care pre-coat is not covered by this guarantee and it must be maintained by applying Ultra Care from a bottle on an ongoing basis.

Roman products not included in the lifetime guarantee include Roman Stone Shower Trays, Roman Accessories and Roman Shield® tanking products which are covered for 10 years. Roman Acrylic Capped Trays are covered for one year. Commercial projects with specific guarantee requirements can be subject to negotiation and agreement on a project by project basis. Any such agreements must be confirmed in writing prior to product supply or commencement in project works.

This guarantee does not affect your statutory rights.

This guarantee is wholly applicable in the U.K. and Republic of Ireland - export conditions as indicated

Roman Ltd
Whitworth Avenue, Aycliffe Business Park,
County Durham, DL5 6YN
Tel: 01325 311318 Fax: 01325 319889
www.roman-showers.com

UK:

Roman Limited,
Whitworth Avenue,
Aycliffe Business Park,
County Durham,
DL5 6YN,
England, UK.

General Reception:
Phone +44 (0) 1325 311318

UK Customer Relations:
Tel: +44 (0) 1325 328033
Email: custserv@roman-showers.com

UK Sales:
Tel: +44 (0) 1325 328034
Email: orders@roman-showers.com

International Sales/Customer Relations:
Tel: +44 (0) 1325 327740
Email: international@roman-showers.com
www.roman-showers.com/international

ASIA PACIFIC:

Roman Asia Sdn Bhd (091603K)
No.6, Jalan Olivin, Taman Industri Sungai Purun,
43500 Semenyih, Selangor, Malaysia

Asia Sales:
Tel: +60 (0) 3 8723 1211
Email: romanasia@roman-showers.com
www.roman-showers.com/international/roman-asia/

IRELAND:

W10F
Ladytown Business Park
Naas
County Kildare
Ireland

Ireland Sales:
Tel: +353 (0) 45 408 118
Email: irelandsales@roman-showers.com
www.roman-showers.com/international/roman-ireland-information/

www.roman-showers.com



FS 523822



EMS 523823

