



# SHOWER TRAYS AND ENCLOSURES







[www.tmuk.net](http://www.tmuk.net)



25mm LOW PROFILE SHOWER TRAYS / 10mm GLASS



# Contents

1	Introduction - Welcome
2 - 3	The Range - Our Shower Trays
 4 - 7	TM25 Linear
 8 - 11	TM25 Symmetry
 12 - 15	TM25 Elementary
 16 - 19	TM25 Anti-Slip (Symmetry & Elementary)
 20 - 24	TM25v Glass Enclosures
 25	Elementary Leg Set Advance



# LEADING INNOVATORS IN SHOWER TRAYS & ENCLOSURES

**Our shower trays are designed to look stylish,  
contemporary and to keep looking good for years.**

Clean lines, the best materials and clever use of technology combine to deliver the best shower trays and enclosures currently available. So whether you want a flush to floor wetroom

look without the challenges and expense of fitting an actual wetroom, or simply want a stylish alternative to a traditional shower tray, we have the products to meet your requirements.



+44 (0)1708 869 490

# WHICH IS THE BEST SHOWER TRAY FOR ME?

Whether you want an ultra-contemporary wet room look, a high grip surface, wheelchair access, to overcome a fitting restriction or simply require a cost effective stylish modern shower tray, we have the range for you.



## TM25 LINEAR

### RECOMMENDED USERS

For all families, elderly and less abled users.

### RANGE FEATURES

25mm high, 100% natural stone resin. Ultra modern Linear style wetroom alternative with flush fitted linear stainless steel waste cover (297mm x 75mm). Fitted as a standard shower tray with a simple flush to floor fitting option. Employs smart water technology which allows a virtually flat surface. Smallest water inlet aperture available featuring micro flow technology enabling drainage at approximately 30 litres per minute (vortex waste unit and cover included).

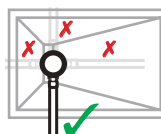

Waste location in the centre of shortest edge.  
High flow self-cleaning vortex waste unit.

**IMPORTANT INFORMATION:**  
PLUMBING OUTLET TO LEFT ONLY.



## TM25 SYMMETRY

### RECOMMENDED USERS

For all families, elderly and less abled users. Anti-slip option available.

### RANGE FEATURES

25mm high, 100% natural stone resin. Ultra modern central style wetroom alternative with flush fitted stainless steel waste cover (135mm x 135mm). Fitted as a standard shower tray with a simple flush to floor fitting option. Employs smart water management technology which allows a virtually flat surface yet drainage at over 30 litres per minute (vortex waste unit and cover included).

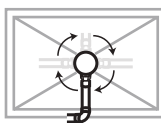

Waste location in the centre of the tray.  
High flow self-cleaning vortex waste unit.

360 Degree outlet plumbing option (joist location allowing).

# THE RANGE - OUR SHOWER TRAYS



## TM25 ELEMENTARY

### RECOMMENDED USERS

For all families and elderly. Anti-slip option available.

### RANGE FEATURES

25mm high 100% stone resin. Modern ultra low profile shower tray with unique 125mm x 125mm adjustable square waste cover in chrome plated ABS. Fitted with very low threshold entry (typical installation 10-15mm entry step). Employs traditional water management technology enabling drainage at approximately 28 litres per minute (vortex waste unit and cover purchased separately).

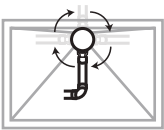

Waste location in centre of the longest edge.

360 degree plumbing option (joist location allowing).

FEATURES & BENEFITS	LINEAR	SYMMETRY	ELEMENTARY
Recommended for general family use	✓	✓	✓
Recommended for elderly users (*Elementary Anti-Slip version advised)	✓	✓	✓*
Recommended for less abled users/wheelchair access	✓	✓	
Contemporary wetroom style, fitted as a shower tray. No tanking or waterproofing required.	✓	✓	
Flush fitting stainless steel cover and vortex waste unit	✓	✓	
Virtually flat surface technology	✓	✓	
Smart water management technology	✓	✓	
Zero step access - Simple Flush to floor fitting option	✓	✓	
High grip Anti-Slip surface option		✓	✓
Simple standard shower tray fitting	✓	✓	✓
Can be fitted on all floor types	✓	✓	✓
Drains at approximately 30 litres per minute (*Elementary approx 28 litres)	✓	✓	✓*
Full lifetime guarantee	✓	✓	✓
100% natural stone resin - Fully recyclable	✓	✓	✓
Tough repairable gel coat surface	✓	✓	✓
360 degree waste outlet option (Joist location permitting)		✓	✓
Recommended for on or off the floor fitting. Simple leg set option			✓
Complies with EU274 standard for shower flow rates	✓	✓	✓
Designed and manufactured by hand in the UK	✓	✓	✓



+44 (0)1708 869 490

## STYLISH CONTEMPORARY SHOWER TRAY WITH LINEAR WASTE COVER

If you prefer the Classic look of a wetroom with a Linear outlet, this is the range for you.

Like the Symmetry range, the Linear has been designed for a broad range of users. It's flush to floor entry, flat surface and flush fitting waste cover (included) combine to minimise hazardous trip areas for young children and older people. Smart technology allows surplus water to be drawn from the surface preventing puddling and minimising the risk of slipping on soapy deposits. It also allows the tray to appear almost flat when fitted flush to the floor giving that all important wetroom look. The waste cover has also been designed to be fully load bearing which combined with smart surface technology gives easy access to wheelchair users. Unique to the range is smart

water capture technology enabling it to draw water from the tiny waste outlet at up to 30 litres per minute (vortex waste unit included). Everything has been considered, even the waste cover has been designed to minimise the possibility of damaging 'tiny toes'. Like the symmetry, it is a breakthrough in shower tray design offering the smart modern look of a wetroom for all the family but without the associated costs and fitting challenges. It is simply fitted as a shower tray, no tanking or waterproofing is required. Every aspect of it's ground breaking design benefits from the smart technology that allows it to function as well as it looks.



## THE TM25 LINEAR FEATURES & BENEFITS

- Linear wetroom look
- Available in 15 different sizes
- Ultra-low profile 25mm high with simple flush to floor fitting option
- Made from 100% natural stone resin. Fully recyclable
- Can be fitted on all types of floor
- Fitted as normal shower tray – no tanking or water proofing required
- Recommended for all users including; Elderly, less abled and young children
- Unique rectangular 297mm x 75mm stainless steel flush fitting waste cover (fully load-bearing)
- Dedicated high flow, self-cleaning vortex waste unit
- Smart water management technology
- Water removal tested to up to 30 litres per minute
- Step free access – no hazardous trip areas for young children and older people
- Smart virtual flat surface technology for maximised water drainage and that wetroom look
- Fully complies with EN274 European standard for shower flow rates
- Tough repairable gel coat surface
- Lifetime guarantee
- Suitable for wheelchair access
- Designed and made in the UK



+44 (0)1708 869 490



# Simple Flush Fitting Option

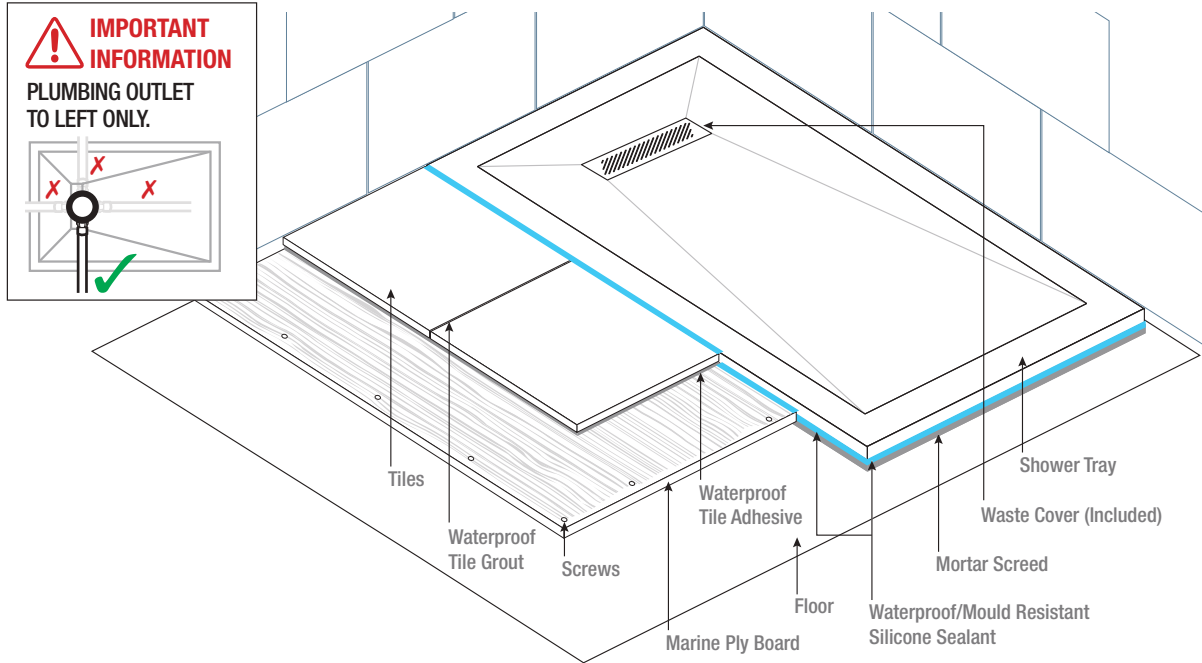

# Unique Smart Technology

Also featured in the Symmetry ranges, our virtual flat surface technology allows the tray to appear almost flat whilst leaving minimal water or soap deposits during showering.

Through advanced design, liquid is drawn from the surface and delivered at the correct velocity to a capture chamber beneath the waste cover. This ensures that the vortex waste unit is fed at the optimum rate allowing it to function at up to an incredible

30 litres per minute, keeping excess water and soap deposits to an absolute minimum. The waste unit has no moving parts and is entirely self-cleaning making this technology extremely reliable, much reducing the possibility of blockages.

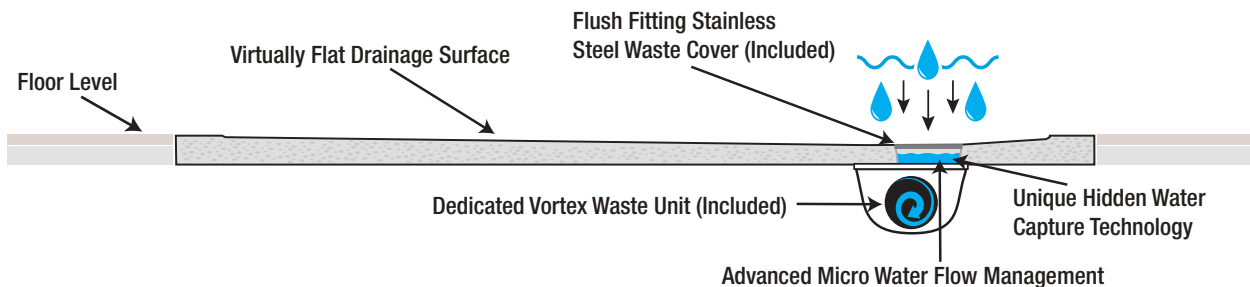

For full dimensions and specifications on the TM25 Linear range, visit:

[www.traymateproducts.com/linear-specs.pdf](http://www.traymateproducts.com/linear-specs.pdf)



# Smart Micro Water Capture Technology

Unique to the Linear is our micro water capture technology. Because of its striking design, the ultra narrow rectangular waste grid has a very small drainage aperture.

To allow the tray to drain at up to 30 litres per minute, water is collected in the tiny capture chamber and accelerated as it enters the vortex waste trap. Although only half of the size of the capture chamber in the Symmetry range, the Linear is capable of drawing water from it's surface at almost the same rate.

It took over 2 years for us to develop these revolutionary and unique technologies. Like much great design, the simplest of forms mask the true level of thought and understanding that lie behind them.

## SQUARE 25mm HIGH - LINEAR STONE RESIN SHOWER TRAY & WASTE/COVER (INCLUDED)



Size	Product Code	Price (inc. VAT)
900 x 900	L250900.SQ	£275.96

## RECTANGULAR 25mm HIGH - LINEAR STONE RESIN SHOWER TRAY & WASTE/COVER (INCLUDED)



Size	Product Code	Price (inc. VAT)
1000 x 800	L251000X800	£280.40
1000 x 900	L251000X900	£324.68
1200 x 760	L251200X760	£300.96
1200 x 800	L251200X800	£309.40
1200 x 900	L251200X900	£320.40
1400 x 800	L251400X800	£453.60
1400 x 900	L251400X900	£459.92
1500 x 800	L251500X800	£457.56
1500 x 900	L251500X900	£464.40
1600 x 800	L251600X800	£476.00
1600 x 900	L251600X900	£480.96
1700 x 800	L251700X800	£494.60
1700 x 900	L251700X900	£505.36

## QUADRANT 25mm HIGH - LINEAR STONE RESIN SHOWER TRAY & WASTE/COVER (INCLUDED)



Size	Product Code	Price (inc. VAT)
900 x 900	L250900.QUAD	£275.96



+44 (0)1708 869 490



# STYLISH, CONTEMPORARY SHOWER TRAY WITH CENTRALLY LOCATED WASTE COVER

If you prefer the timeless look of a wetroom with a central outlet, look no further than the Symmetry range.

Like the Linear range, the Symmetry has been designed for a broad range of users. It's flush to floor entry, flat surface and flush fitting waste cover combine to minimise hazardous trip areas for young children and older people. Smart technology allows surplus water to be drawn from the surface preventing puddling and minimising the risk of slipping on soapy deposits. It also allows the tray to appear almost flat when fitted flush to the floor giving that all important wetroom look. The waste cover (included) has also been designed to be fully load bearing which combined with smart surface technology gives easy access to wheelchair users.

Everything is considered, even the waste cover has been designed to minimise the possibility of damaging 'tiny toes'. Like the Linear, the Symmetry is a breakthrough in shower tray design offering the smart modern look of a wetroom for all the family but without the associated costs and fitting challenges. It is simply fitted as a shower tray, no tanking or waterproofing is required. Finally, if you choose our optional anti-slip surface, you can be sure of a lifetime of underfoot confidence when you shower. Every aspect of the Symmetry design benefits from the smart technology that allows it to function as well as it looks.



## THE TM25 SYMMETRY FEATURES & BENEFITS

- Centre waste wetroom look
- Available in 36 different sizes (Market leading Anti-Slip option available in 12 sizes)
- Ultra-low profile 25mm high with simple flush to floor fitting option
- Made from 100% natural stone resin. Fully recyclable
- Can be fitted on all types of floor
- Fitted as normal shower tray – no tanking or water proofing required
- Recommended for all users including; Elderly, less abled and young children
- Unique Square 135mm x 135mm stainless steel flush fitting waste cover (fully load-bearing)
- Dedicated High flow, self-cleaning vortex waste unit
- Smart water management technology
- Water removal tested to over 30 litres per minute
- Step free access – no hazardous trip areas for young children and older people
- Smart virtual flat surface technology for maximised water drainage and that wetroom look
- Fully complies with EN274 European standard for shower flow rates
- Tough repairable gel coat surface
- Lifetime guarantee
- Suitable for wheelchair access
- Designed and made in the UK



+44 (0)1708 869 490



# Simple Flush Fitting Option

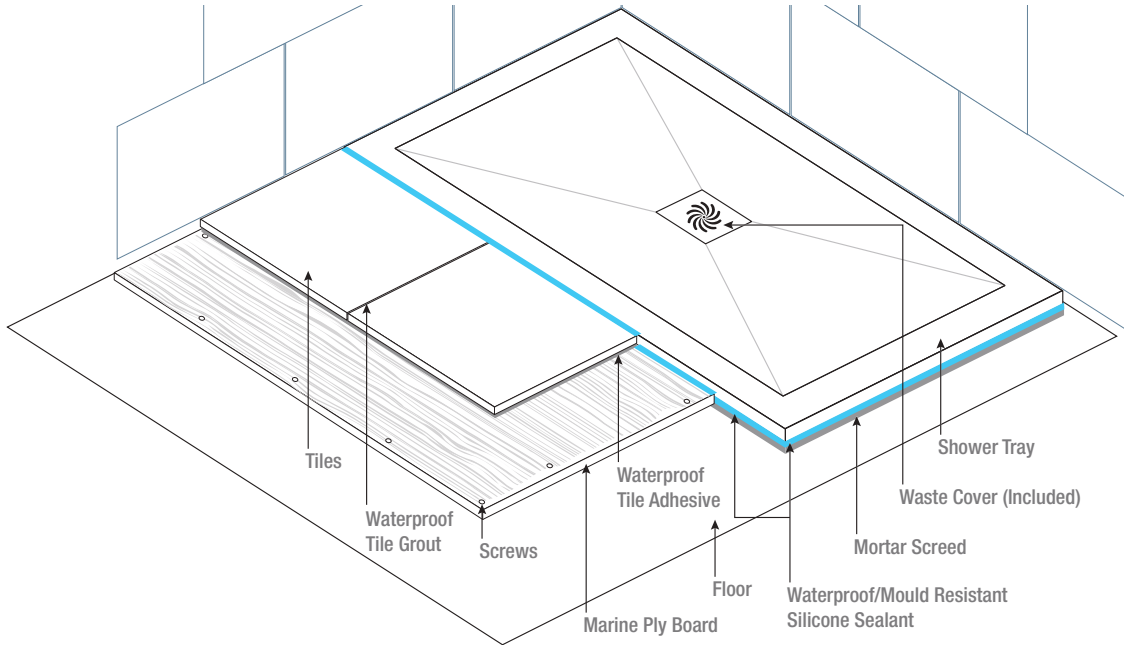

# Unique Smart Technology

Also featured in the Linear range, our virtual flat surface technology allows the tray to appear almost flat whilst leaving minimal water or soap deposits during showering.

Through advanced design, liquid is drawn from the surface and delivered at the correct velocity to a capture chamber beneath the waste cover.

entirely self-cleaning making this technology extremely reliable, much reducing the possibility of blockages.

This ensures that the vortex waste unit (included) is fed at the optimum rate allowing it to function at over an incredible 30 litres per minute, keeping excess water and soap deposits to an absolute minimum. The waste unit has no moving parts and is

It took over 2 years for us to develop this revolutionary and unique technology. Like much great design, the simplest of forms mask the true level of thought and understanding that lie behind them.

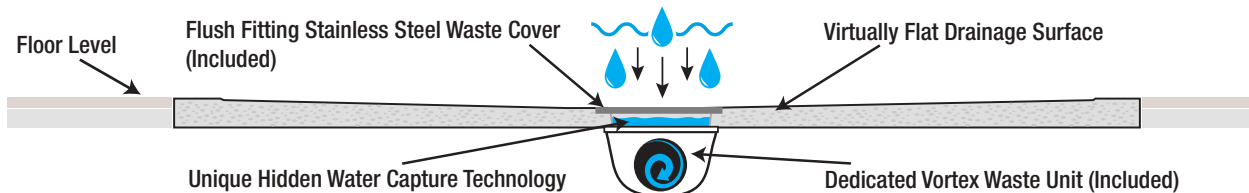

For full dimensions and specifications on the TM25 Symmetry range, visit:

[www.traymateproducts.com/symmetry-specs.pdf](http://www.traymateproducts.com/symmetry-specs.pdf)



[www.tmuk.net](http://www.tmuk.net)



## SQUARE 25mm HIGH - SYMMETRY STONE RESIN SHOWER TRAY & WASTE (INCLUDED)



Size	Product Code	Price (inc. VAT)
700 x 700	T250700.SQ	£208.00
760 x 760	T250760.SQ	£209.04
800 x 800	T250800.SQ	£223.12
900 x 900	T250900.SQ	£239.96
1000 x 1000	T251000.SQ	£350.40

## RECTANGULAR 25mm HIGH - SYMMETRY STONE RESIN SHOWER TRAY & WASTE/COVER (INCLUDED)

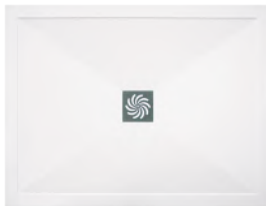

Size	Product Code	Price (inc. VAT)
900 x 760	T250900X760	£230.76
900 x 800	T250900X800	£235.84
1000 x 760	T251000X760	£240.92
1000 x 800	T251000X800	£243.84
1000 x 900	T251000X900	£246.32
1100 x 800	T251100X800	£248.96
1100 x 900	T251100X900	£254.68
1200 x 700	T251200X700	£259.88
1200 x 760	T251200X760	£261.72
1200 x 800	T251200X800	£269.04
1200 x 900	T251200X900	£278.60
1400 x 760	T251400X760	£382.68
1400 x 800	T251400X800	£394.44
1400 x 900	T251400X900	£399.92
1500 x 760	T251500X760	£391.92
1500 x 800	T251500X800	£397.88
1500 x 900	T251500X900	£403.84
1600 x 760	T251600X760	£405.28
1600 x 800	T251600X800	£413.92
1600 x 900	T251600X900	£418.24
1700 x 700	T251700X700	£420.56
1700 x 760	T251700X760	£422.68
1700 x 800	T251700X800	£430.08
1700 x 900	T251700X900	£439.44

## QUADRANT 25mm HIGH - SYMMETRY STONE RESIN SHOWER TRAY & WASTE/COVER (INCLUDED)



Size	Product Code	Price (inc. VAT)
800 x 800 Q	T250800.QUAD	£223.12
900 x 900 Q	T250900.QUAD	£239.96
1000 x 1000 Q	T251000.QUAD	£350.40

## OFFSET QUADRANT 25mm HIGH - SYMMETRY STONE RESIN SHOWER TRAY & WASTE/COVER (INCLUDED)



Right Hand (RH)



Left Hand (LH)

Size	Product Code	Price (inc. VAT)
1000 x 800 Q LH & RH	T251000X800.Q.LH or .RH	£318.72
1100 x 800 Q LH & RH	T251100X800.Q.LH or .RH	£319.96
1200 x 800 Q LH & RH	T251200X800.Q.LH or .RH	£338.96
1200 x 900 Q LH & RH	T251200X900.Q.LH or .RH	£378.48



+44 (0)1708 869 490



# STYLISH TRADITIONALLY DESIGNED SHOWER TRAY THAT HAS THE LOOKS TO LEAVE THE COMPETITION STANDING

If you are looking for a modern, ultra-low-profile shower tray that will continue to look great for years to come, but feel you don't need flush-to-the-floor fitting or that contemporary wetroom look, this is the range for you.

With its 25mm height, stylish good looks and ease of fitting, the Elementary leads the way in the traditional shower tray market. Look closer and you'll see the unique and ultra-modern adjustable square waste cover and the unique vortex waste unit (purchased separately) which removes water from the tray at over 28 litres per minute, faster than any comparable tray in its class. Want to fit the Elementary off of the floor? Simply use the unique and innovative optional Leg Set Advance kit (see page 25). What's more, our commitment

to innovation extends to the optional Anti-Slip surface of the tray (Also available in the Symmetry range). Rather than applying this after manufacture, we have developed a unique process to incorporate the anti-slip surface into the tray itself, ensuring a lifetime of confidence when you're in the shower, and doing away with the need to replace it.

Stylish, hard-wearing and easy to install, the Elementary is ideal for families of all ages.



## THE TM25 ELEMENTARY FEATURES &amp; BENEFITS

- Stylish, contemporary design which will look good for years
- Available in 34 different sizes (Market leading Anti-Slip option available in 29 sizes)
- Made from 100% natural stone resin. Fully recyclable
- Ultra-low profile 25mm high. Typical installation 10-15mm entry step
- Can be fitted on all types of floor or off of the floor with simple leg set option
- Recommended for general family. Elderly users advised to use Anti-Slip option
- Dedicated high flow waste unit (Not included - purchase separately)
- Unique ultra-modern adjustable square waste cover (Not included - purchase separately)
- Fully complies with EN274 European standard for shower flow rates
- Tough repairable gel coat surface
- Lifetime guarantee
- Water removal tested to 28 litres per minute
- Designed and made in UK



+44 (0)1708 869 490



## ULTRA LOW PROFILE

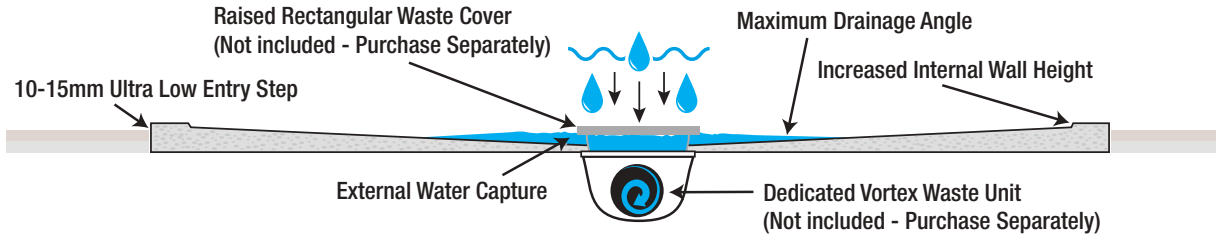

Only a 10-15mm entry step when fitted

## ADJUSTABLE WASTE COVER

(Waste and cover not included - purchase separately)

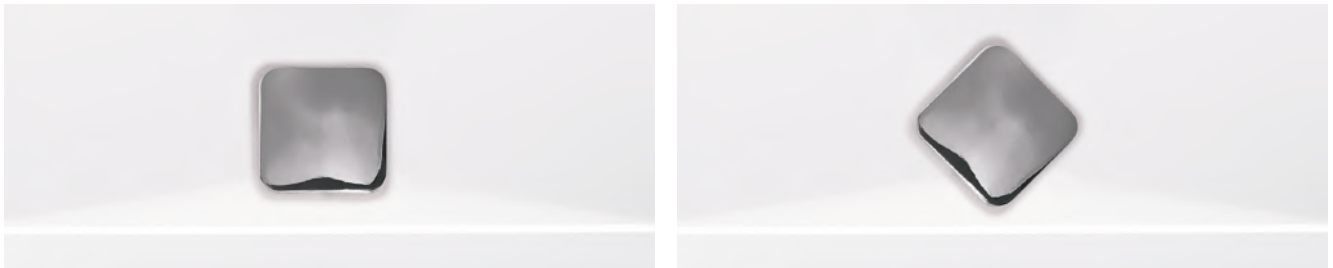

Unique adjustable waste cover offers a square or diamond fitting

## ELEMENTARY LEG SET ADVANCE

(See page 25)



Innovative leg system makes for simple off the floor fitting option

For full dimensions and specifications on the TM25 Elementary range, visit:

[www.traymateproducts.com/elementary-specs.pdf](http://www.traymateproducts.com/elementary-specs.pdf)



## SQUARE 25mm HIGH - ELEMENTARY STONE RESIN SHOWER TRAY & WASTE (PURCHASE SEPARATELY)



Size	Product Code	Price (inc. VAT)
700 x 700	D250700.SQ	£93.33
760 x 760	D250760.SQ	£93.30
800 x 800	D250800.SQ	£108.99
900 x 900	D250900.SQ	£116.30
1000 x 1000	D251000.SQ	£184.27
Waste and Cover	D25WASTE	£39.96

## RECTANGULAR 25mm HIGH - ELEMENTARY STONE RESIN SHOWER TRAY & WASTE (PURCHASE SEPARATELY)



Size	Product Code	Price (inc. VAT)
900 x 760	D250900X760	£145.14
900 x 800	D250900X800	£145.14
1000 x 760	D251000X760	£155.20
1000 x 800	D251000X800	£155.39
1000 x 900	D251000X900	£167.39
1100 x 800	D251100X800	£175.20
1100 x 900	D251100X900	£175.47
1200 x 700	D251200X700	£175.20
1200 x 760	D251200X760	£175.09
1200 x 800	D251200X800	£175.31
1200 x 900	D251200X900	£175.43
1400 x 760	D251400X760	£246.40
1400 x 800	D251400X800	£250.29
1400 x 900	D251400X900	£255.35
1500 x 760	D251500X760	£259.31
1500 x 800	D251500X800	£263.31
1500 x 900	D251500X900	£268.34
1600 x 800	D251600X800	£281.22
1600 x 900	D251600X900	£281.49
1700 x 700	D251700X700	£285.22
1700 x 760	D251700X760	£285.26
1700 x 800	D251700X800	£285.37
1700 x 900	D251700X900	£285.68
Waste and Cover	D25WASTE	£39.96

## QUADRANT 25mm HIGH - ELEMENTARY STONE RESIN SHOWER TRAY & WASTE (PURCHASE SEPARATELY)



Size	Product Code	Price (inc. VAT)
800 x 800 Q	D250800.QUAD	£144.50
900 x 900 Q	D250900.QUAD	£148.53
1000 x 1000 Q	D251000.QUAD	£175.39
Waste and Cover	D25WASTE	£39.96

## OFFSET QUADRANT 25mm HIGH - ELEMENTARY STONE RESIN SHOWER TRAY & WASTE (PURCHASE SEPARATELY)



Right Hand (RH)

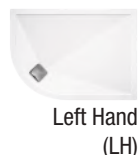

Left Hand (LH)

Size	Product Code	Price (inc. VAT)
1100 x 800 Q LH & RH	D251100X800.Q.LH or .RH	£174.74
1200 x 800 Q LH & RH	D251200X800.Q.LH or .RH	£189.45
1200 x 900 Q LH & RH	D251200X900.Q.LH or .RH	£197.37
Waste and Cover	D25WASTE	£39.96



+44 (0)1708 869 490



## INTRODUCTION

ANTI-SLIP TECHNOLOGY -  
FOR THE SAFER OPTION*Clever anti-slip surface technology for a lifetime of showering confidence*

Ideally suited to families with young children and those who just want to feel confident on their feet while in the shower, this unique patented technology ensures a lifetime of underfoot confidence when showering.

Unlike other anti-slip technologies which are applied on top of the surface of the tray after manufacture and wear away over time, our patented anti-slip surface is integrated directly into the shower tray at time of manufacture, meaning it never wears away and will last as long as the shower tray. What's more, because it's actually part of the tray's surface, cleaning it is as simple as cleaning the shower tray.

The TM25 Anti-Slip range offers a permanent guaranteed solution. When independently tested to the British standard 7976-2 slip test, the patent protected surface provided almost twice the bathroom industry standard of slip resistance.

The Anti-Slip option is available on selected sizes of the Elementary and Symmetry shower trays.

 **ELEMENTARY**  
**Anti-Slip**

The Elementary Anti-Slip. Added underfoot security from this modern ultra-low profile range which will continue to look good in your bathroom for years to come (Waste and cover purchased separately).



For full dimensions and specifications on the TM25 Elementary Anti-Slip range, visit:

[www.traymateproducts.com/elementary-specs.pdf](http://www.traymateproducts.com/elementary-specs.pdf)

 **SYMMETRY**  
**Anti-Slip**

A lifetime guaranteed Anti-Slip surface on the stylish Symmetry range. A wet room alternative without the associated costs or fitting challenges.



For full dimensions and specifications on the TM25 Symmetry Anti-Slip range, visit:

[www.traymateproducts.com/symmetry-specs.pdf](http://www.traymateproducts.com/symmetry-specs.pdf)

## THE TM25 ANTI-SLIP FEATURES &amp; BENEFITS

- Patent protected - Unique surface, built into the structure of the tray
- Market leading anti-slip rating – almost twice the industry standard
- Lifetime anti-slip guarantee. No need to repair or replace surface later
- Easy to clean surface
- Suitable for all users
- Suitable for all domestic applications, hotels and commercial contracts
- Comfortable under foot
- Dedicated high flow waste unit and adjustable cover (Not included - purchase separately)
- Designed and made in the UK



 **ELEMENTARY**  
*Anti-Slip*



+44 (0)1708 869 490



Size	Product Code	Price (inc. VAT)
700 x 700	DAS0700.SQ	£165.96
760 x 760	DAS0760.SQ	£168.00
800 x 800	DAS0800.SQ	£175.00
900 x 900	DAS0900.SQ	£183.49
1000 x 1000	DAS1000.SQ	£251.00

Size	Product Code	Price (inc. VAT)
900 x 760	DAS0900X760	£188.00
900 x 800	DAS0900X800	£189.00
1000 x 800	DAS1000X800	£196.28
1000 x 900	DAS1000X900	£206.00
1100 x 800	DAS1100X800	£207.00
1100 x 900	DAS1100X900	£209.00
1200 x 700	DAS1200X700	£216.00
1200 x 760	DAS1200X760	£210.00
1200 x 800	DAS1200X800	£211.14
1200 x 900	DAS1200X900	£218.68
1400 x 800	DAS1400X800	£346.98
1400 x 900	DAS1400X900	£351.81
1500 x 800	DAS1500X800	£350.01
1600 x 800	DAS1600X800	£364.09
1600 x 900	DAS1600X900	£367.91
1700 x 700	DAS1700X700	£408.00
1700 x 800	DAS1700X800	£409.40
1700 x 900	DAS1700X900	£432.00

Size	Product Code	Price (inc. VAT)
800 x 800 Q	DAS0800.QUAD	£175.00
900 x 900 Q	DAS0900.QUAD	£183.49
1000 x 1000 Q	DAS1000.QUAD	£251.00
1100 x 800 Q	DAS1100X800.Q.LH or .RH	£244.00
1200 x 800 Q	DAS1200X800.Q.LH or .RH	£260.00
1200 x 900 Q	DAS1200X900.Q.LH or .RH	£264.00
Waste & Cover	D25WASTE	£39.96

## TM 25 ELEMENTARY Anti-Slip

If you are looking for an anti-slip surface on a modern ultra low profile shower tray but don't need the flush to floor wet room look, this is the range for you.

With its 25mm height, stylish good looks and ease of fitting, the Elementary leads the way in traditional shower tray design. When fitted normally, there is a minimal entry step of 10-15mm making it the lowest threshold in it's class, keeping trip hazards to minimum. The unique patent protected surface, shared with the Symmetry Anti-Slip range is built into the tray and not applied separately. This ensures that no part of the anti-slip surface can be removed by wear or impact. It also offers the highest anti-slip factor available and is guaranteed for life. Want to fit the Elementary off of the floor? Simply use the unique and innovative optional Leg Set Advance (see page 25).

Stylish, hard wearing and easy to install, the Elementary Anti-Slip offers a lifetime of confidence when showering.

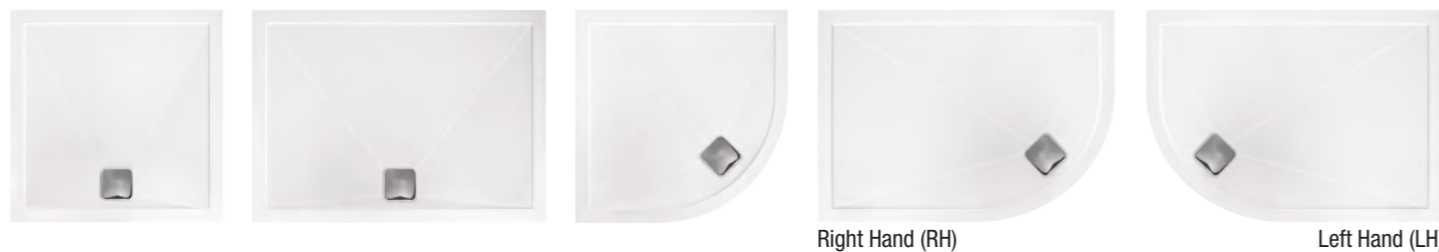
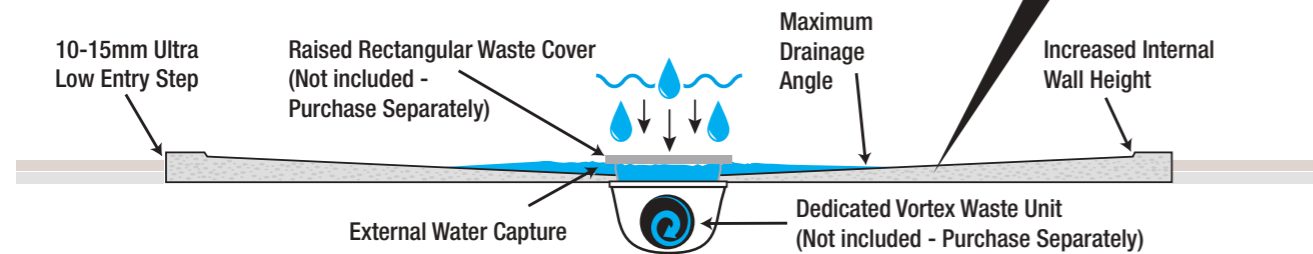
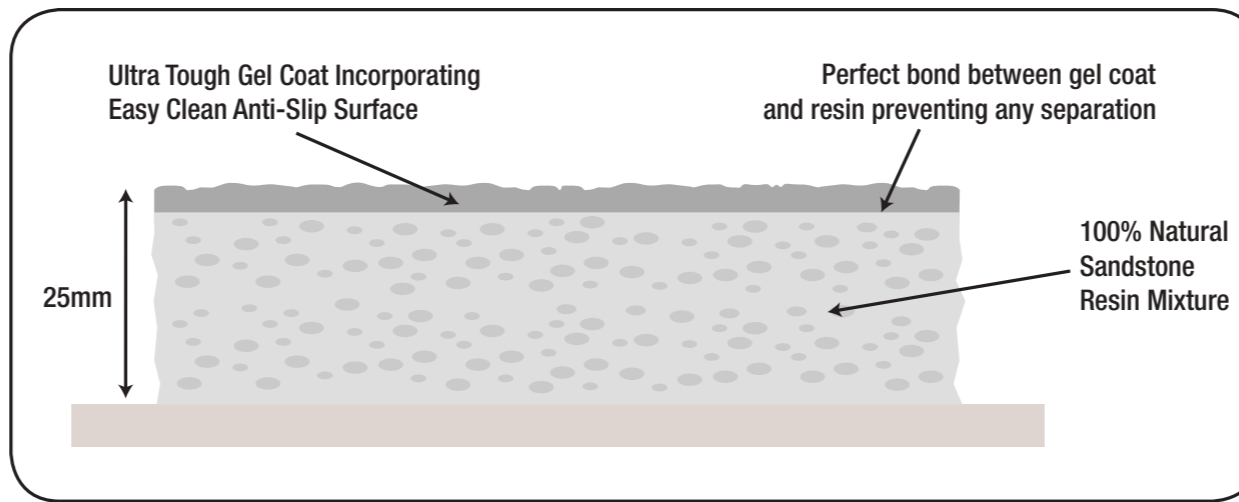

25mm HIGH - ELEMENTARY ANTI-SLIP STONE RESIN SHOWER TRAY & WASTE (PURCHASE SEPARATELY)

## TM 25 SYMMETRY Anti-Slip

For those who want the added security of permanent anti-slip combined with the timeless style of a wetroom, look no further than the Symmetry Anti-Slip range.

Like the Linear range, the Symmetry has been designed for a broad range of users. It's flush to floor entry, flat surface and flush fitting waste cover combine to reduce hazardous trip areas to zero. Smart technology helps draw surplus water and soapy deposits from the surface during showering. The waste cover is fully load bearing and combines with the unique flat surface technology to

give easy access to wheelchair users. All this, combined with the added security of a lifetime guaranteed anti-slip surface give the Symmetry Anti-Slip the credentials to be the safest range available on the market. The Symmetry is a breakthrough in shower tray design offering the smart modern look of a wetroom but without the associated costs and fitting challenges. It is simply fitted as a shower tray, no tanking or water proofing is required. Whatever your age, with the Symmetry Anti-Slip you can be sure of a lifetime of style and underfoot confidence whenever you shower.

Size	Product Code	Price (inc. VAT)
900 x 900	SAS0900.SQ	£275.95

Size	Product Code	Price (inc. VAT)
1000 x 800	SAS1000X800	£280.42
1200 x 800	SAS1200X800	£309.40
1200 x 900	SAS1200X900	£320.39
1400 x 800	SAS1400X800	£453.61
1400 x 900	SAS1400X900	£459.91
1500 x 800	SAS1500X800	£457.56
1600 x 800	SAS1600X800	£476.01
1600 x 900	SAS1600X900	£480.98
1700 x 800	SAS1700X800	£494.59
1700 x 900	SAS1700X900	£506.00

Size	Product Code	Price (inc. VAT)
900 x 900 Q	SAS0900.QUAD	£276.00

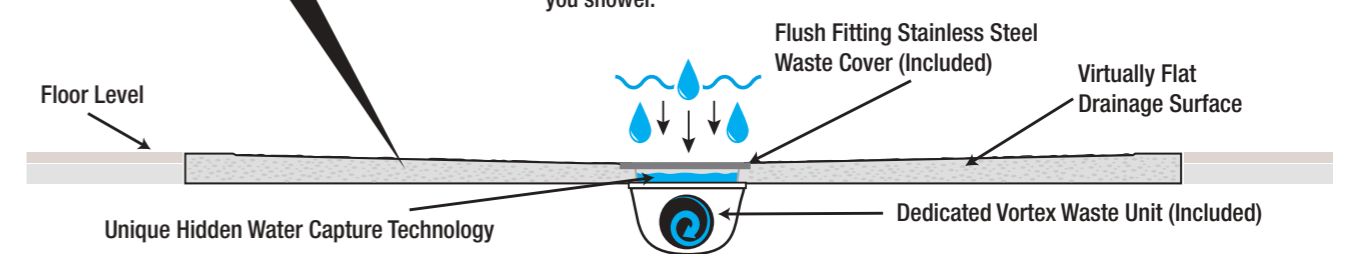

25mm HIGH - SYMMETRY ANTI-SLIP STONE RESIN SHOWER TRAY & WASTE (INCLUDED)

## REVOLUTIONARY IN DESIGN

The 2020 Vision glass enclosure range is designed to fit perfectly with all TMUK shower trays. 10mm thick toughened safety glass with easy clean technology, combined with strong, yet minimal chrome plated fixings to create the ultimate modern showering enclosure.



## THE TM25v FEATURES & BENEFITS

- 10mm highest quality toughened safety glass - 2020mm high (6ft6')
- Clean glaze protection coating
- Minimal yet strong high tensile steel wall fixings and bracketry finished in polished chrome
- Optional 300mm adjustable deflector panel (page 24)
- Comprehensive fitting instructions
- Lifetime guarantee on all items
- Suitable for all family, elderly, less abled, wheelchair access and commercial applications



+44 (0)1708 869 490



GLASS & FIXINGS



## GLASS PANELS & FIXINGS



	Size	Product Code	Price (inc. VAT)
GLASS PANEL (2020mm)	600	2020.600	£205.00
	700	2020.700	£220.00
	760	2020.760	£225.00
	800	2020.800	£236.00
	900	2020.900	£246.00
	1000	2020.1000	£258.00
	1100	2020.1100	£286.00
	1200	2020.1200	£298.00
	Deflector Panel	2020.DEFLECTOR	£170.00
FIXINGS	Front Fixing Kit	2020.FRONT.KIT	£86.00
	Side Fixing Kit	2020.SIDE.KIT	£86.00
	Corner Fixing Kit	2020.CORNER.KIT	£51.00
	Wall Post	2020.POST	£40.00

## CREATE YOUR OWN ENCLOSURES

Whatever enclosure design you require, you can create your own package. The basic required elements are the Glass, Wall Post and Fixing Kits. Below are some ideas for you to use as a building guide, simply create away.

### SAMPLE ENCLOSURE - A

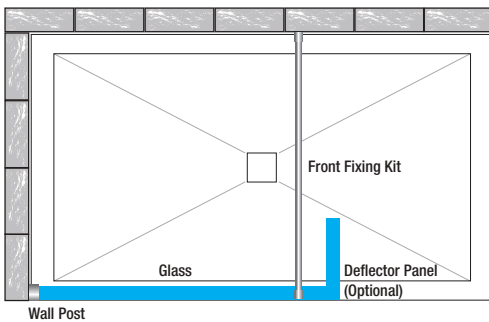

- Kit Contents:**
- Glass
  - Wall Post
  - Front Fixing Kit
  - Deflector Panel (Optional)

### SAMPLE ENCLOSURE - B

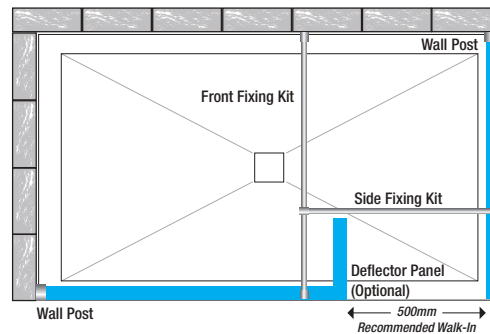

- Kit Contents:**
- Glass x 2
  - Wall Post x 2
  - Front Fixing Kit
  - Side Fixing Kit
  - Deflector Panel (Optional)

### SAMPLE ENCLOSURE - C

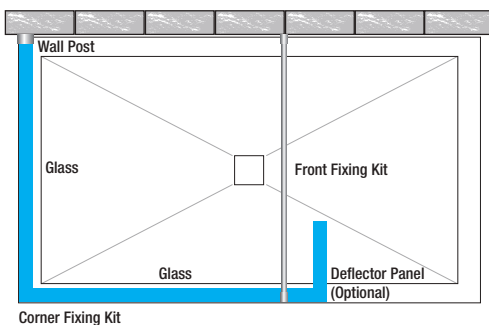

- Kit Contents:**
- Glass x 2
  - Wall Post
  - Corner Fixing Kit
  - Front Fixing Kit
  - Deflector Panel (Optional)

### SAMPLE ENCLOSURE - D

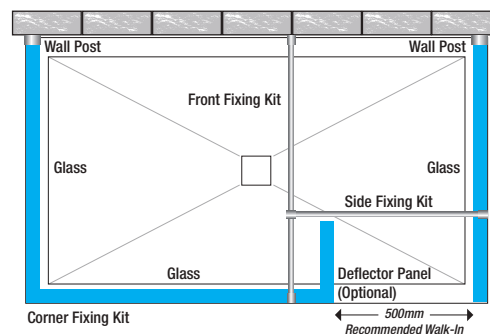

- Kit Contents:**
- Glass x 3
  - Wall Post x 2
  - Corner Fixing Kit
  - Front Fixing Kit
  - Side Fixing Kit
  - Deflector Panel (Optional)



+44 (0)1708 869 490





# DEFLECTOR GLASS

The deflector panel is an ideal and versatile extension to the TM25v 2020 Vision range.

Whether it be for additional water protection, an enclosure extension or simply for added versatility, this market leading 10mm toughened safety glass with easy clean glaze protection, can be positioned on a 180 degree axis - see illustration (A) Deflector - full entry/exit (B) Deflector (C) Glass extension.

The chrome plated hinges are all pre-fitted and can be attached to the 2020 Vision enclosure with ease.

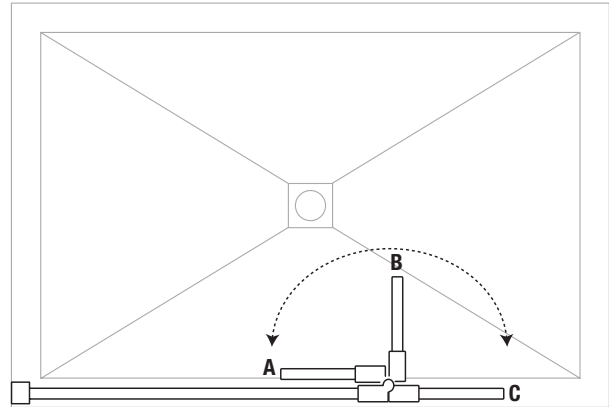

Illustration shows 180 degree axis of deflector panel

Size	Product Code	Price (inc. VAT)
Deflector Panel 2020 x 300 x 10	2020.DEFLECTOR	£170.00



# THE SIMPLEST SOLUTION

The Elementary Leg Set Advance is simplicity itself. Just fix the legs into position, level and lay the tray on top!

Adjusted in seconds, the legs combine together to create the flexibility to raise the tray from 90mm to 172mm from the floor surface allowing full access to the waste trap below.

Finished off with a high quality ABS acrylic capped fascia trim

panel(s). This kit is simple, yet engineered to last a lifetime. Each leg is capable of withstanding loads of over 400KG.

The Leg Set Advance kits are only available for the Elementary and Elementary Anti-Slip ranges.

Kit	Shower Tray Size	Product Code	Price (inc. VAT)	Legs	Fascia Panel
Kit A	760mm Square - 900mm Square	DLPA	£81.52	5 x Legs	2 x Panels
Kit B	1000mm Rectangular - 1200mm Rectangular	DLPB	£96.76	7 x Legs	2 x Panels
Kit C	1400mm Rectangular - 1700mm Rectangular	DLPC	£106.84	8 x Legs	2 x Panels
Kit D	800mm Quadrant - 900mm Quadrant	DLPD	£105.72	5 x Legs	1 x Panel
Kit E	1000mm Offset Quadrant - 1200 Offset Quadrant	DLPE	£116.96	6 x Legs	1 x Panel

Please visit [www.traymateproducts.com/fitkit-advance.pdf](http://www.traymateproducts.com/fitkit-advance.pdf) to see the correct fitting and leg placement.

**Kit includes:** Adjustable legs, acrylic fascia panel(s) and floor mounted fixing clips.











For instructions and specifications on the Fitting Kit Advance, visit:

[www.traymateproducts.com/fitkit-advance.pdf](http://www.traymateproducts.com/fitkit-advance.pdf)

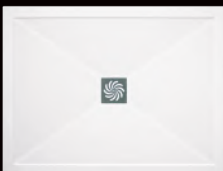

+44 (0)1708 869 490

# QUICK REFERENCE GUIDE THE TM25 SHOWER TRAY RANGE

 <b>LINEAR</b>	 <b>SYMMETRY</b>	 <b>SYMMETRY</b> <i>Anti-Slip</i>	 <b>ELEMENTARY</b>	 <b>ELEMENTARY</b> <i>Anti-Slip</i>
				
				
				
	 Right Hand (RH)		 Right Hand (RH)	 Right Hand (RH)
	 Left Hand (LH)		 Left Hand (LH)	 Left Hand (LH)
<b>SEE PAGE 4 - 7</b> FOR FULL DETAILS AND SIZES AVAILABLE	<b>SEE PAGE 8 - 11</b> FOR FULL DETAILS AND SIZES AVAILABLE	<b>SEE PAGE 16 - 19</b> FOR FULL DETAILS AND SIZES AVAILABLE	<b>SEE PAGE 12 - 15</b> FOR FULL DETAILS AND SIZES AVAILABLE	<b>SEE PAGE 16 - 19</b> FOR FULL DETAILS AND SIZES AVAILABLE

Please note:  
Prices are correct at time of printing. Please visit our website for current pricing.



**Traymate Products Limited (TMUK)**

Unit C19 - Ensign Estate, Botany Way, Purfleet, Essex RM19 1TB

Telephone  
01708 869 490

Fax  
01708 862 586

Email  
info@traymateproducts.com



Represented by

01708 869 490

Copyright © Traymate Products Limited, All rights reserved.

www.tmuk.net