

# BRISTAN

## Installation Instructions

Colonial Single Lever  
Easyfit Sink Mixer

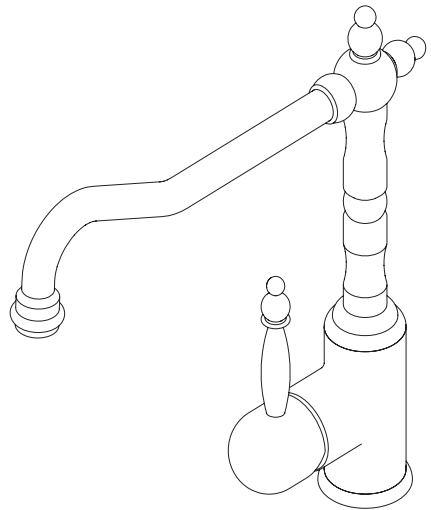

**Model covered:** K SNKSL EF C

Please keep this booklet for future reference.

Installer, when you have read these instructions please ensure you leave them with the user.



# Contents

Thank you for choosing Bristan, the UK's leading taps and showers expert.

We have designed this product with your enjoyment in mind. To ensure that it works to its full potential, it needs to be fitted correctly. These fitting instructions have been created to give you all of the information you need and, if you need any further help, please do not hesitate to contact us.

Important Safety Information.....	3
General Information .....	4
Specifications .....	4
Dimensions.....	5
Installation Requirements .....	6
Installation .....	7-8
Operation .....	9
Maintenance .....	10
Troubleshooting.....	11
Notes.....	12-13
Guarantee .....	14-15

# Important Safety Information

- Please read these instructions thoroughly and retain for future use.
- All products manufactured and supplied by Bristan are safe provided they are installed, used correctly and receive regular maintenance in accordance with these instructions.
- **If you are in any doubt about your ability to install this product safely you must employ the services of an experienced qualified plumber.**
- This fitting needs to be installed in accordance with, and meet the requirements of the Water Supply (Water Fittings) Regulations 1999 and Scottish Byelaws 2004.
- Remove all packaging and check the fitting for damage before starting installation.
-  **Warning:** Before starting any installation please consider the following: before drilling into walls, check that there are no hidden electrical wires, cables or water supply pipes. This can be checked with the aid of an electronic detector.
- If power tools are used do not forget to:
  - Wear eye protection
  - Unplug equipment after use
- **Important:** Remember to turn off the mains water supply before connecting to any existing pipe work. Fitting isolating valves to the inlet feeds is recommended for ease of maintenance.
-  **Warning:** Before installing the new fitting it is essential that you thoroughly flush through the pipework in order to remove any remaining swarf, solder, etc. Failure to carry out this procedure could cause problems or damage to the workings of the fitting.
- Take care when handling the 'flexible connecting pipes', do not bend, twist or crush them. Only tighten the pipes by hand.
- This product **must not** be modified in any way as this will invalidate the guarantee.

## General Information

This product has been tested to the Water Regulations Advisory Scheme (WRAS) and satisfies the requirements of the Water Supply (Water Fittings) Regulations 1999 and current bylaws. For full Installation Requirements & Notes (IRN) please visit [www.wras.co.uk/directory](http://www.wras.co.uk/directory).

Designed to comply with BS EN 200 for combination taps to be used within systems designed to BS 8558.

BS 8558 recommends hot water should be stored and distributed at a temperature of not less than 60°C which will minimise the build up of limescale in hard water areas.

If the fitting is installed at low pressure (tank fed), then the minimum distance from the highest installed position of the outlet to the underside of the cold tank should be at least 2 metres to ensure adequate performance.

This tap should be installed in compliance with the Water Regulations. Where the supplies are unbalanced, i.e. Hot water from cylinder tank / cold from the mains, approved check valves must be fitted in the supply pipes.

For further details contact your Local Water Authority.

## Specifications

Operating pressure range (bar)	Min	Max
	0.2	5.0
Maximum static pressure – 10.0 bar		

Inlet Connections: M10 1/2" BSP Flexible Tails with Isolation Valves

System Requirements:

Gravity fed hot & cold (Equal pressures)

Gravity fed hot & cold (Differential pressure, maximum ratio 5:1)

Unvented systems

Instantaneous water heater (Combination boiler)

# Dimensions

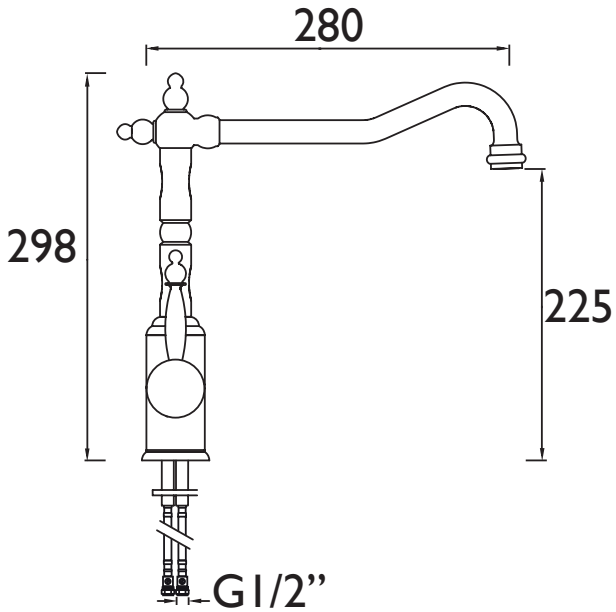

Dimensions are nominal and in millimetres.

**Need help?** Give us a call on 0844 701 6273 and speak to one of our trained advisers.

# Installation Requirements

## Flexible Connecting Pipes

Care must be taken when connecting the flexible connection pipes to the household pipework to ensure they do not bend sharply and kink or twist.

See below for recommended ways to fit the flexible connecting pipes.

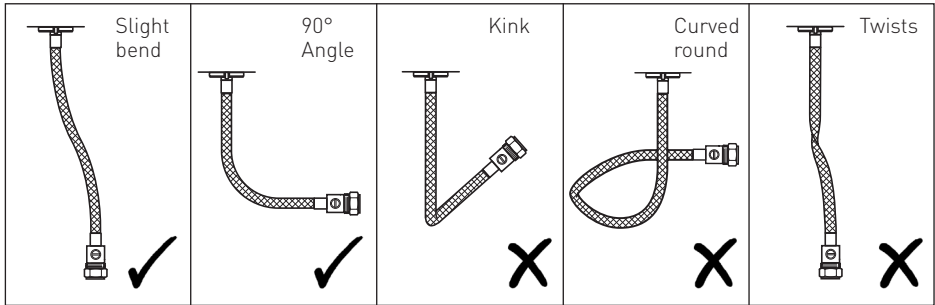

**⚠ Important:** Failure to follow these guidelines may result in poor performance and damage to the flexible connecting pipes.

**⚠ Important:** Full access must be made available on installation for future maintenance/ servicing purposes.

## Isolation Valves

The isolation valves must be accessible with a suitable flat-blade screwdriver for turning on and for future servicing purposes.

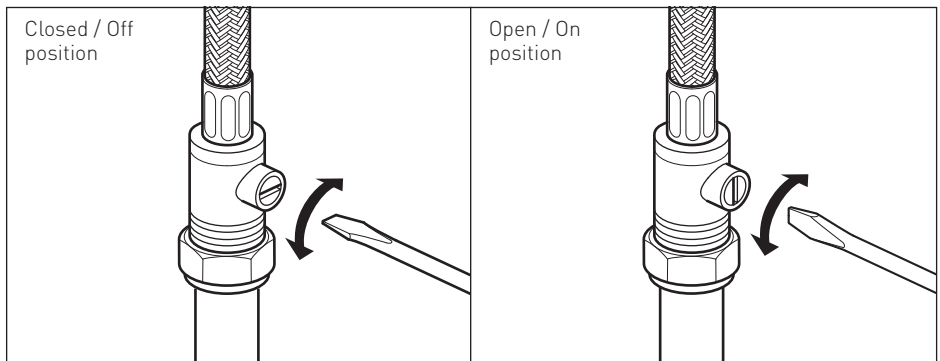

# Installation

## 1. Fit push-fit connector

Place the 'push-fit connector' into the hole in the basin top. Ensure the rubber washer is fitted to the underside.

## 2. Attach hot and cold connectors

Position the backnut under the basin (with the rubber seal on top), ensuring the locating pin fits into the hole in the backnut. Insert and loosely tighten the threaded cold connector by turning the 6mm hexagonal key clockwise.

Once threading has started you can let go of the backnut. Before fully tightening the cold connector, place the 'hot connector' into the push-fit connector - ensure it fits fully through the basin hole.

**Note:** The hot connector has 2 flat edges at the top to allow it to fit fully down and close to the top of the cold connector. Failure to do this may prevent the tap fitting onto the connector.

**⚠ Important:** The push-fit connector must be fully tightened to the back nut before attaching the flexible connecting pipes.

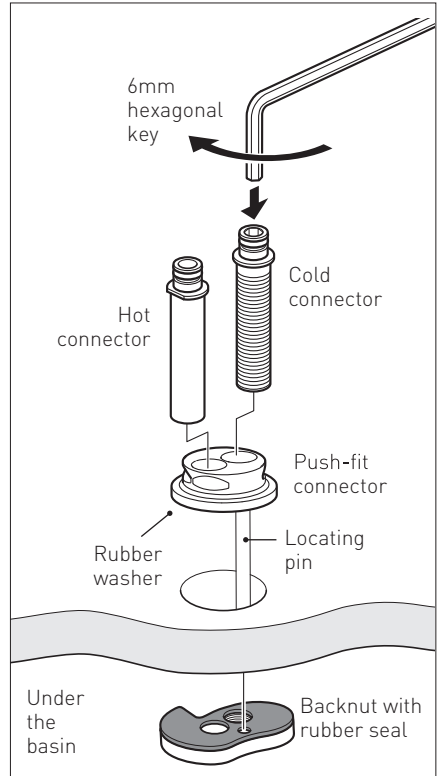

# Installation Cont.

## 3. Attach flexible connecting pipes.

**⚠ Important:** Before connecting the flexible connecting pipes, please refer to the specific installation requirements on page 6.

Carefully screw the 'flexible connecting pipes' into the 'push-fit connectors'. Fit the isolation valves (supplied) to the flexible connection pipes and turn to the 'closed' position as shown on page 6.

**Note:** A flexible connecting pipe can be fed up through the hot connector hole and then screwed on if required.

**⚠ Important:** Only tighten the flexible connecting pipe by hand. Do not overtighten. Connect the isolation valves/flexible connecting pipes to the household water supply pipes.

## 4. Cover cap

If required place the cover cap over the push-fit connector until the tap body is ready to be fitted.

## 5. Fit the tap body

Remove the cover cap and place the plinth over the push-fit connector. Grease the push-fit connector using the sachet of grease provided. Push-fit the tap body onto the connector. Align the body and tighten the grub screw at the rear of the body, using the long end of the 2.5mm hexagonal key as shown below until finger tight. Remove the hexagonal key and insert the short end into the grub screw and tighten an extra  $\frac{3}{4}$  to 1 complete turn more to ensure the tap body is securely tightened to the push-fit connector.

**⚠ Important:** The fitting must be securely attached to the base.

Turn on the mains water supply and open the isolating valves using a suitable flat blade screwdriver. (See page 6)

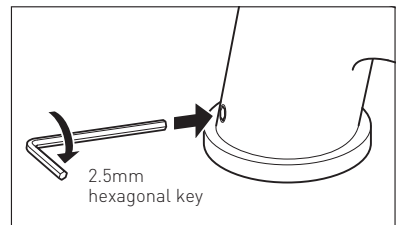
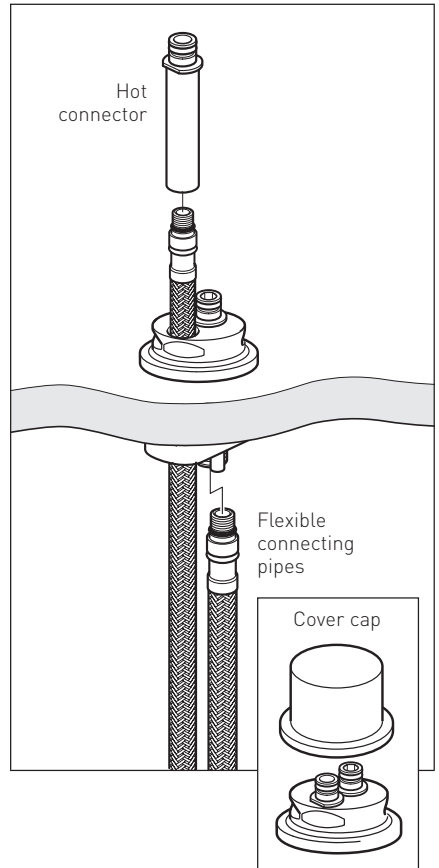

Tap body may vary to the one shown here



# Operation

## Temperature Control

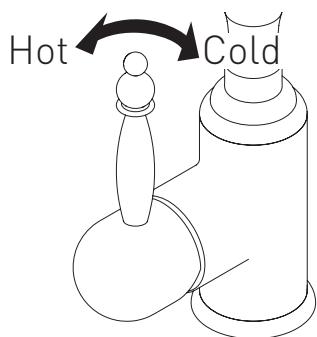

## Flow Control

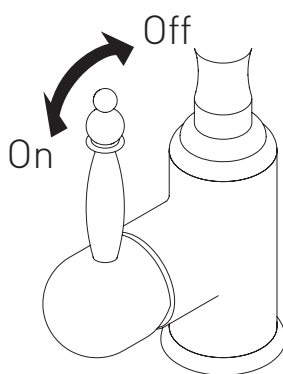

# Maintenance

## General Cleaning

Your fitting has a high quality finish and should be treated with care to preserve the visible surfaces. All surfaces will wear if not cleaned correctly, the only safe way to clean your mixer is to wipe with a soft damp cloth. Stains can be removed using washing up liquid. All bath cleaning powders and liquids will damage the surface of your fitting, even the non-scratch cleaners.

**Note:** Never use abrasive detergents or disinfectants or those containing alcohol, hydrochloric acid or phosphoric acid.

## Cleaning the Cartridge

Before carrying out any maintenance, turn off the mains water supply and close any isolating valves.

Unscrew the handle lever and loosen the grub screw. Remove the handle. Remove the shroud, cartridge retaining and the cartridge.

Clean the cartridge thoroughly under cold water to remove any build up of limescale or debris.

If necessary replace the cartridge using parts supplied by Bristan only.

Replace the cartridge, cartridge retaining nut and the shroud. Replace the handle, tighten the grub screw and screw the handle lever back in.

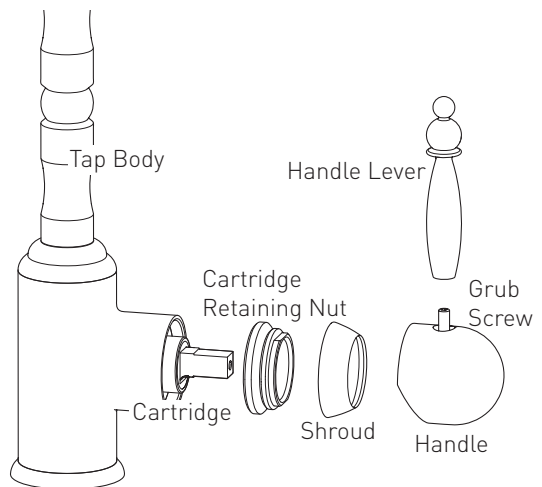

# Troubleshooting

Symptom	Cause	Remedy
No flow or low flow rate	Partially closed isolation valve.	Open isolation valve.
	Instantaneous water heater cycles on and off as flow rate or pressure is too low.	Increase water flow rate or pressure through system to meet required minimum working pressure of tap.
	Head of water is below the minimum distance required.	Refer to 'Specifications' on page 4.
	Hot or cold water being drawn off elsewhere causing pressure changes or instantaneous boiler temperature changes.	Do not use other water outlets when using the taps.
	Airlock or partial blockage in the supply pipework.	Flush through pipework to ensure removal of debris and any airlocks.
Water dripping from taps	This is normal for a short time after using the taps.	This is caused by capillary action, the build up of water in the tap body.
	If water continues to drip, possible build up of debris/ limescale in the cartridge.	Remove and clean the valve, refer to 'Maintenance' section on page 10 before removing the cartridge.
Taps do not turn on	Closed isolation valve.	Open isolation valve.
	Mains water supply turned off.	Turn on mains water supply.

# Notes

Please use this space to add any notes you or your installer may have regarding the plumbing system/ installation of this product.

# Notes

Please use this space to add any notes you or your installer may have regarding the plumbing system/ installation of this product.

# Guarantee

At Bristan, we want to make things as easy as possible for our customers. That's why we design products that are easy to fit and use, and that are quality tested to make sure they won't let you down. It's also why we offer solid guarantees on all products, effective from the date of purchase, to give you peace of mind.

Bristan's Bathroom Taps are covered by a **5 year guarantee**. This also includes **5 year labour cover** \* (subject to registration) which means that, in the unlikely event that there is a problem in the first year after purchase, we'll send one of our expert engineers to fix it.

\*Labour is provided by an approved Bristan Care engineer or appointed representative. The guarantee only applies to products with a manufacturing fault. There will be a call out charge for any incidents where no fault has been found with the product, or if the issue is due to poor installation or maintenance.

## Guarantee Terms and Conditions

This guarantee is in addition to your statutory and other legal rights and is subject to the following conditions:

- The product was purchased within the United Kingdom or Republic of Ireland.
- The guarantee applies solely to the original purchaser with proof of purchase.
- The installation must allow ready access to all products for the purpose of inspection, maintenance or replacement.

- Repair under this guarantee does not extend the original expiry date. The guarantee on any replacement parts or product ends at the original expiry date.

- Any part found to be defective during the guarantee period will be replaced without charge, providing that the product has been installed in accordance with the instructions given in this guide and used as the manufacturer intended.

The guarantee does not cover:

- Damage or defects caused by;
  - General wear and tear (including special non-chrome finishes; components such as filters, seals, 'O' rings and washers)
  - Incorrect installation
  - Repair using non-Bristan parts
  - Accidental or wilful misuse
  - Corrosion and the use of inappropriate cleaning products
  - System debris including the build up of limescale (which can be controlled through regular servicing and maintenance)
- Compensation for loss of use of the product or consequential loss of any kind.

In the interests of continuous product improvement, Bristan reserves the right to alter product specifications without notice.

The Bristan Product Guarantee does not affect your statutory rights as a consumer.

# Guarantee & Service Policy

## • Need help?

If this product does not function correctly when first used, contact **Bristan Care Customer Service on 0844 701 6273** where our expert team of advisors will be able to offer you help and advice.

## • Problems during the guarantee period

In the unlikely event that you encounter any problems with the product during the guarantee period, contact **Bristan Care Customer Service on 0844 701 6273** with your proof of purchase and we will work to resolve the problem quickly.

## **Bristan Care Customer Support**

Bristan customers also benefit from the support of Bristan Care, our comprehensive customer support package which offers:

### **Technical support hotline**

(Tel: 0844 701 6273) with access to fully trained advisers who can offer installation advice, talk you through quick maintenance checks, or recommend the best course of action to fix any problems with a product.

### **Expert advice**

Find easy to follow 'how to' video guides and technical FAQs online at [www.bristan.com](http://www.bristan.com). Our guides take you step-by-step through many product installations and you can find plenty of easy guides to quick product fixes and servicing.

## **Spare parts**

We hold thousands of spares and we keep them for discontinued products for over seven years. Spares can easily be ordered online at [www.bristan.com](http://www.bristan.com) and are dispatched the same day.

## **Expert plumbing engineers**

If we can't solve the problem over the 'phone or with a spare part, then we'll send out one of our Bristan Care engineers to take a look. Bristan Care engineers provide free support for products that are within guarantee, but are also available to service products that are out of guarantee for a small charge. For details, please call **Bristan Care Customer Service on 0844 701 6273**.

Part Number: K SNKSL EF C
Issue: D1

# BRISTAN

Bristan Group Ltd.  
Birch Coppice Business Park  
Dordon  
Tamworth  
Staffordshire  
B78 1SG  
Web: [www.bristan.com](http://www.bristan.com)  
Email: [enquire@bristan.com](mailto:enquire@bristan.com)

A Masco Company

## Useful contact details:

Customer Service:

**0844 7016273**

Customer Service Email:

**[Customercare@bristan.com](mailto:Customercare@bristan.com)**

Customer Service Fax:

**0844 7016275**

Reception:

**0844 7016274**

Join us on...

