

PRODUCT DATA SHEET



PRODUCT CODE

GL7000DNO+

RANGE

GLIDE II

DESCRIPTION

Basin Unit 700mm Nordic Oak

COLOUR	Nordic Oak
COLOUR CODE/ REFERENCE	Crosswater Exclusive
MATERIAL	16mm and 18mm MDF/MFC
STANDARDS	EN 13986 EN 14749
INSTALLATION TYPE	Wall-Mounted
DRAWER BOX	Textured Aluminium Anthracite Finish Concealed Runners
DRAWER RUNNERS	GRASS DWP XP - Soft Close, Pull to open
DRAWER EXTENSION	Full Extension
DRAWER ADJUSTMENT	4 Way
DRAWER CAPACITY	40kg
WALL HANGERS	CAMAR with Safety Lock - Factory Fitted 120kg Load Capacity Per Pair On A Solid Wall 3 Way Adjustment
ADJUSTABLE FEET	No
WEIGHT	28.88kg
WARRANTY	10 Years

TECHNICAL DIMENSIONS

Dimensions in mm unless otherwise specified.

Tolerances (per material type) apply.

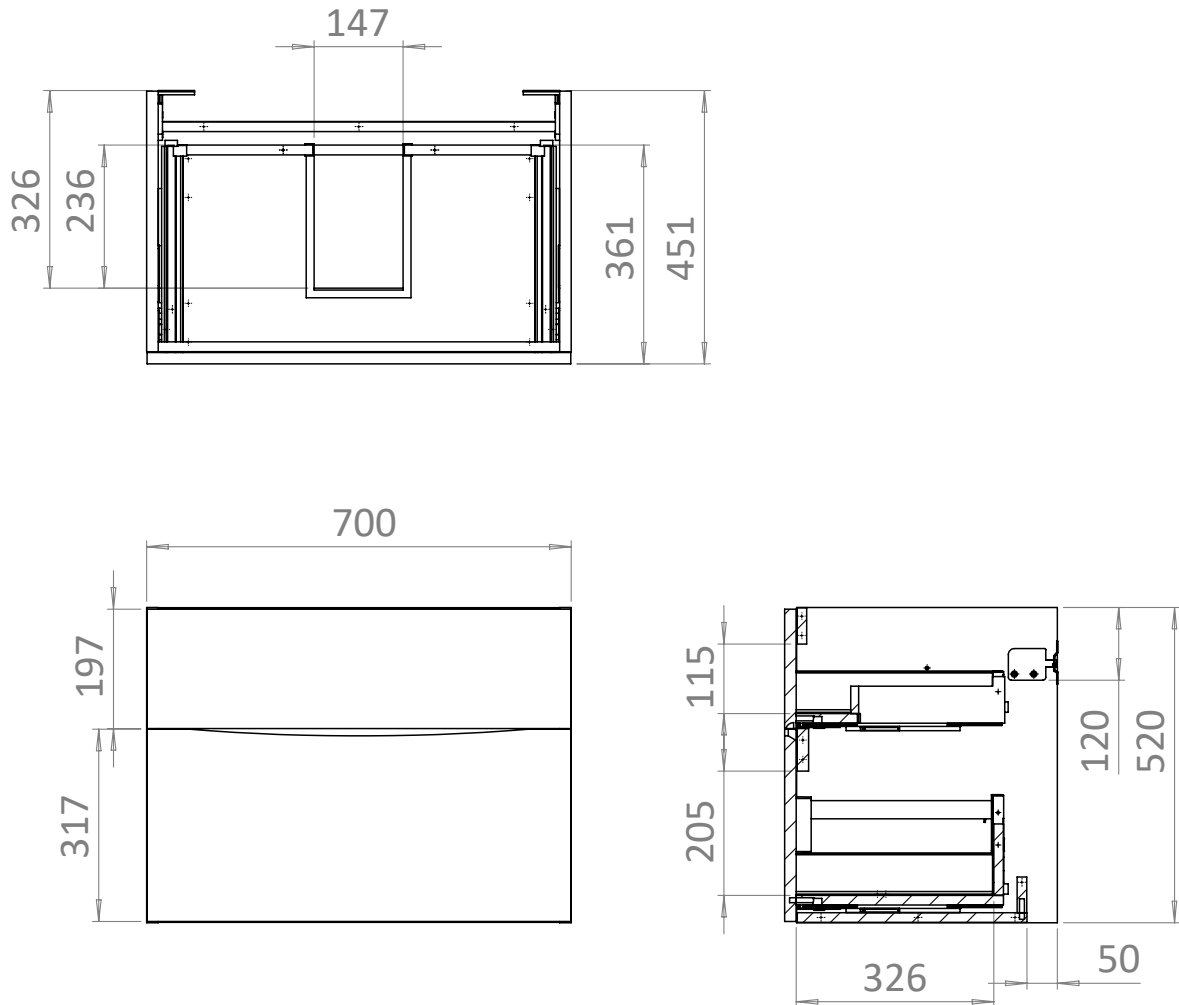

V10522

SPARES DIAGRAM

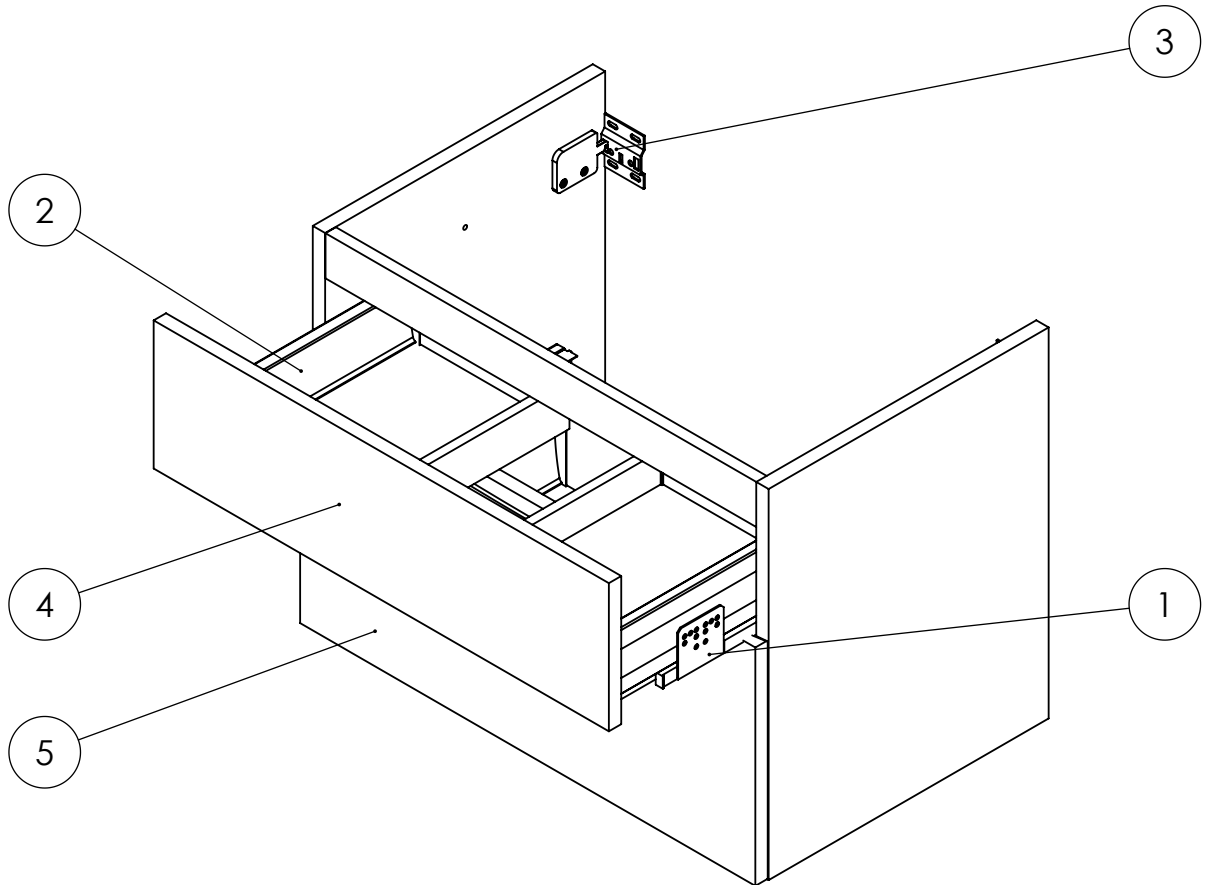

Only the parts labelled are available as spares.

V10522

SPARES DIAGRAM

NUMBER	PART CODE	DESCRIPTION
1	RUNNERS_GLIDE	Drawer Runners for Glide
2	GDCLIPS	Cover Caps for Side of Drawer Boxes
3	WB897ASZ16070	Wall Brackets
4	TDF_70GLDNO	Glide II 700 Top Drawer Front - Nordic Oak
	TDF_70GLDBS	Glide II 700 Top Drawer Front - Blue Smoke
	TDF_70GLDSG	Glide II 700 Top Drawer Front - Storm Grey
	TDF_70GLDWG	Glide II 700 Top Drawer Front - White Gloss
	TDF_70GLDWO	Glide II 700 Top Drawer Front - Windsor Oak
	TDF_70GLDST+	Glide II 700 Top Drawer Front - Steelwood
	TDF_70GLDBM	Glide II 700 Top Drawer Front - Matt Black
5	BDF_70GLDNO	Glide II 700 Bot Drawer Front - Nordic Oak
	BDF_70GLDBS	Glide II 700 Bot Drawer Front - Blue Smoke
	BDF_70GLDSG	Glide II 700 Bot Drawer Front - Storm Grey
	BDF_70GLDWG	Glide II 700 Bot Drawer Front - White Gloss
	BDF_70GLDWO	Glide II 700 Bot Drawer Front - Windsor Oak
	BDF_70GLDST+	Glide II 700 Bot Drawer Front - Steelwood
	BDF_70GLDBM	Glide II 700 Bot Drawer Front - Matt Black
	WGREPAIR	Touch Up Kit White Gloss
	BSREPAIR	Touch Up Kit Blue Smoke
	SGREPAIR	Touch Up Kit Storm Grey
	BMREPAIR	Touch Up Kit Matt Black

Only the parts labelled are available as spares.

V10522