

Sales Code: H010

Description: Knurled Bar Handle 96mm Centres

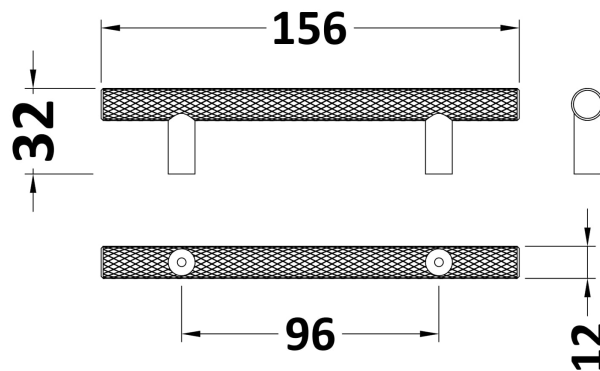

Product Dimensions

| | |
|-------------------|------|
| Length (mm): | |
| Width (mm): | 16 |
| Height (mm): | 155 |
| Depth (mm): | 36 |
| Nett Weight (kg): | 0.01 |

Packaging Dimensions

| | |
|--------------------|------|
| Height (mm): | 220 |
| Width (mm): | 1 |
| Depth (mm): | 1 |
| Gross Weight (kg): | 0.01 |

Packaging Data

| | |
|---------------|-------------|
| Box Colour: | Polybagged |
| Box Qty: | 1 |
| Label Size: | 100 x 50 |
| Label Colour: | White Label |
| Label Qty: | 1 |

Outer Box Dimensions (If Applicable)

| | |
|--------------------|---------------|
| Height (mm): | |
| Width (mm): | |
| Length (mm): | |
| Depth (mm): | |
| Gross Weight (kg): | |
| Barcode: | 5056211899082 |

Product Details

| | |
|--------------------------|----------------|
| Country of Origin: | China |
| Fitting Instruction: | No |
| CE & UKCA: | N/A |
| Product Material: | Brass |
| Heating Element Wattage: | Not Applicable |
| Colour/Finish: | |
| Product Diameter: | 16 mm |
| Connection Size: | 96mm Centres |