

**STRAIGHT PIVOT / BIFOLD DOORS**

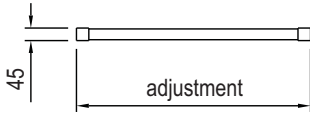

ADJUSTMENT mm		
PRODUCT SIZE	RECESS door only	CORNER door + 1 side panel
760 Pivot / Bifold	705 - 745	732 - 752
800 Pivot / Bifold	745 - 785	772 - 792
900 Pivot / Bifold	845 - 885	872 - 892
1000 Pivot-Wide	945 - 985	972 - 992
1100 Pivot-Wide	1045 - 1085	1072 - 1092
1200 Pivot-Wide	1145 - 1185	1172 - 1192

**STRAIGHT SLIDER DOORS**

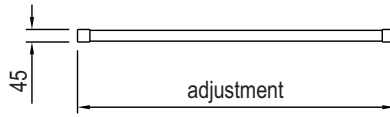

ADJUSTMENT mm		
PRODUCT SIZE	RECESS door only	CORNER door + 1 side panel
1000 Slider	945 - 985	972 - 992
1100 Slider	1045 - 1085	1072 - 1092
1200 Slider	1145 - 1185	1172 - 1192
1400 Slider	1345 - 1385	1372 - 1392
1500 Slider	1445 - 1485	1472 - 1492
1600 Slider	1545 - 1585	1572 - 1592
1700 Slider	1645 - 1685	1672 - 1692

**BOWED PIVOTS / SLIDER**

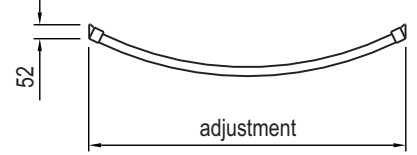

ADJUSTMENT mm		
PRODUCT SIZE	RECESS door only	CORNER door + 1 side panel
800 Pivot	755 - 785	775 - 790
900 Pivot	855 - 885	875 - 890
1200 Pivot / Slider	1145 - 1175	1165 - 1180
1500 Slider	1445 - 1475	1465 - 1480
1700 Slider	1630 - 1660	1650 - 1665

**STRAIGHT CORNER SLIDER**

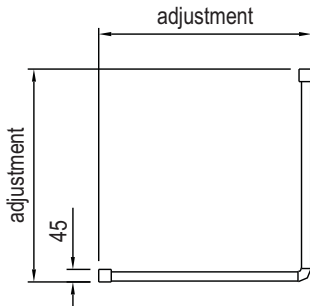

ADJUSTMENT mm	
PRODUCT SIZE	CORNER ENCLOSURE
760	725 - 745
800	765 - 785

**CURVED SLIDERS / PIVOTS**

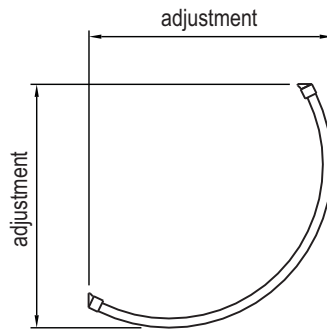

ADJUSTMENT mm	
PRODUCT SIZE	CORNER ENCLOSURE
810 Curved	780 - 795
910 Curved	880 - 895
1000 Curved	970 - 985
1000 x 810 Offset	970 - 985 / 780 - 795
1200 x 910 Offset	1170 - 1185 / 880 - 895

**OFFSET CURVED SLIDER / PIVOT**

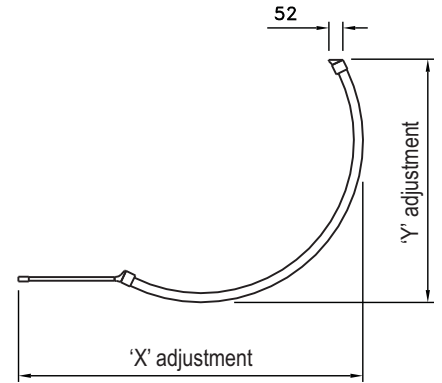

ADJUSTMENT mm	
PRODUCT SIZE	CORNER ENCLOSURE
1270 Offset Pivot	'X' 1240 - 1260
	'Y' 880 - 895
1270 Offset Slider	'X' 1245 - 1260
	'Y' 880 - 895

**PENTAGRA ENCLOSURE**

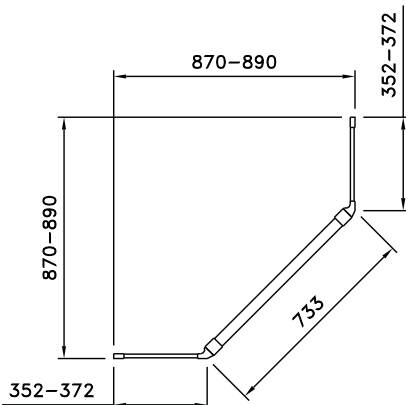

**CURVED QUADRANT PIVOT**

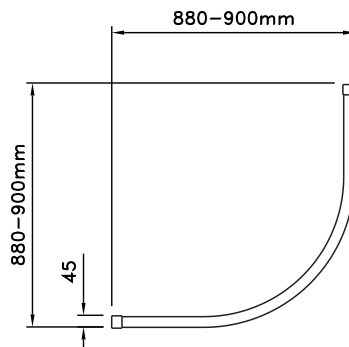

**ENCLOSURE PANELS**

STANDARD

SPECIAL



ADJUSTMENT mm	
PRODUCT SIZE	SIDE PANEL
700 Special Side Panel ( <i>Bowed Doors Only</i> )	685 - 700
800 Special Side Panel ( <i>Bowed Doors Only</i> )	785 - 800
700 Standard Side Panel	672 - 687
760 Standard Side Panel	732 - 747
800 Standard Side Panel	772 - 787
900 Standard Side Panel	872 - 887

**CENTRE FOLDING DOOR**

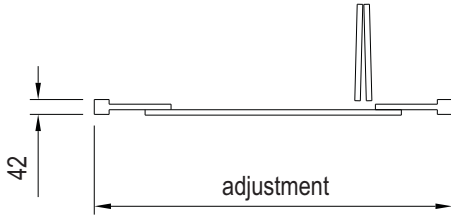

ADJUSTMENT mm			
PRODUCT SIZE	RECESS door only	CORNER door + 1 side panel	PENINSULAR door + 2 side panels
760	725 - 765	731 - 751	737
800	765 - 805	771 - 791	777
900	865 - 905	871 - 891	877
1000	965 - 1005	971 - 991	977
1200	1165 - 1205	1171 - 1191	1177

**STRAIGHT HINGED / SLIDER DOORS**

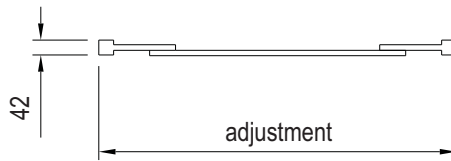

ADJUSTMENT mm			
PRODUCT SIZE	RECESS door only	CORNER door + 1 side panel	PENINSULAR door + 2 side panels
800 Hinged	765 - 805	771 - 791	777
900 Hinged	865 - 905	871 - 891	877
1000 Hinged	965 - 1005	971 - 991	977
1200 Hinged / Slider	1165 - 1205	1171 - 1191	1177
1500 Hinged / Slider	1465 - 1505	1471 - 1491	1477
1700 Slider	1665 - 1605	1671 - 1691	1677

**BOWED HINGED / SLIDER DOORS**

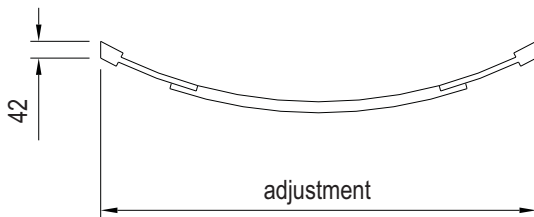

ADJUSTMENT mm			
PRODUCT SIZE	RECESS door only	CORNER door + 1 side panel	PENINSULAR door + 2 side panels
1200 Hinged / Slider	1170 - 1205	1172 - 1189	1174
1500 Slider	1470 - 1505	1472 - 1489	1474
1700 Slider	1655 - 1690	1657 - 1674	1659

**CURVED SLIDER ENCLOSURES**

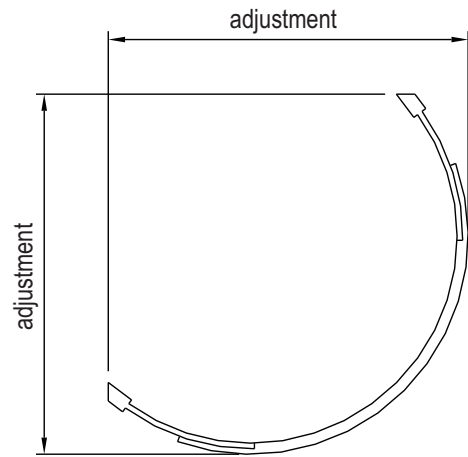

ADJUSTMENT mm	
PRODUCT SIZE	CORNER ENCLOSURE
910 Curved	880 - 897
1000 Curved	970 - 987
1000 Offset Curved	780 - 797 / 970 - 987
1200 Offset Curved	880 - 897 / 1170 - 1187

**1200 PENINSULAR SLIDER ENCLOSURE**

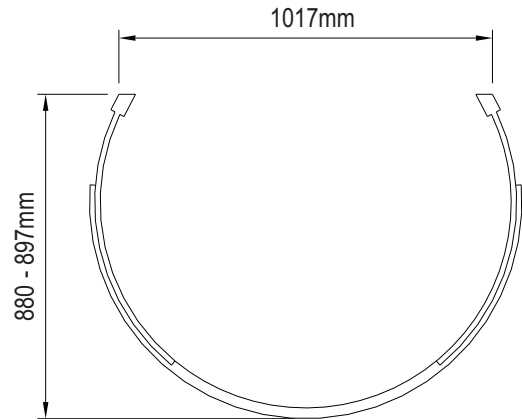

**ENCLOSURE PANELS**

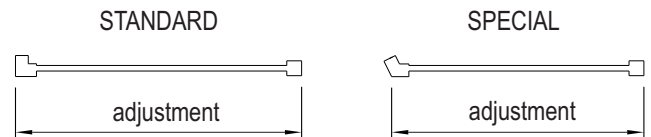

ADJUSTMENT mm	
PRODUCT SIZE	SIDE PANEL
700 Special Side Panel (Bowed Doors Only)	678 - 698
760 Standard Side Panel	731 - 751
800 Standard Side Panel	771 - 791
900 Standard Side Panel	871 - 891
1000 Standard Side Panel	971 - 991
1200 Standard Side Panel	1171 - 1191

PRODUCT Glass Panel (nominal size)	PRODUCT CODE	DIMENSIONS mm			
		A	B Actual Glass Width	C	D
600	5WP600	562 - 582	555	572 - 592	29
700	5WP700	662 - 682	655	672 - 692	29
760	5WP760	722 - 742	715	732 - 752	29
800	5WP800	762 - 782	755	772 - 792	29
900	5WP900	862 - 882	855	872 - 892	29
1000	5WP1000	962 - 982	955	972 - 992	29
1100	5WP1100	1062 - 1082	1055	1072 - 1092	29
1200	5WP1200	1162 - 1182	1155	1172 - 1192	29
1400	5WP1400	1362 - 1382	1355	1372 - 1392	29

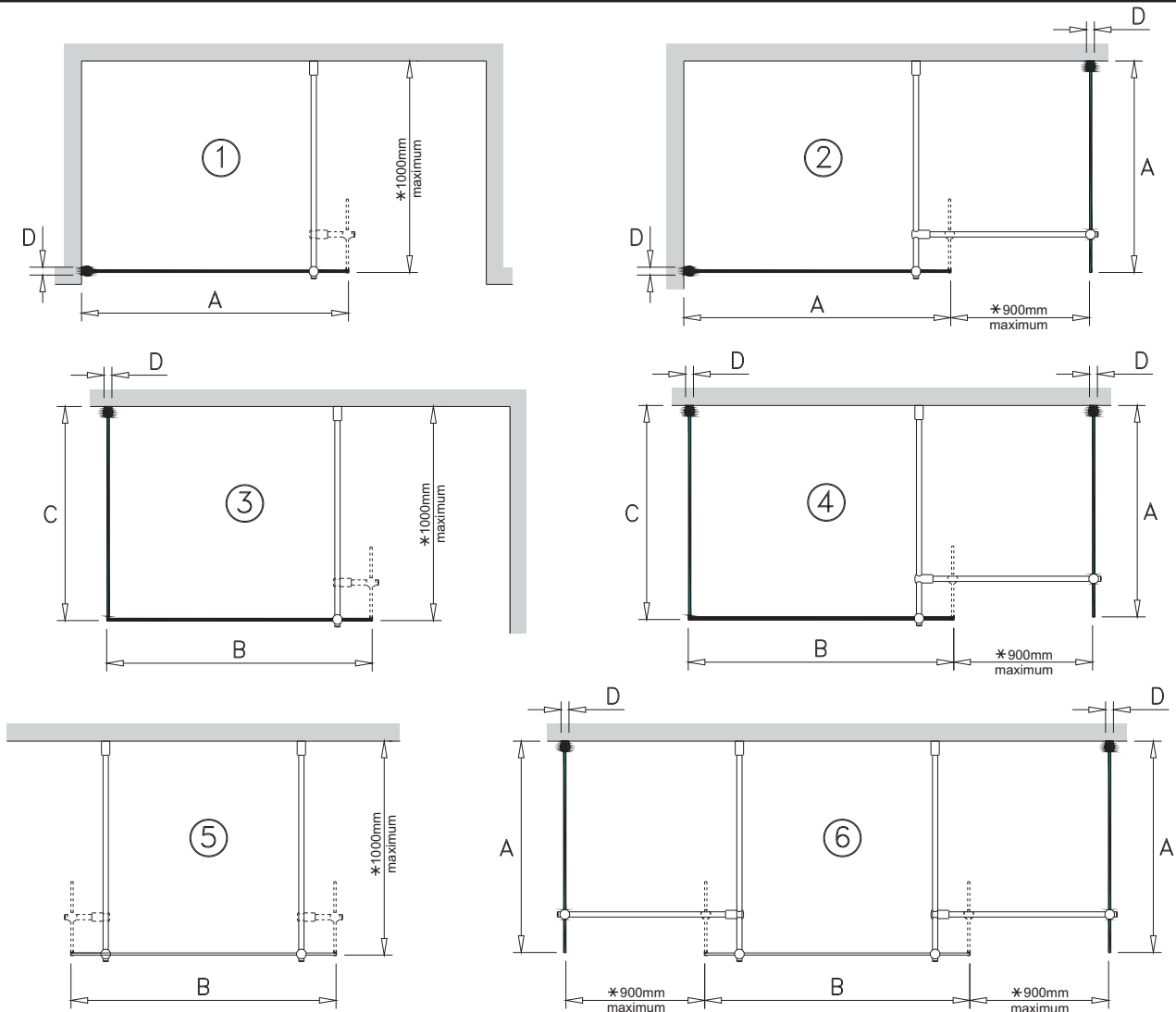

All panels are unhandled and can be installed to give left-hand and right-hand access.  
For clarity purposes, only right hand access configurations are shown, where applicable.

\* This dimension is based on using the standard 1000mm long stabiliser rail in the Front & Side Panel Component Packs.  
This dimension can be increased by a further 500mm by using the special 1500mm long stabiliser rail, 5WP1500SR, purchased separately through your retailer.

