

N 1/2 G CD

1901 Tap Range 1901 Basin Taps with Ceramic Disc Valves



Specification	
Style:	Traditional
Product Type:	Bathroom taps
Finish/Colour:	Vintage Gold
Main Construction Material:	Brass
Mount Type:	Deck
Handle Type:	Crosshead
Connection Inlet:	1/2" BSP
Number of Tap Holes Required:	2
Valve/Cartridge Type:	1/2" Ceramic Disc Valve
Plumbing System Suitability	All
Working Pressure Range:	Min 0.2 bar - Max 5 bar
Maximum Hot Water Temperature: °c	65
Maximum Dynamic Pressure: (bar)	5 bar
Maximum Static Pressure: (bar)	10
Flow Type:	Single Flow
Flow Rate: (l/min @ 3 bar)	61.6
Connection Outlet:	Open
Isolation Included:	No

Features:

- Metal heads
- Ceramic Discs

Product Certifications:



For more products, visit our website:

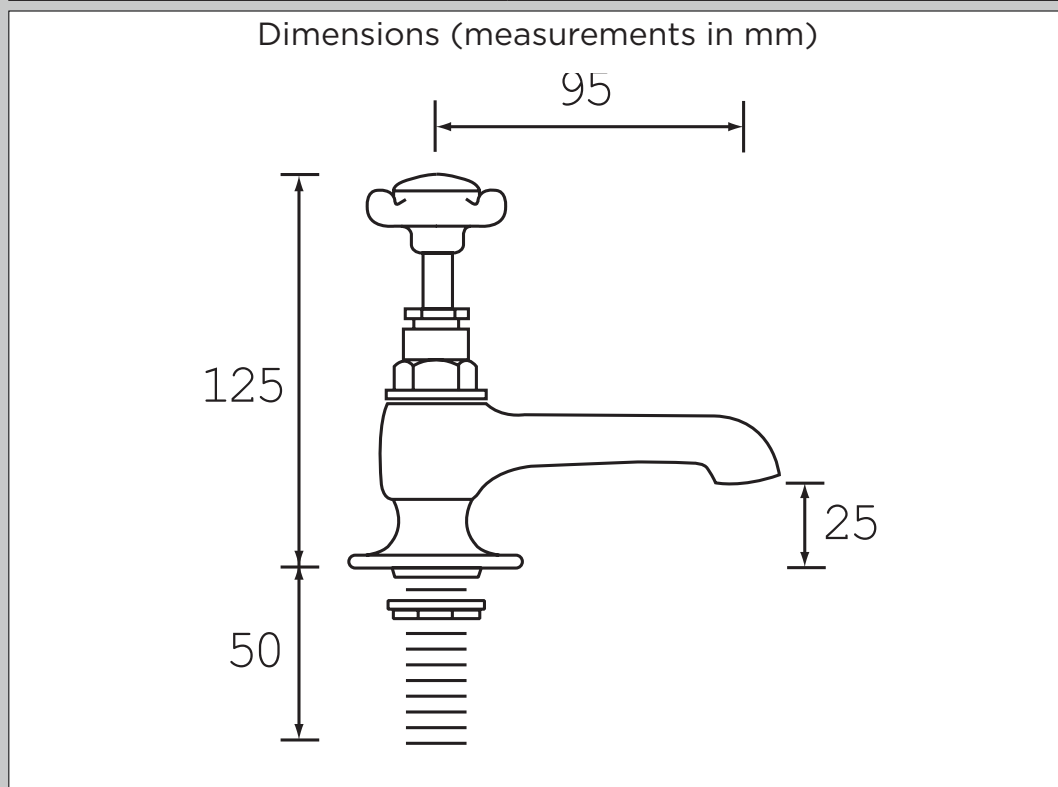

Flow Rates (l/min)						
System Pressure (bar)	0.2	0.5	1	2	3	5
N 1/2 G CD	15.9	25.2	35.6	50.3	61.6	79.6

TECHNICAL
DATA
SHEET



BRISTAN
TAPS & SHOWERS

D3