

OR 1/2 E6 C

ORTA Tap Range Orta Basin Taps Eco6 Chrome



Specification	
Style:	Contemporary
Product Type:	Bathroom taps
Finish/Colour:	Chrome
Main Construction Material:	Brass
Mount Type:	Deck
Handle Type:	Paddle
Connection Inlet:	1/2" BSP
Number of Tap Holes Required:	2
Valve/Cartridge Type:	1/2" Ceramic Disc Valve
Plumbing System Suitability	All
Working Pressure Range:	Min 0.2 bar - Max 5 bar
Maximum Hot Water Temperature: °c	65
Maximum Dynamic Pressure: (bar)	5 bar
Maximum Static Pressure: (bar)	10
Flow Type:	Single Flow
Flow Rate: (l/min @ 3 bar)	35.3
Connection Outlet:	M16 Aerator
Isolation Included:	No

Features:

- Supplied with metal handles
- Supplied with metal backnuts
- Product supplied with either 2 x 4 or 2 x 6 litre per minute flow regulators which can be inserted into the threaded tail to reduce water consumption and increase

Product Certifications:



For more products, visit our website:



Dimensions (measurements in mm)

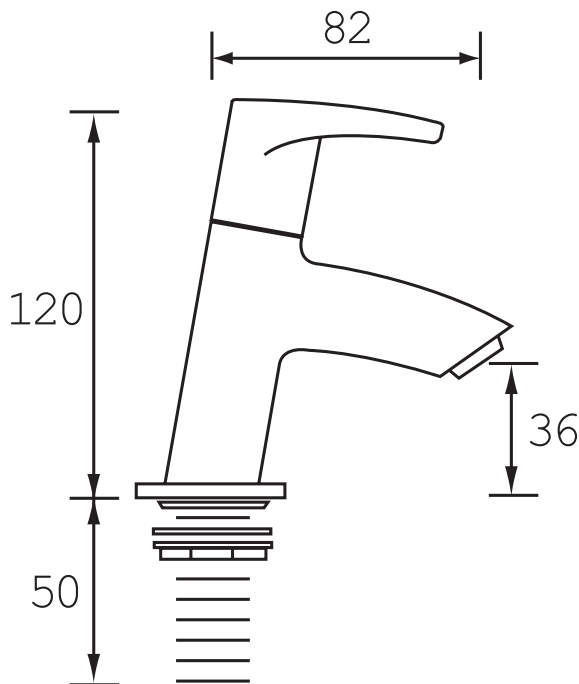

Flow Rates (l/min)

System Pressure (bar)	0.2	0.5	1	2	3	5
Without Flow Regulator	8.6	14.1	20.3	29.1	35.3	44.8
With 4 l/p/m Flow Regulator	--	--	6.0	6.0	6.0	6.0

TECHNICAL
DATA
SHEET



BRISTAN
TAPS & SHOWERS

D2