

## RAK KITCHEN TAPS

Athens | Modern Twin Lever | Kitchen Sink Mixer

**RAK**  
CERAMICS

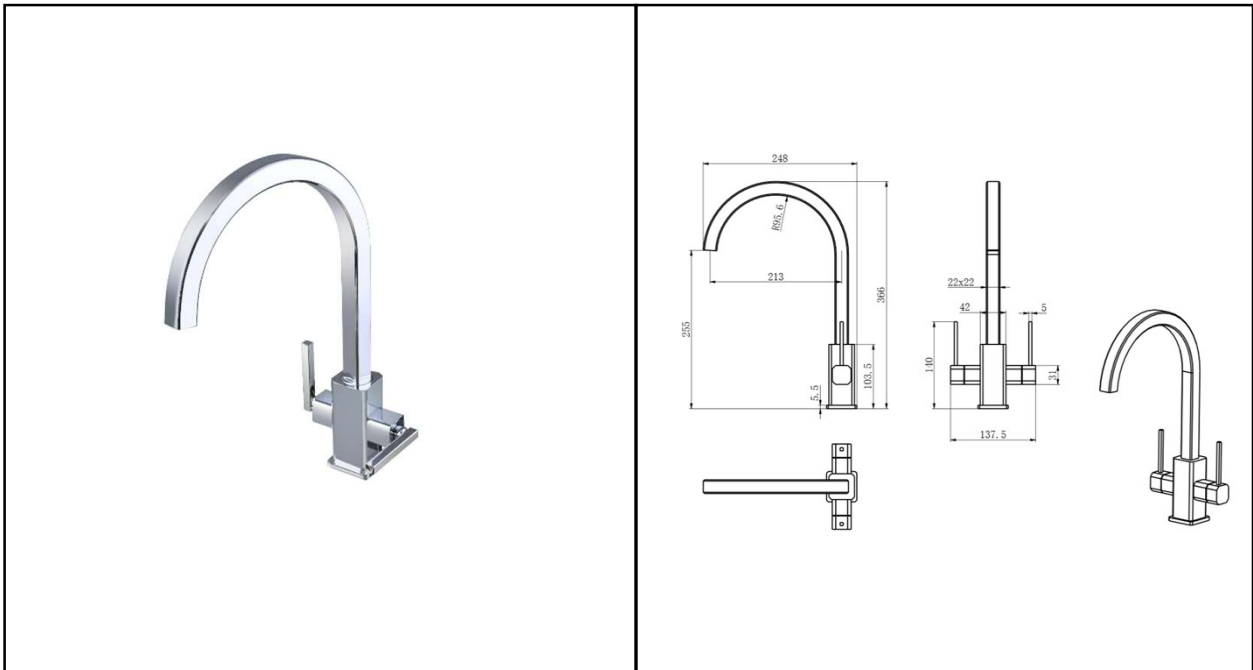

**Dimensions:** 137.5w x 213d x 255h mm

**Colour:** CHROME

**Code:** RAKKIT008

**Pressures:** 0.2 BAR - 6.0 BAR

**Warranty:** 15 YEARS

**Weight:** 2.50 KG

Dimensions: All Dimensions in mm tolerance  $\pm 5\%$  for below 200mm and  $\pm 3\%$  for above 200mm.  
Note: Due to a continuing development programme to improve design and performance the manufacturer reserves all rights to vary specifications without prior information.  
Please note accessories are for photographic use only.