

MERLYN IONIC



Your shower, your space™

THE IONIC COLLECTION



Contents

Introduction

02 The MERLYN Ionic Collection

Product

- 08 **Essence Frameless**
Frameless elegance
- 22 **Essence Framed**
Precision engineered
- 34 **Wetroom Panels**
Flexibility for your space
- 42 **Express**
The ultimate easy fit solution
- 56 **Source**
Affordable shower enclosures
- 63 **SecureSeal**
The ultimate leak-free bath screen
- 67 **Bath Screens**
Simple shapes
- 74 **TouchStone Trays**
Strong and durable
- 77 **MERLYN Upstand Tray**

Technical Section

78 Product Information

The MERLYN Ionic Collection Your Shower, Your Space

The MERLYN Ionic Collection features an extensive range of shower enclosures, trays and bath screens to suit every bathroom and every budget.

We spent many years researching our customers, installers and plumbers in the UK and Ireland. From this research we developed a range that is stylish, innovative, fast and easy to fit. The Ionic collection pairs precision engineering with the highest quality standards.

This range offers fantastic choice and functionality, you can be sure to find an enclosure to suit your bathroom space and budget. From the contemporary frameless Essence to the framed classic Express this collection has been developed to meet the highest quality standards while maintaining a very stylish look and feel. Create your beautiful bathroom today by selecting a MERLYN Ionic shower enclosure.



Essence Frameless | Page 08

The IONIC flagship range



Essence Framed | Page 22

A range offering multi function and choice



Wetroom Panels | Page 34

Mix and match combination of shapes and sizes



Express | Page 42 | **NEW** Low Level Sliding Door

The easiest fit system on the market



Source | Page 56

Excellence in design, durability and affordability



SecureSeal | Page 63

Leak free solution for baths



Bath Screens | Page 67

Contemporary screens that work with baths



TouchStone Trays | Page 74

Elegant low level installation trays



Upstand Trays | Page 77

Great value low level installation trays with upstand

Choose your Style

Products

| | Shape | Essence Frameless | Essence Framed |
|--------------------|-------------|-------------------|----------------|
| Sliding Door | Rectangular | ✓ | ✓ |
| Quadrant Door | Curved | ✓ | ✓ |
| Hinged Door | Rectangular | ✓ | — |
| Pivot Door | Square | — | ✓ |
| Bifold Door | Square | — | — |
| Showerwall/Walk In | Rectangular | — | — |
| Corner Entry | Square | — | — |
| Inline Panel | — | — | — |
| Bath Screen | — | — | — |
| Easy Fit System | — | — | — |
| Glass Thickness | — | 8mm | 8mm |
| Height | — | 2000mm | 1900mm |
| Guarantee | — | 20 Years | 20 Years |



CE & EN Information

The CE marking on Ionic enclosures is a declaration that the product complies with the essential requirements of the relevant European health, safety and environmental protection legislation to EN Standards – EN14428. Confirmation of CE approval and Declaration of Performance (DOP) is available on our website: www.merlynshowering.com.

For further information see Technical Section on page 78.

| Wetrooms Panels | Express | Source | SecureSeal | Bath Screens |
|-----------------|----------|---------|------------|--------------|
| — | ✓ | ✓ | — | — |
| — | ✓ | ✓ | — | — |
| — | — | — | — | — |
| — | ✓ | ✓ | — | — |
| — | ✓ | ✓ | — | — |
| ✓ | — | — | — | — |
| — | — | — | — | — |
| — | ✓ | — | — | — |
| — | — | — | ✓ | ✓ |
| — | ✓ | ✓ | — | — |
| 8mm | 6mm | 6mm | 6mm | 4, 6 & 8mm |
| 2000mm | 1900mm | 1850mm | 1500mm | 1400-1500mm |
| 20 Years | 20 Years | 5 Years | Lifetime | Lifetime |

ISO Certification

MERLYN has implemented an Integrated Management System comprising of Quality Management, Environmental Management and Occupational Health and Safety Management. An Integrated Management System ensures the seamless integration of several different standards into a common system that meets the requirements of each of these standards. These certifications are proof of **MERLYN**'s credibility but also to instil confidence in our potential clients that **MERLYN** will keep its promises.





Mershield Stayclear

MERLYN treats products in the Ionic Collection with a special protective coating to ensure the glass maintains its sparkle. This comes as standard on Essence, Express, Wetroom Panels and most of our Bath Screen range.

Mershield Stayclear acts as a protective coating which when applied to glass, helps the glass to remain shiny and new without the need for tiresome cleaning. When cleaned correctly it helps prevent the build up of limescale and soap deposits making the shower glass "easy to clean". Please see tips for keeping the glass in pristine condition.

Without Mershield Stayclear Protective Coating

Without Mershield Stayclear protection water and soap deposits cling to the glass surface causing a build up of grime, requiring more vigorous cleaning.

Natural glass surface



With Mershield Stayclear Protective Coating

The Mershield Stayclear coating provides a larger contact angle for the water droplet on the surface and makes the drops smaller than drops falling on an untreated surface. This ensures the droplets roll away much faster down the surface, minimising deposits left behind.

Mershield Stayclear coating

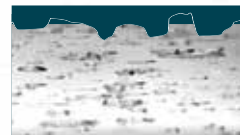

Mershield Stayclear coating creates a smooth layer over the surface of natural glass, lowering surface friction, making it easier for water, soap and lime deposits to run off the glass.

Tips on how to keep your glass in pristine condition

It is important to clean your glass after every use – wipe down with a soft cloth.

Install the enclosure in a well ventilated area.

Do not allow limescale to build up in hard water areas.

Ensure that any residual water on the glass is removed after every use.

Clean the glass regularly using soapy water.

DO NOT use abrasive products on any surfaces.

Check out our
all new website at
www.merlynshowering.com

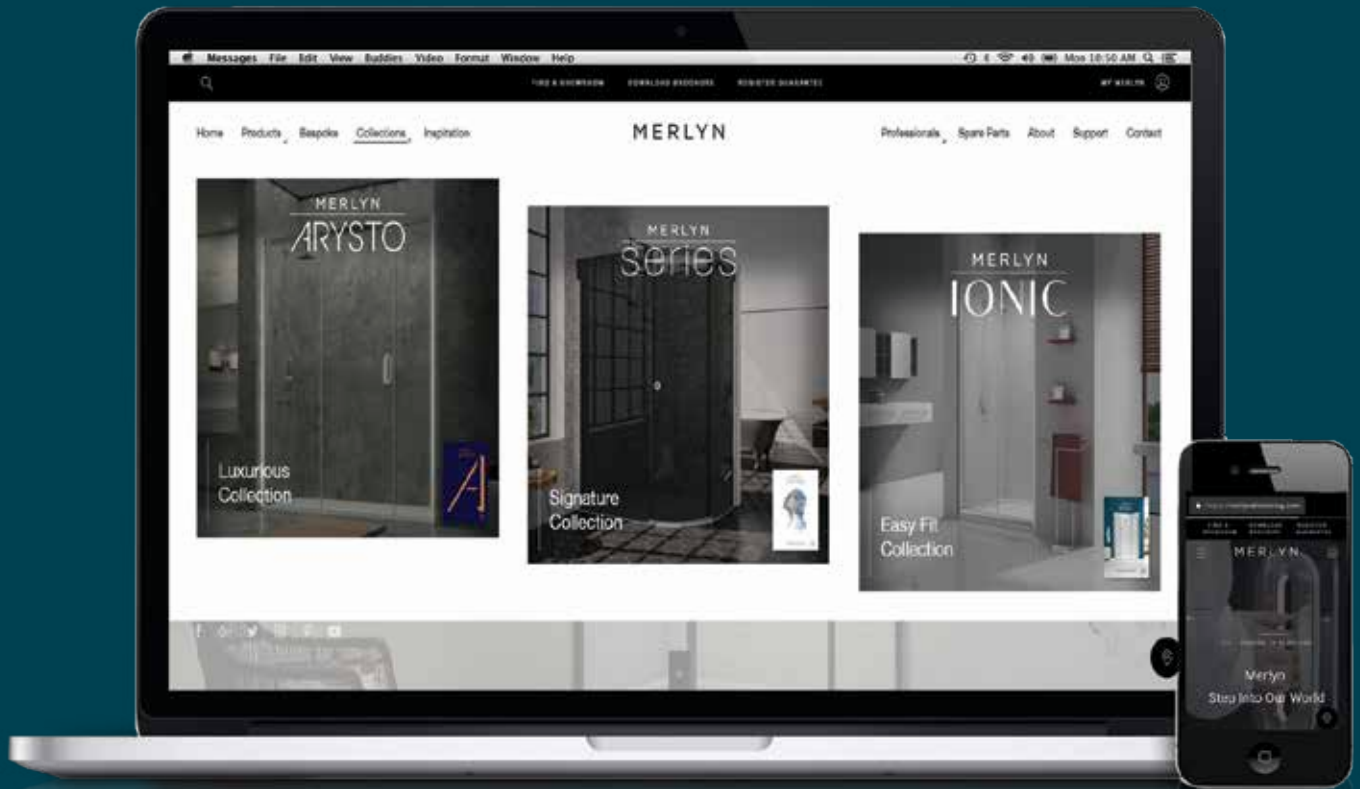

Keep up to date with our latest news

Find your nearest stockist.

Download our easy-to-use fitting instructions
and technical information.

Register your Guarantee

Download our brochures

Follow us online @merlynshowering to keep
up to date on our special offers and news!



Essence Frameless



Frameless Elegance

Ionic Essence is truly unique in its appearance with its fusion between stylish beauty and precision engineering. We have spent a great deal of time developing this range that not only exudes style; it also stays true to the basic Ionic principle: built to last.

Some additional features include concealed rollers to ensure it looks just as good on the inside as it does on the outside, discreet seals to help retain its frameless look, extra strong rollers that have gone through rigorous testing procedures along with many other little details that have been incorporated to ensure this product fits as seamlessly as possible for the installer.

Features

- Height 2000mm
- Stunning frameless design
- Reversible*
- Concealed fixings
- Exclusive Essence fixings kit provided
- Chrome double handle

Design Details



1 Branded glass clamp



4 Designer hinge with concealed pivot



2 Solid chrome double handle



3 Branded badge



5 Chrome double handle

*Quadrant Doors are handed.



11 Sliding Door in a Recess



13 Sliding Door with a Side Panel



15 Hinge & Inline Panel in a Recess

Frameless Elegance

The attention to detail is evident throughout this range with many additional clever features that ensure it is practical and functional while also maintaining its frameless elegance.



17 Hinge & Inline Panel with a Side Panel



19 1 Door Offset Quadrant



21 1 Door Quadrant



Features



2000mm



Concealed fixing



Reversible



Smooth action
extra strong rollers



Stunning frameless design



Discreet deflection seal
on luna rail for increased
water retention



Minimalist designer rail
with concealed rollers both
inside and outside



Chrome double handle

Essence Frameless

Sliding Door in a Recess



Product Details

Extension profiles available see page 81

Technical Details

A = Door Opening
B = Fixed Panel

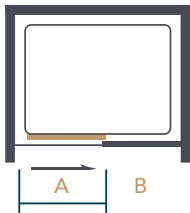

| Size | Adjustment (Min-Max) | Order Code | Price £ Exc. VAT | Price £ Inc. VAT |
|------|----------------------|------------|------------------|------------------|
| 1000 | 950-990 | A0104A0 | 783.33 | 939.99 |
| 1100 | 1050-1090 | A0104B0 | 783.33 | 939.99 |
| 1200 | 1150-1190 | A0104IH | 783.33 | 939.99 |
| 1400 | 1350-1390 | A0104DH | 830.86 | 997.03 |
| 1700 | 1650-1690 | A0104HH | 949.73 | 1139.67 |

| Size | A | B |
|------|-----|-----|
| 1000 | 365 | 465 |
| 1100 | 415 | 515 |
| 1200 | 465 | 565 |
| 1400 | 565 | 665 |
| 1700 | 565 | 965 |



Features



- 2000mm
- Concealed fixing
- Reversible
- Smooth action extra strong rollers
- Stunning frameless design
- Discreet deflection seal on luna rail for increased water retention
- Minimalist designer rail with concealed rollers both inside and outside
- Chrome double handle

Essence Frameless

Sliding Door with a Side Panel



Product Details

Extension profiles available see page 81

Technical Details

- A = Door Opening
- B = Fixed Panel
- C = Side Panel

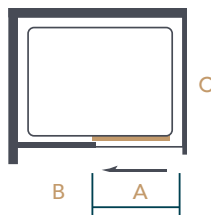

Please Note: The door needs to close against the side panel.

| Size | Adjustment (Min-Max) | Order Code | Price £ Exc. VAT | Price £ Inc. VAT |
|---------------------|----------------------|------------|---------------------|---------------------|
| 1000 | 940-965 | A0104A0 | 783.33 | 939.99 |
| 1100 | 1040-1065 | A0104B0 | 783.33 | 939.99 |
| 1200 | 1140-1165 | A0104IH | 783.33 | 939.99 |
| 1400 | 1340-1365 | A0104DH | 830.86 | 997.03 |
| 1700 | 1640-1665 | A0104HH | 949.73 | 1139.67 |
| Optional Side Panel | | | | |
| 800 | 760-785 | A0107I0 | 426.71 | 512.05 |
| 900 | 860-885 | A0107J0 | 450.53 | 540.63 |

| Size | A | B |
|------|-----|-----|
| 1000 | 350 | 465 |
| 1100 | 400 | 515 |
| 1200 | 450 | 565 |
| 1400 | 550 | 665 |
| 1700 | 550 | 965 |



Features



2000mm



Concealed fixing



Reversible



Solid chrome double handle symmetrical to hinges



Solid designer hinge with concealed pivot point



Stunning frameless design

Hinge & Inline Panel in a Recess



Product Details

Extension profiles available see page 81

Technical Details

- A = Door Opening
- B = Door Swing
- C = Inline Panel

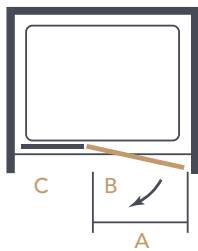

Please Note: Side Panel should only be used with + sizes (not standard sizes).

| Size | A | B | C |
|-------|-----|-----|-----|
| 760 | 440 | 460 | 160 |
| 800 | 440 | 460 | 200 |
| 800+ | 480 | 500 | 200 |
| 900 | 490 | 510 | 250 |
| 900+ | 530 | 550 | 250 |
| 1000 | 540 | 560 | 300 |
| 1000+ | 580 | 600 | 300 |
| 1100 | 590 | 610 | 350 |
| 1100+ | 630 | 650 | 350 |
| 1200 | 590 | 610 | 450 |
| 1200+ | 630 | 650 | 450 |
| 1400 | 590 | 610 | 650 |
| 1400+ | 630 | 650 | 650 |
| 1500 | 590 | 610 | 750 |
| 1500+ | 630 | 650 | 750 |

| Size | Adjustment (Min-Max) | Order Code | Price £ Exc. VAT | Price £ Inc. VAT |
|-------|----------------------|------------|------------------|------------------|
| 760 | 720-760 | A0111F0 | 675.17 | 810.20 |
| 800 | 760-800 | A0111C0 | 675.17 | 810.20 |
| 800+ | 800-840 | A0111M0 | 675.17 | 810.20 |
| 900 | 860-900 | A0111D0 | 675.17 | 810.20 |
| 900+ | 900-940 | A0111N0 | 675.17 | 810.20 |
| 1000 | 960-1000 | A0111E0 | 710.84 | 853.01 |
| 1000+ | 1000-1040 | A0111O0 | 710.84 | 853.01 |
| 1100 | 1060-1100 | A0111JH | 752.44 | 902.93 |
| 1100+ | 1100-1140 | A0111JF | 752.44 | 902.93 |
| 1200 | 1160-1200 | A0111GH | 752.44 | 902.93 |
| 1200+ | 1200-1240 | A0111GF | 752.44 | 902.93 |
| 1400 | 1360-1400 | A0111HH | 807.14 | 968.57 |
| 1400+ | 1400-1440 | A0111HF | 807.14 | 968.57 |
| 1500 | 1460-1500 | A0111KH | 866.53 | 1039.83 |
| 1500+ | 1500-1540 | A0111KF | 866.53 | 1039.83 |



Features

20yr.
Guarantee

MerShield
Stayclear

8mm

- 2000mm
- Concealed fixing
- Reversible
- Solid chrome double handle symmetrical to hinges
- Solid designer hinge with concealed pivot point
- Stunning frameless design

Hinge & Inline Panel with Side Panel

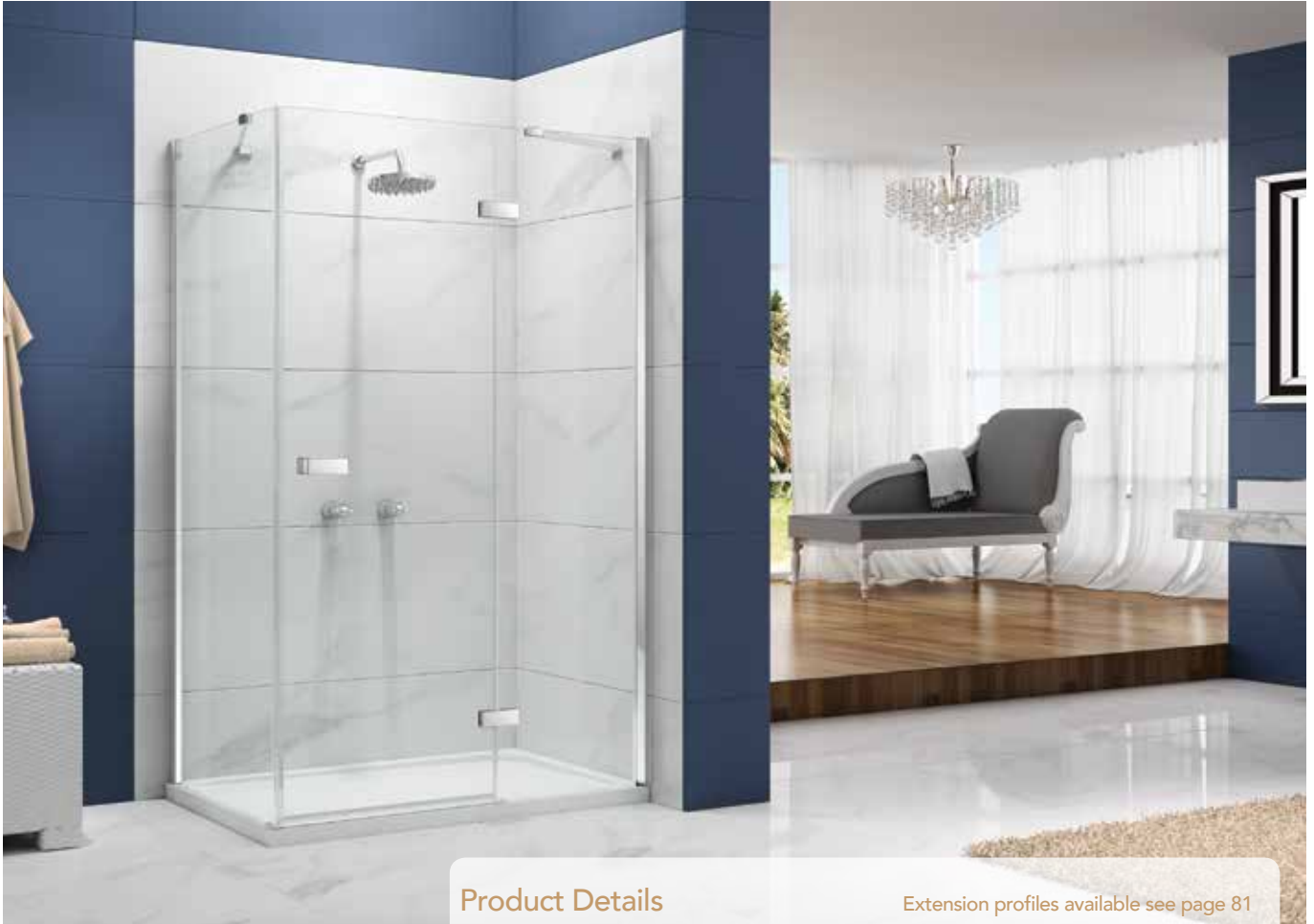

Product Details

Extension profiles available see page 81

Technical Details

- A = Door Opening
- B = Door Swing
- C = Inline Panel
- D = Side Panel

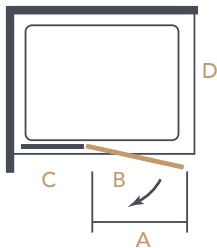

Please Note: Side Panel should only be used with + sizes (not standard sizes).

| Size | A | B | C |
|-------|-----|-----|-----|
| 800+ | 480 | 500 | 200 |
| 900+ | 530 | 550 | 250 |
| 1000+ | 580 | 600 | 300 |
| 1100+ | 630 | 650 | 350 |
| 1200+ | 630 | 650 | 450 |
| 1400+ | 630 | 650 | 650 |
| 1500+ | 630 | 650 | 750 |

| Size | Adjustment (Min-Max) | Order Code | Price £ Exc. VAT | Price £ Inc. VAT |
|-------|----------------------|------------|------------------|------------------|
| 800+ | 770-790 | A0111M0 | 675.17 | 810.20 |
| 900+ | 870-890 | A0111N0 | 675.17 | 810.20 |
| 1000+ | 970-990 | A0111O0 | 710.84 | 853.01 |
| 1100+ | 1070-1090 | A0111JF | 752.44 | 902.93 |
| 1200+ | 1170-1190 | A0111GF | 752.44 | 902.93 |
| 1400+ | 1370-1390 | A0111HF | 807.14 | 968.57 |
| 1500+ | 1470-1490 | A0111KF | 866.53 | 1039.83 |

| Optional Side Panel | | | | |
|---------------------|----------------------|------------|------------------|------------------|
| Size | Adjustment (Min-Max) | Order Code | Price £ Exc. VAT | Price £ Inc. VAT |
| 800 | 750-790 | A0107G0 | 391.04 | 469.25 |
| 900 | 850-890 | A0107H0 | 414.86 | 497.83 |



Features

1 Door Offset Quadrant shown as Left Hand



2000mm



Concealed fixing



Smooth action
extra strong rollers



Chrome double handle



Stunning frameless design



Minimalist designer rail
with concealed rollers
both inside and out



Discreet deflector seal on luna rail
for increased water retention



Extra strong rollers with additional
guide to added smoothness.

Essence Frameless

1 Door Offset Quadrant



1 Door Offset Quadrant

Product Details

Extension profiles available see page 81

Technical Details

- A = Door Opening
- B = Straight Panel
- C = Curved Panel

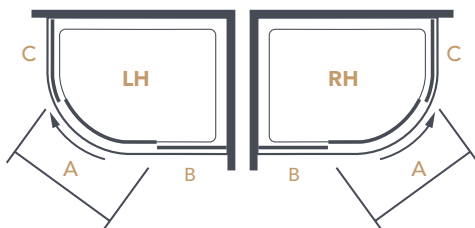

| Size | Adjustment (Min-Max) | Handed | Order Code | Price £ Exc. VAT | Price £ Inc. VAT |
|----------|------------------------|------------|------------|---------------------|---------------------|
| 1200x900 | 860-885 / 1160-1185 | Left Hand | A0101KH | 1187.47 | 1424.97 |
| 1200x900 | 860-885 / 1160-1185 | Right Hand | A0101LH | 1187.47 | 1424.97 |

| Size | A | B | C |
|----------|-----|-----|-----|
| 1200x900 | 475 | 590 | 550 |



Features

1 Door Quadrant shown as Left Hand



2000mm



Concealed fixing



Smooth action extra strong rollers



Chrome double handle



Stunning frameless design



Minimalist designer rail with concealed rollers both inside and out



Discreet deflector seal on luna rail for increased water retention



Extra strong rollers with additional guide to added smoothness

Essence Frameless

1 Door Quadrant



1 Door Quadrant

Product Details

Extension profiles available see page 81

Technical Details

- A = Door Opening
- B = Straight Panel
- C = Curved Panel

| Size | Adjustment (Min-Max) | Handed | Order Code | Price £ Exc. VAT | Price £ Inc. VAT |
|---------|----------------------|------------|------------|------------------|------------------|
| 900x900 | 860-885 | Left Hand | A0101MH | 1068.60 | 1282.32 |
| 900x900 | 860-885 | Right Hand | A0101NH | 1068.60 | 1282.32 |

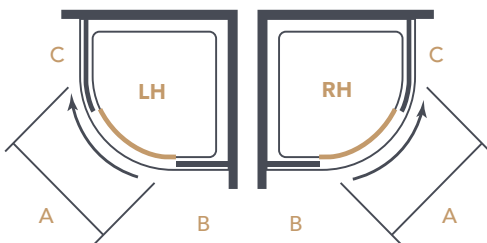

| Size | A | B | C |
|------|-----|-----|-----|
| 900 | 475 | 290 | 550 |

Essence Framed



Precision Engineered

Ionic Essence Framed is a stylish 8mm range, precision engineered to suit every bathroom space. Some of the main features of this range include the solid "Clunk" which highlights the quality of these enclosures. Colour matched chrome magnetic seals and concealed fittings to ensure it looks great all around and quick release double rollers which makes it hassle-free to clean.

Features

-  Height 1900mm
-  Concealed fixings
-  Solid 'Clunk' close
-  Reversible
-  Colour matched chrome magnetic seals

Design Details





24 Sliding Door with Side Panel



25 Sliding Door in a Recess



27 2 Door Quadrant

Precision Engineered

The framed beauty of this range delivers on functionality while maintaining the Ionic principle: built to last.



29 1 Door Quadrants



30 Pivot Door with Side Panel



33 Bifold Door in a Recess



Features

Sliding Door with Side Panel



1900mm



Concealed fixing



Reversible



Easy clean quick release rollers



Chrome finish including top cover caps



Chrome magnetic strips



Smooth action extra strong rollers

Essence Framed

Sliding Door



Sliding Door in a Recess

Product Details

Extension profiles available see page 81

Technical Details

A = Door Opening
B = Fixed Panel

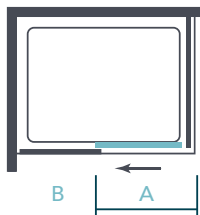

| Size | A | B |
|------|-----|-----|
| 1000 | 360 | 380 |
| 1100 | 410 | 430 |
| 1200 | 460 | 480 |
| 1400 | 560 | 580 |
| 1700 | 560 | 880 |

| Size | Adjustment (Min-Max) | Order Code | Price £ Exc. VAT | Price £ Inc. VAT |
|------|----------------------|------------|------------------|------------------|
| 1000 | 930-990 | DWH04A0 | 539.86 | 647.84 |
| 1100 | 1030-1090 | DWH04BI | 539.86 | 647.84 |
| 1200 | 1130-1190 | DWH04C0 | 539.86 | 647.84 |
| 1400 | 1330-1390 | DWH04DH | 623.79 | 748.55 |
| 1700 | 1630-1690 | DWH04EH | 720.20 | 864.24 |

| Optional Side Panel | | | | |
|---------------------|---------|---------|--------|--------|
| 760 | 720-750 | DWH07B0 | 251.47 | 301.77 |
| 800 | 760-790 | DWH07D0 | 251.47 | 301.77 |
| 900 | 860-890 | DWH07E0 | 296.50 | 355.80 |



Features



1900mm



Concealed fixing



Reversible



Easy clean quick release rollers



Chrome finish including top cover caps



Chrome magnetic strips

Essence Framed

2 Door Quadrant



Product Details

Extension profiles available see page 81

Technical Details

A = Door Opening
B = Fixed Panel

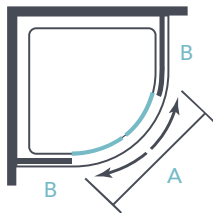

| Size | Adjustment (Min-Max) | Order Code | Price £ Exc. VAT | Price £ Inc. VAT |
|------|----------------------|------------|---------------------|---------------------|
| 800 | 750-780 | DWH02A0 | 675.06 | 810.08 |
| 900 | 850-880 | DWH02B0 | 675.06 | 810.08 |
| 1000 | 950-980 | DWH02CH | 765.23 | 918.28 |

| Size | A | B |
|------|-----|-----|
| 800 | 370 | 180 |
| 900 | 520 | 280 |
| 1000 | 520 | 380 |



Features

1 Door Offset Quadrant



1900mm



Easy clean quick release rollers



Reversible



Concealed fixing



Chrome finish including top cover caps

Essence Framed

1 Door Quadrants



1 Door Quadrant

Product Details

Extension profiles available see page 81

Technical Details

1 Door Quadrant

A = Door Opening
B = Straight Panel
C = Curved Panel

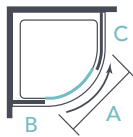

| Size | A | B | C |
|------|-----|-----|-----|
| 900 | 450 | 330 | 460 |

1 Door Offset Quadrant

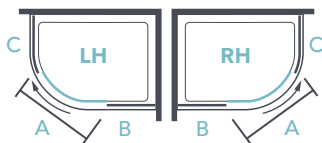

| Size | A | B | C |
|----------|-----|-----|-----|
| 1000x800 | 394 | 430 | 430 |
| 1200x800 | 394 | 630 | 430 |
| 1200x900 | 450 | 630 | 460 |

| Size | Adjustment (Min-Max) | Order Code | Price £ Exc. VAT | Price £ Inc. VAT |
|------|----------------------|------------|------------------|------------------|
|------|----------------------|------------|------------------|------------------|

| | | | | |
|------------------------|---------------------|---------|--------|--------|
| 1 Door Quadrant | | | | |
| 900 | 850-880 | DWH03DH | 747.24 | 896.69 |
| 1 Door Offset Quadrant | | | | |
| 1000x800 | 750-780 / 950-980 | DWH03BH | 774.28 | 929.14 |
| 1200x800 | 750-780 / 1150-1180 | DWH03CH | 774.28 | 929.14 |
| 1200x900 | 850-880 / 1150-1180 | DWH03EH | 774.28 | 929.14 |



Pivot Door shown with Side Panel

Features



1900mm



Concealed fixing



Reversible



Chrome finish including top cover caps



Coloured matching chrome magnetic seals



Solid "Clunk" close

Essence Framed

Pivot Door



Pivot Door in a Recess

Product Details

Extension profiles available see page 81

Technical Details

A = Door Opening

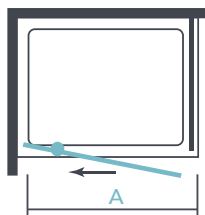

| Size | Adjustment (Min-Max) | Order Code | Price £ Exc. VAT | Price £ Inc. VAT |
|------|----------------------|------------|------------------|------------------|
|------|----------------------|------------|------------------|------------------|

| | | | | |
|-----|---------|---------|--------|--------|
| 760 | 690-750 | DWH06B0 | 449.80 | 539.76 |
| 800 | 730-790 | DWH06D0 | 476.84 | 572.21 |
| 900 | 830-890 | DWH06E0 | 494.83 | 593.80 |

Optional Side Panel

| | | | | |
|-----|---------|---------|--------|--------|
| 760 | 720-750 | DWH07B0 | 251.47 | 301.77 |
| 800 | 760-790 | DWH07D0 | 251.47 | 301.77 |
| 900 | 860-890 | DWH07E0 | 296.50 | 355.80 |

| Size | A |
|------|-----|
| 760 | 433 |
| 800 | 473 |
| 900 | 573 |



Features

Bifold Door with Side Panel



1900mm



Concealed fixing



Space saving solution



Chrome finish including top cover caps



Reversible

Essence Framed

Bifold Door



Bifold Door in Recess

Product Details

Extension profiles available see page 81

Technical Details

A = Door Opening

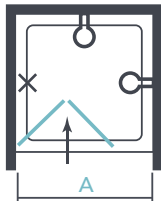

| Size | A |
|------|-----|
| 760 | 436 |
| 800 | 476 |
| 900 | 576 |
| 1000 | 626 |

| Size | Adjustment (Min-Max) | Order Code | Price £ Exc. VAT | Price £ Inc. VAT |
|---------------------|----------------------|------------|------------------|------------------|
| 760 | 690-750 | DWH00B0 | 517.92 | 621.50 |
| 800 | 730-790 | DWH00C0 | 517.92 | 621.50 |
| 900 | 830-890 | DWH00D0 | 547.04 | 656.45 |
| 1000 | 930-990 | DWH00E0 | 622.96 | 747.55 |
| Optional Side Panel | | | | |
| 760 | 720-750 | DWH07B0 | 251.47 | 301.77 |
| 800 | 760-790 | DWH07D0 | 251.47 | 301.77 |
| 900 | 860-890 | DWH07E0 | 296.50 | 355.80 |

Wetroom Panels



Flexibility for your Space

The Ionic range of Wetroom Panels offer you the choice to mix and match many combinations of shapes and sizes to any space you require. At MERLYN Ionic, we understand that every wetroom space is different, which is why we have designed a modular system of wetroom panels that can be combined to fit any area. We have broken the range down to 17 key components with additional fitting options which you can build together to make up the full wetroom of your choice. It's as simple as A, B, C.

Wetroom Panels

| Diagram Ref | Size | Adjustment Min-Max | Order Code | Price £ Exc. VAT | Price £ Inc. VAT |
|-------------|-----------------|--------------------|------------|------------------|------------------|
| A | 300** | 275-290 | A0409J0 | 248.56 | 298.27 |
| B | 400** | 375-390 | A0409K0 | 258.96 | 310.75 |
| C | 500** | 475-490 | A0409L0 | 269.36 | 323.23 |
| D | 600** | 575-590 | A0409M0 | 279.76 | 335.71 |
| E | 700* | 675-690 | A0409A0 | 304.30 | 365.16 |
| F | NEW 760* | 735-750 | A0409N0 | 304.30 | 365.16 |
| G | 800* | 775-790 | A0409B0 | 304.30 | 365.16 |
| H | 900* | 875-890 | A0409C0 | 304.30 | 365.16 |
| I | 1000 | 975-990 | A0409D0 | 330.41 | 396.49 |
| J | 1100 | 1075-1090 | A0409F0 | 355.37 | 426.44 |
| K | 1200 | 1175-1190 | A0409E0 | 355.37 | 426.44 |
| L | 1400 | 1375-1390 | A0409G0 | 414.86 | 497.83 |
| M | 1600 | 1575-1590 | A0409H0 | 466.96 | 560.35 |
| N | 200 | Swivel Panel | A0413H0 | 169.52 | 203.42 |
| O | 300 | Swivel Panel | A0413G0 | 177.11 | 212.53 |
| P | 400 | Swivel Panel | A0413J0 | 191.36 | 229.63 |
| Q | 300 | Cube Panel | A0413F0 | 156.29 | 187.55 |

*Please Note: Panels A-H are the only panels that can be used as an end panel.

**Please Note: Panels A-D do not come with a stabilising bar / Panels E-M come with stabilising bar.

Fitting Options

| | Size | Product | Order Code | Price £ Exc. VAT | Price £ Inc. VAT |
|------------|------|------------------------------|--------------|------------------|------------------|
| | 350 | Angled stabilising bar | SP08SCU12320 | 95.25 | 114.31 |
| NEW | 400 | Vertical ceiling bracing bar | CBB440 | 134.00 | 160.80 |
| | 1000 | 8mm round stabilising bar | A0417A0 | 98.21 | 117.85 |
| NEW | 1500 | 8mm extended stabilising bar | A0S0105 | 219.00 | 262.80 |
| | - | Round T Piece bracket | A04S0010 | 44.22 | 53.06 |
| | 2000 | Corner profile | A04S0003 | 45.43 | 54.51 |
| | 3000 | Vertical Post | A0417C0 | 153.34 | 184.01 |

Features

- Height 2015mm (including rail)
- Reversible
- Optional vertical post, swivel panel and cube panel available
- All panels above 700mm come with a 1000mm stabilising bar
- New corner profile option available
- Suitable for recess or corner situation
- Swivel panel can be retrofitted to any 8mm shower wall
- 3M support post can be retro-fitted to glass thicknesses of 6mm, 8mm and 10mm

How it Works

If you wanted to make up a Walk In Wetroom for an area to fit on to a 1200mm x 800mm tray or floor. You pick a panel E (700mm) and a G(800mm), this also includes the recommended 500mm minimum opening for the Walk In.

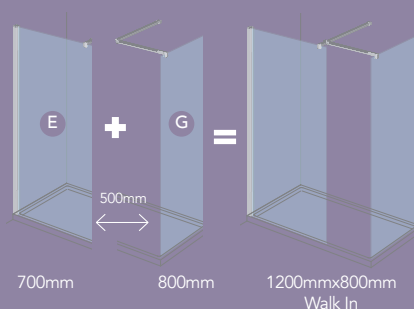

Minimum Opening

We recommend a minimum opening of 500mm for any wetroom area.

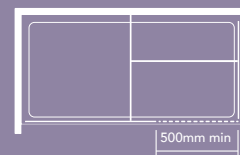



36 Showerwalls



37 Showerwall with Vertical Post



38 Walk In



39 Walk In with Swivel Panel

Flexibility for your Space

With innovative sizes and panels built with luxurious 8mm glass, this range is sure to impress.



40 Cube



41 Showerwall x 2 with Corner Profile

Showerwalls



Showerwall with Swivel Panel

Product Details

| Diagram Ref | Size | Adjustment Min-Max | Order Code | Price £ Exc. VAT | Price £ Inc. VAT |
|-------------|-----------------|--------------------|------------|------------------|------------------|
| A | 300** | 275-290 | A0409J0 | 248.56 | 298.27 |
| B | 400** | 375-390 | A0409K0 | 258.96 | 310.75 |
| C | 500** | 475-490 | A0409L0 | 269.36 | 323.23 |
| D | 600** | 575-590 | A0409M0 | 279.76 | 335.71 |
| E | 700* | 675-690 | A0409A0 | 304.30 | 365.16 |
| F | NEW 760* | 735-750 | A0409N0 | 304.30 | 365.16 |
| G | 800* | 775-790 | A0409B0 | 304.30 | 365.16 |
| H | 900* | 875-890 | A0409C0 | 304.30 | 365.16 |
| I | 1000 | 975-990 | A0409D0 | 330.41 | 396.49 |
| J | 1100 | 1075-1090 | A0409F0 | 355.37 | 426.44 |
| K | 1200 | 1175-1190 | A0409E0 | 355.37 | 426.44 |
| L | 1400 | 1375-1390 | A0409G0 | 414.86 | 497.83 |
| M | 1600 | 1575-1590 | A0409H0 | 466.96 | 560.35 |
| N | 200 | Swivel Panel | A0413H0 | 169.52 | 203.42 |
| O | 300 | Swivel Panel | A0413G0 | 177.11 | 212.53 |
| P | 400 | Swivel Panel | A0413J0 | 191.36 | 229.63 |
| Q | 300 | Cube Panel | A0413F0 | 156.29 | 187.55 |
| R | 3000 | Vertical Post | A0417C0 | 153.34 | 184.01 |
| S | NEW 400 | Ceiling bar | CBB440 | 134.00 | 160.80 |

Features



- 2015mm (including rail)
- Reversible
- 180 degree swivel on Swivel Panel
- Can be used on tray or wetroom floor
- Suitable for recess or corner situation
- Swivel panel can be retrofitted to any 8mm Shower Wall



*Please Note: Panels A-H are the only panels that can be used as an end panel.

**Please Note: Panels A-D do not come with a stabilising bar / Panels E-M come with stabilising bar.

Showerwalls with Vertical Post



Features



2015mm (including rail)



Reversible



Can be used on tray or wetroom floor



Suitable for recess or corner situation



3M support post can be retro-fitted to glass thicknesses of 6mm, 8mm and 10mm

Product Details

| Diagram Ref | Size | Adjustment Min-Max | Order Code | Price £ Exc. VAT | Price £ Inc. VAT |
|-------------|-----------------|--------------------|------------|------------------|------------------|
| A | 300** | 275-290 | A0409J0 | 248.56 | 298.27 |
| B | 400** | 375-390 | A0409K0 | 258.96 | 310.75 |
| C | 500** | 475-490 | A0409L0 | 269.36 | 323.23 |
| D | 600** | 575-590 | A0409M0 | 279.76 | 335.71 |
| E | 700* | 675-690 | A0409A0 | 304.30 | 365.16 |
| F | NEW 760* | 735-750 | A0409N0 | 304.30 | 365.16 |
| G | 800* | 775-790 | A0409B0 | 304.30 | 365.16 |
| H | 900* | 875-890 | A0409C0 | 304.30 | 365.16 |
| I | 1000 | 975-990 | A0409D0 | 330.41 | 396.49 |
| J | 1100 | 1075-1090 | A0409F0 | 355.37 | 426.44 |
| K | 1200 | 1175-1190 | A0409E0 | 355.37 | 426.44 |
| L | 1400 | 1375-1390 | A0409G0 | 414.86 | 497.83 |
| M | 1600 | 1575-1590 | A0409H0 | 466.96 | 560.35 |
| R | 3000 | Vertical Post | A0417C0 | 153.34 | 184.01 |

*Please Note: Panels A-H are the only panels that can be used as an end panel.

**Please Note: Panels A-D do not come with a stabilising bar / Panels E-M come with stabilising bar.

Walk In



Product Details

| Diagram Ref | Size | Adjustment Min-Max | Order Code | Price £ Exc. VAT | Price £ Inc. VAT |
|-------------|-----------------|--------------------|------------|------------------|------------------|
| A | 300** | 275-290 | A0409J0 | 248.56 | 298.27 |
| B | 400** | 375-390 | A0409K0 | 258.96 | 310.75 |
| C | 500** | 475-490 | A0409L0 | 269.36 | 323.23 |
| D | 600** | 575-590 | A0409M0 | 279.76 | 335.71 |
| E | 700* | 675-690 | A0409A0 | 304.30 | 365.16 |
| F | NEW 760* | 735-750 | A0409N0 | 304.30 | 365.16 |
| G | 800* | 775-790 | A0409B0 | 304.30 | 365.16 |
| H | 900* | 875-890 | A0409C0 | 304.30 | 365.16 |
| I | 1000 | 975-990 | A0409D0 | 330.41 | 396.49 |
| J | 1100 | 1075-1090 | A0409F0 | 355.37 | 426.44 |
| K | 1200 | 1175-1190 | A0409E0 | 355.37 | 426.44 |
| L | 1400 | 1375-1390 | A0409G0 | 414.86 | 497.83 |
| M | 1600 | 1575-1590 | A0409H0 | 466.96 | 560.35 |

Features



2015mm (including rail)



Reversible



Can be used on tray or wetroom floor



Suitable for Recess or Corner Situation

Technical Details

We recommend a minimum opening of 500mm for any wetroom panel combination.

*Please Note: Panels A-H are the only panels that can be used as an end panel.

**Please Note: Panels A-D do not come with a stabilising bar / Panels E-M come with stabilising bar.

Walk In with Swivel Panel



Features



- 2015mm (including rail)
- Reversible
- 180 degree swivel on Swivel Panel
- Can be used on tray or wetroom floor
- Suitable for Recess or Corner Situation
- Swivel panel can be retrofitted to any 8mm Shower Wall

Technical Details

We recommend a minimum opening of 500mm for any wetroom panel combination.

Product Details

| Diagram Ref | Size | Adjustment Min-Max | Order Code | Price £ Exc. VAT | Price £ Inc. VAT |
|-------------|-----------------|--------------------|------------|------------------|------------------|
| A | 300** | 275-290 | A0409J0 | 248.56 | 298.27 |
| B | 400** | 375-390 | A0409K0 | 258.96 | 310.75 |
| C | 500** | 475-490 | A0409L0 | 269.36 | 323.23 |
| D | 600** | 575-590 | A0409M0 | 279.76 | 335.71 |
| E | 700* | 675-690 | A0409A0 | 304.30 | 365.16 |
| F | NEW 760* | 735-750 | A0409N0 | 304.30 | 365.16 |
| G | 800* | 775-790 | A0409B0 | 304.30 | 365.16 |
| H | 900* | 875-890 | A0409C0 | 304.30 | 365.16 |
| I | 1000 | 975-990 | A0409D0 | 330.41 | 396.49 |
| J | 1100 | 1075-1090 | A0409F0 | 355.37 | 426.44 |
| K | 1200 | 1175-1190 | A0409E0 | 355.37 | 426.44 |
| L | 1400 | 1375-1390 | A0409G0 | 414.86 | 497.83 |
| M | 1600 | 1575-1590 | A0409H0 | 466.96 | 560.35 |
| N | 200 | Swivel Panel | A0413H0 | 169.52 | 203.42 |
| O | 300 | Swivel Panel | A0413G0 | 177.11 | 212.53 |
| P | 400 | Swivel Panel | A0413J0 | 191.36 | 229.63 |

*Please Note: Panels A-H are the only panels that can be used as an end panel.

**Please Note: Panels A-D do not come with a stabilising bar / Panels E-M come with stabilising bar.

Cube



Product Details

| Diagram Ref | Size | Adjustment Min-Max | Order Code | Price £ Exc. VAT | Price £ Inc. VAT |
|-------------|-----------------|--------------------|------------|------------------|------------------|
| A | 300** | 275-290 | A0409J0 | 248.56 | 298.27 |
| B | 400** | 375-390 | A0409K0 | 258.96 | 310.75 |
| C | 500** | 475-490 | A0409L0 | 269.36 | 323.23 |
| D | 600** | 575-590 | A0409M0 | 279.79 | 335.71 |
| E | 700* | 675-690 | A0409A0 | 304.30 | 365.16 |
| F | NEW 760* | 735-750 | A0409N0 | 304.30 | 365.16 |
| G | 800* | 775-790 | A0409B0 | 304.30 | 365.16 |
| H | 900* | 875-890 | A0409C0 | 304.30 | 365.16 |
| I | 1000 | 975-990 | A0409D0 | 330.41 | 396.49 |
| J | 1100 | 1075-1090 | A0409F0 | 355.37 | 426.44 |
| K | 1200 | 1175-1190 | A0409E0 | 355.37 | 426.44 |
| L | 1400 | 1375-1390 | A0409G0 | 414.86 | 497.83 |
| M | 1600 | 1575-1590 | A0409H0 | 466.96 | 560.35 |
| Q | 300 | Cube Panel | A0413F0 | 156.29 | 187.55 |

Features



2015mm (including rail)



Reversible



Can be used on a wetroom floor only



Suitable for recess or corner situation

Technical Details

We recommend a minimum opening of 500mm for any wetroom panel combination
Cube Panel width: 300mm.

*Please Note: Panels A-H are the only panels that can be used as an end panel.

**Please Note: Panels A-D do not come with a stabilising bar / Panels E-M come with stabilising bar.

Showerwall with Corner Panel



Features



- 2015mm (including rail)
- Reversible
- Can be used on a wetroom floor only
- Suitable for corner situation only
- We recommend using a stabilising bar for all size panels with this configuration

Product Details

| Diagram Ref | Size | Adjustment Min-Max | Order Code | Price £ Exc. VAT | Price £ Inc. VAT |
|-------------|-----------------|--------------------|------------|------------------|------------------|
| A | 300** | 275-290 | A0409J0 | 248.56 | 298.27 |
| B | 400** | 375-390 | A0409K0 | 258.96 | 310.75 |
| C | 500** | 475-490 | A0409L0 | 269.36 | 323.23 |
| D | 600** | 575-590 | A0409M0 | 279.76 | 335.71 |
| E | 700* | 675-690 | A0409A0 | 304.30 | 365.16 |
| F | NEW 760* | 735-750 | A0409N0 | 304.30 | 365.16 |
| G | 800* | 775-790 | A0409B0 | 304.30 | 365.16 |
| H | 900* | 875-890 | A0409C0 | 304.30 | 365.16 |
| I | 1000 | 975-990 | A0409D0 | 330.41 | 396.49 |
| J | 1100 | 1075-1090 | A0409F0 | 355.37 | 426.44 |
| K | 1200 | 1175-1190 | A0409E0 | 355.37 | 426.44 |
| L | 1400 | 1375-1390 | A0409G0 | 414.86 | 497.83 |
| M | 1600 | 1575-1590 | A0409H0 | 466.96 | 560.35 |
| Q | 2000 | Corner Profile | A04S0003 | 45.43 | 54.51 |

Please Note: Corner Profile must be used with two Showerwall Panels

***Please Note:** Panels A-H are the only panels that can be used as an end panel.

****Please Note:** Panels A-D do not come with a stabilising bar / Panels E-M come with stabilising bar.

Express

The Ultimate Easy-fit Solution

The ultimate easy-fit shower enclosure system. Express by name, express by nature. With innovation at its core, the Ionic Express range has been designed with you in mind, this range has a unique east-fit system which makes it the easiest fit on the market.

Many of the pieces in this range come pre-assembled to save you time and effort. Not only is this range easy-fit, it has been developed to the highest quality standards while maintaining a stylish contemporary look and feel.



Watch our online fastfit demo



Features

- ✓ Unique easy fit system
- ✓ Height 1900mm
- ✓ Reversible*
*Low Level Access Sliding Door is handed
- ✓ NEW Low Level Sliding Door is compatible with wetroom and tray situations
- ✓ Quick release easy clean double rollers
- ✓ Fixed panels come pre-assembled to wall profile
- ✓ All rollers come pre-assembled on moving panels
- ✓ Additional inline panels available to fit awkward spaces

03 Easy Fit Steps



Step 01
Slot and connect
frame in place.



Step 02
Slide mechanism
to secure profile at
each corner.

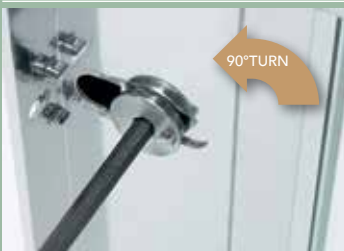

Step 03
Quarter turn to lock wall and
upright profiles in place,
without the need for drilling
through aluminium.



47 Sliding Door



49 Pivot Door

NEW
from MERLYN

Low Level Access Sliding Door

At MERLYN we are constantly striving to provide new solutions for our customers. With future-proofing being an essential part of bathroom planning, we are excited to launch our **NEW IONIC Express Low Level Sliding Door**. This new enclosure allows easy access for users on both wetroom and tray situations - no more stepping required.

With the same great benefits as our standard IONIC Express Sliding Door – easy cleaning and increased water retention – this door offers a new solution with the same great quality you can expect from MERLYN.



45 Low Level Access Sliding Door **NEW**



51 Bifold Door

Express by Name Express by Nature

With innovation at its core, the Ionic Express range has been designed with a unique easy-fit system which makes it the easiest fit on the market.



53 2 Door Quadrants



55 1 Door Quadrant



Sliding Door with Side Panel shown as Right hand



1900mm



Fast Fit System



Door Handed



No bottom rollers - NEW bottom glide system instead



Push-button door release for easy clean



Rollers pre-assembled on the top of the door



Allows easy access for users on both tray and wetroom situations - no more stepping required.



Adjustable fin seal for increased water retention, allowing the seal to always be flush with the floor/tray

03

Easy Fit Steps

The Easy Fit Range means less drilling and less screws. For installation instructions see page 42.

NEW
from MERLYN

Express

Sliding Door

Low Level Access



Slimline Threshold



Push Release



Sliding Door in a Recess shown as Left hand

Technical Details

A = Door Opening
B = Fixed Panel

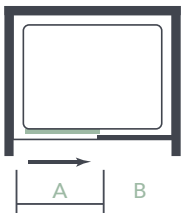

| Size | A | B |
|------|-----|-----|
| 1000 | 376 | 433 |
| 1200 | 476 | 533 |
| 1400 | 576 | 633 |
| 1700 | 576 | 933 |

Product Details

Extension profiles available see page 81

| Size | Recess Adjustment (Min-Max) | Side Panel Adjustment (Min-Max) | Handed | Order Code | Price £ Exc. VAT | Price £ Inc. VAT |
|------|-----------------------------|---------------------------------|--------|------------|------------------|------------------|
| 1000 | 950-990 | 960-1000 | Left | A0303A0 | 477.00 | 572.40 |
| 1000 | 950-990 | 960-1000 | Right | A0303B0 | 477.00 | 572.40 |
| 1200 | 1150-1190 | 1160-1200 | Left | A0303G0 | 477.00 | 572.40 |
| 1200 | 1150-1190 | 1160-1200 | Right | A0303H0 | 477.00 | 572.40 |
| 1400 | 1350-1390 | 1360-1400 | Left | A0303LH | 614.00 | 736.80 |
| 1400 | 1350-1390 | 1360-1400 | Right | A0303MH | 614.00 | 736.80 |
| 1700 | 1650-1690 | 1660-1700 | Left | A0303SH | 677.00 | 812.40 |
| 1700 | 1650-1690 | 1660-1700 | Right | A0303TH | 677.00 | 812.40 |

Optional Side Panel

| | | | | |
|-----|---------|---------|--------|--------|
| 700 | 650-670 | A0307A0 | 255.53 | 306.63 |
| 760 | 710-730 | A0307B0 | 255.53 | 306.63 |
| 800 | 750-770 | A0307D0 | 255.53 | 306.63 |
| 900 | 850-870 | A0307E0 | 281.74 | 338.08 |

Ionic Express Inline Panel (For more details see page 82)

| | | | | |
|-----|---------|---------|--------|--------|
| 150 | 130-150 | A0315B0 | 212.78 | 255.34 |
| 210 | 190-210 | A0315C0 | 212.78 | 255.34 |
| 490 | 470-490 | A0315D0 | 248.77 | 298.52 |



Sliding Door with Inline Panel in a Recess

Sliding Door with Side Panel

Features



1900mm



Easy-fit system



Reversible



Smooth action
extra strong rollers



Concealed fixing



Easy clean quick
release rollers



Double fin seal for
increased water retention



Rollers pre-assembled on door

03

Easy Fit Steps

The Easy Fit Range means less drilling and less screws. For installation instructions see page 42.

Express

Sliding Door



Sliding Door in a Recess

Product Details

Extension profiles available see page 81

Technical Details

A = Door Opening
B = Fixed Panel

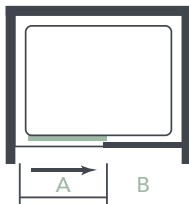

| Size | A | B |
|------|-----|-----|
| 1000 | 380 | 433 |
| 1100 | 430 | 483 |
| 1200 | 480 | 533 |
| 1400 | 580 | 633 |
| 1500 | 580 | 733 |
| 1600 | 580 | 833 |
| 1700 | 580 | 933 |

| Size | Adjustment (Min-Max) | Order Code | Price £ Exc. VAT | Price £ Inc. VAT |
|------|----------------------|------------|------------------|------------------|
| 1000 | 950-990 | A0304A0 | 414.86 | 497.83 |
| 1100 | 1050-1090 | A0304B0 | 414.86 | 497.83 |
| 1200 | 1150-1190 | A0304C0 | 414.86 | 497.83 |
| 1400 | 1350-1390 | A0304DH | 533.73 | 640.47 |
| 1500 | 1450-1490 | A0304GH | 568.15 | 681.78 |
| 1600 | 1550-1590 | A0304EH | 581.26 | 697.51 |
| 1700 | 1650-1690 | A0304HH | 588.43 | 706.12 |

Optional Side Panel (Please Note: Add 10mm to the a above adjustment when fitted with optional Side Panel)

| | | | | |
|-----|---------|---------|--------|--------|
| 700 | 650-670 | A0307A0 | 255.53 | 306.63 |
| 760 | 710-730 | A0307B0 | 255.53 | 306.63 |
| 800 | 750-770 | A0307D0 | 255.53 | 306.63 |
| 900 | 850-870 | A0307E0 | 281.74 | 338.08 |

Ionic Express Inline Panel (For more details see page 82)

| | | | | |
|-----------|---------|---------|--------|--------|
| 150 | 130-150 | A0315B0 | 212.78 | 255.34 |
| 210 | 190-210 | A0315C0 | 212.78 | 255.34 |
| 490 (New) | 470-490 | A0315D0 | 248.77 | 298.52 |

For Inline Panel size calculations please see page 82.

Please Note: Sliding Door can be paired with 2 additional Side Panels.



Pivot Door with Inline Panel & Side Panel

Pivot Door with Side Panel

Features



1900mm



Easy-fit system



Reversible



Concealed fixing



20mm adjustment per wall profile

01

Easy Fit Step

The Easy Fit Range means less drilling and less screws. For installation instructions see page 42.

Express

Pivot Door



Pivot Door in a Recess

Product Details

Extension profiles available see page 81

Technical Details

A = Door Opening
B = Door Swing

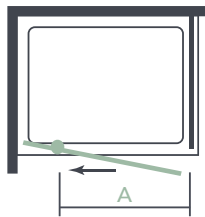

| Size | A | B |
|------|-----|-----|
| 700 | 415 | 390 |
| 760 | 475 | 450 |
| 800 | 515 | 490 |
| 900 | 615 | 590 |
| 1000 | 715 | 690 |

| Size | Adjustment (Min-Max) | Order Code | Price £ Exc. VAT | Price £ Inc. VAT |
|------|----------------------|------------|------------------|------------------|
| 700 | 650-690 | A0306A0 | 354.22 | 425.07 |
| 760 | 710-750 | A0306B0 | 354.22 | 425.07 |
| 800 | 750-790 | A0306D0 | 354.22 | 425.07 |
| 900 | 850-890 | A0306E0 | 407.68 | 489.22 |
| 1000 | 950-990 | A0306G0 | 449.28 | 539.14 |

Optional Side Panel (Please Note: Add 10mm to the above adjustment when fitted with optional Side Panel)

| | | | | |
|-----|---------|---------|--------|--------|
| 700 | 650-670 | A0307A0 | 255.53 | 306.63 |
| 760 | 710-730 | A0307B0 | 255.53 | 306.63 |
| 800 | 750-770 | A0307D0 | 255.53 | 306.63 |
| 900 | 850-870 | A0307E0 | 281.74 | 338.08 |

Ionic Express Inline Panel (For more details see page 82)

| | | | | |
|-----------|---------|---------|--------|--------|
| 150 | 130-150 | A0315B0 | 212.78 | 255.34 |
| 210 | 190-210 | A0315C0 | 212.78 | 255.34 |
| 490 (new) | 470-490 | A0315D0 | 248.77 | 298.52 |

For Inline Panel size calculations please see page 82.



Bifold Door with Inline Panel in a Recess

Bifold Door with Side Panel

Features



1900mm



Easy-fit system



Reversible



Concealed fixing



Discreet chrome bifold hinge



20mm adjustment per wall profile

01

Easy Fit Step

The Easy Fit Range means less drilling and less screws. For installation instructions see page 42.

Express

Bifold Door



Bifold Door in a Recess

Product Details

Extension profiles available see page 81

Technical Details

A = Door Opening

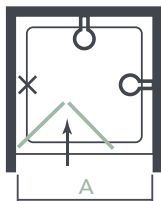

| Size | A |
|------|-----|
| 760 | 475 |
| 800 | 515 |
| 900 | 615 |
| 1000 | 715 |

| Size | Adjustment (Min-Max) | Order Code | Price £ Exc. VAT | Price £ Inc. VAT |
|------|----------------------|------------|------------------|------------------|
| 760 | 710-750 | A0300B0 | 397.07 | 476.49 |
| 800 | 750-790 | A0300C0 | 397.07 | 476.49 |
| 900 | 850-890 | A0300D0 | 424.32 | 509.18 |
| 1000 | 950-990 | A0300E0 | 493.27 | 591.93 |

Optional Side Panel (Please Note: Add 10mm to the above adjustment when fitted with optional Side Panel)

| | | | | |
|-----|---------|---------|--------|--------|
| 700 | 650-670 | A0307A0 | 255.53 | 306.63 |
| 760 | 710-730 | A0307B0 | 255.53 | 306.63 |
| 800 | 750-770 | A0307D0 | 255.53 | 306.63 |
| 900 | 850-870 | A0307E0 | 281.74 | 338.08 |

Ionic Express Inline Panel (For more details see page 82)

| | | | | |
|-----------|---------|---------|--------|--------|
| 150 | 130-150 | A0315B0 | 212.78 | 255.34 |
| 210 | 190-210 | A0315C0 | 212.78 | 255.34 |
| 490 (New) | 470-490 | A0315D0 | 248.77 | 298.52 |

For Inline Panel size calculations please see page 82.



Features

2 Door Offset Quadrant



1900mm



Easy-fit system



Reversible



Concealed fixing



Double fin seal for increased water retention



Easy clean quick release rollers



Smooth action extra strong rollers



Rollers pre-assembled on door

03

Easy Fit Steps

The Easy Fit Range means less drilling and less screws. For installation instructions see page 42.

Express

2 Door Quadrants



2 Door Quadrant

Product Details

Extension profiles available see page 81

Technical Details

A = Door Opening
B = Fixed Panel
C = Fixed Panel

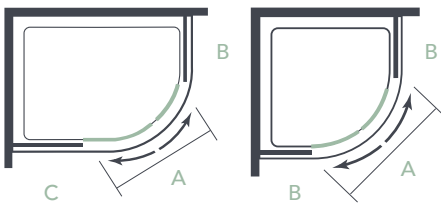

| Size | A | B | C |
|-------------------------------|-----|-----|-----|
| 2 Door Offset Quadrant | | | |
| 900x760 | 430 | 321 | 181 |
| 1000x800 | 465 | 421 | 221 |
| 1200x800 | 465 | 621 | 221 |
| 1200x900 | 540 | 621 | 321 |
| 2 Door Quadrant | | | |
| 800 | 390 | 221 | |
| 900 | 540 | 321 | |

| Size | Adjustment (Min-Max) | Order Code | Price £ Exc. VAT | Price £ Inc. VAT |
|------|----------------------|------------|------------------|------------------|
|------|----------------------|------------|------------------|------------------|

2 Door Offset Quadrant

| | | | | |
|----------|---------------------|---------|--------|--------|
| 900x760 | 855-875 / 715-735 | A0302C0 | 533.73 | 640.47 |
| 1000x800 | 955-975 / 755-775 | A0302D0 | 581.26 | 697.51 |
| 1200x800 | 1155-1175 / 755-775 | A0302HH | 674.02 | 808.83 |
| 1200x900 | 1155-1175 / 855-875 | A0302IH | 695.34 | 834.41 |

2 Door Quadrant

| | | | | |
|-----|---------|---------|--------|--------|
| 800 | 755-775 | A0302A0 | 474.24 | 569.09 |
| 900 | 855-875 | A0302B0 | 474.24 | 569.09 |

20mm Adjustment per wall profile.











Easy clean quick release rollers

1 Door Quadrant

Features



-  1900mm
-  Concealed fixing
-  Smooth action extra strong rollers
-  Easy-fit system
-  Double fin seal for increased water retention
-  Rollers pre-assembled on door
-  Reversible
-  Easy clean quick release rollers

03

Easy Fit Steps

The Easy Fit Range means less drilling and less screws. For installation instructions see page 42.

Express

1 Door Quadrant



Product Details

Extension profiles available see page 81

Technical Details

A = Door Opening
B = Fixed Panel
C = Fixed Panel

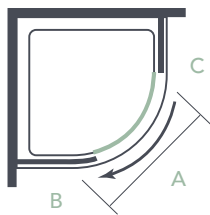

| Size | Adjustment (Min-Max) | Order Code | Price £ Exc. VAT | Price £ Inc. VAT |
|------|----------------------|------------|------------------|------------------|
| 900 | 855-875 | A0301B0 | 581.26 | 697.51 |

| Size | A | B | C |
|------|-----|-----|-----|
| 900 | 460 | 526 | 321 |

Source

Affordable Shower Enclosures

Ionic Source is our exciting range of affordable 6mm shower enclosures created by MERLYN. This range has been developed to offer our customers an exceptional quality shower enclosure without the hefty price tag.

Ionic Source has a fresh, contemporary look and feel. With simple clean lines, these showers will remain timeless for years to come. Standing at 1850mm high with 6mm* toughened glass with easy fit frame, robust quick release easy clean rollers, secure clunk closing and discreet modern fittings, the attention to detail and emphasis on quality is clearly evident throughout this range.

03 Easy Fit Steps



Step 01
Align the horizontal and vertical profiles together.



Step 02
Slot the horizontal profile and screws into upright using guide channel until flush.

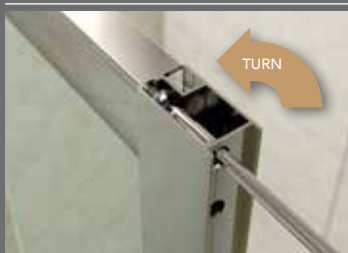

Step 03
Secure screws into position using dedicated access holes.

*Bifold door has 4mm glass



58 Sliding Door



59 2 Door Quadrants



60 Pivot Door

Quality Without the Hefty Price-tag

With our new 3 step pre-assembled frames the Ionic Source range is now easier and quicker to install than ever before.



61 Bifold Door



62 Corner Door

Source

Sliding Door

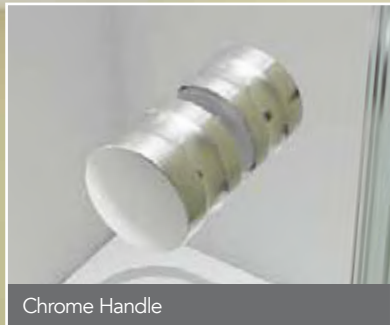

Chrome Handle



Sliding Door in a Recess

Product Details

Extension profiles available see page 81

| Size | Adjustment (Min-Max) | Order Code | Price £ Exc. VAT | Price £ Inc. VAT |
|------|----------------------|------------|------------------|------------------|
| 1000 | 950-990 | A1204A0 | 246.69 | 296.03 |
| 1100 | 1050-1090 | A1204B0 | 246.69 | 296.03 |
| 1200 | 1150-1190 | A1204C0 | 256.57 | 307.88 |

20mm Adjustment per wall profile.

| Optional Side Panels | | | | |
|----------------------|----------------------|------------|------------------|------------------|
| Size | Adjustment (Min-Max) | Order Code | Price £ Exc. VAT | Price £ Inc. VAT |
| 760 | 730-750 | A1207B0 | 147.58 | 177.09 |
| 800 | 770-790 | A1207D0 | 147.58 | 177.09 |
| 900 | 870-890 | A1207E0 | 157.46 | 188.95 |

Technical Details

| Size | A | B |
|------|-----|-----|
| 1000 | 380 | 400 |
| 1100 | 430 | 450 |
| 1200 | 480 | 500 |

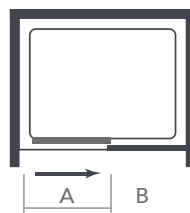

A = Door Opening
B = Fixed Panel

Features



1850mm



Chrome quick release
easy clean bottom rollers



Reversible



Easy fit frame



Screw cover caps



Magnetic seals

Source

2 Door Quadrants



Features



1850mm



Chrome quick release
easy clean bottom rollers



Reversible



Easy fit frame



Fixing cover caps



Magnetic seals

Product Details

Extension profiles available see page 81

| Size | Adjustment (Min-Max) | Order Code | Price £ Exc. VAT | Price £ Inc. VAT |
|----------|----------------------|------------|------------------|------------------|
| 800 | 770-790 | A1202A0 | 246.69 | 296.03 |
| 900 | 870-890 | A1202B0 | 246.69 | 296.03 |
| 1000x800 | 970-990 / 770-790 | A1202D0 | 335.82 | 402.98 |
| 1200x800 | 1170-1190 / 770-790 | A1202HH | 345.70 | 414.84 |
| 1200x900 | 1170-1190 / 870-890 | A1202IH | 355.58 | 426.69 |

20mm Adjustment per wall profile.

Technical Details

| Size | A | B | C |
|----------|-----|-----|-----|
| 800 | 400 | 210 | 210 |
| 900 | 540 | 310 | 310 |
| 1000x800 | 470 | 410 | 210 |
| 1200x800 | 470 | 610 | 210 |
| 1200x900 | 540 | 610 | 310 |

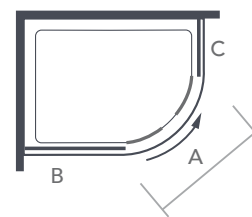

A = Door Opening
B = Fixed Panel
C = Fixed Panel

Source

Pivot Door



Product Details

Extension profiles available see page 81

| Size | Adjustment (Min-Max) | Order Code | Price £ Exc. VAT | Price £ Inc. VAT |
|------|----------------------|------------|------------------|------------------|
| 760 | 710-750 | A1206B0 | 197.08 | 236.50 |
| 800 | 750-790 | A1206D0 | 216.94 | 260.33 |
| 900 | 850-890 | A1206E0 | 236.70 | 284.04 |

20mm adjustment per wall profile.

Optional Side Panels

| | | | | |
|-----|---------|---------|--------|--------|
| 760 | 730-750 | A1207B0 | 147.58 | 177.09 |
| 800 | 770-790 | A1207D0 | 147.58 | 177.09 |
| 900 | 870-890 | A1207E0 | 157.46 | 188.95 |

Technical Details

| Size | A | B |
|------|-----|-----|
| 760 | 490 | 460 |
| 800 | 530 | 500 |
| 900 | 630 | 600 |

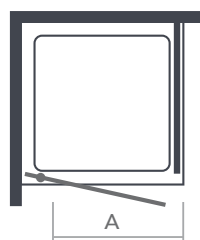

A = Door Opening

Features



1850mm



Reversible



Minimalist pivot



Pre-assembled frame



Screw cover caps



Magnetic seals

Source

Bifold Door



Features



1850mm



Reversible



Pre-assembled frame



Smooth running action



Screw cover caps



Magnetic seals

Product Details

Extension profiles available see page 81

| Size | Adjustment (Min-Max) | Order Code | Price £ Exc. VAT | Price £ Inc. VAT |
|------|----------------------|------------|---------------------|---------------------|
| 700 | 650-690 | A1200A0 | 236.70 | 284.04 |
| 760 | 710-750 | A1200B0 | 236.70 | 284.04 |
| 800 | 750-790 | A1200C0 | 246.69 | 296.03 |
| 900 | 850-890 | A1200D0 | 256.57 | 307.88 |

20mm Adjustment per wall profile.

Optional Side Panels

| | | | | |
|-----|---------|---------|--------|--------|
| 760 | 730-750 | A1207B0 | 147.58 | 177.09 |
| 800 | 770-790 | A1207D0 | 147.58 | 177.09 |
| 900 | 870-890 | A1207E0 | 157.46 | 188.95 |

Technical Details

| Size | A |
|------|-----|
| 700 | 400 |
| 760 | 460 |
| 800 | 500 |
| 900 | 600 |

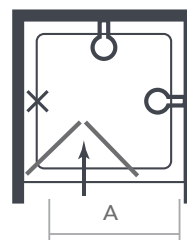

A = Door Opening

Source

Corner Door



Adjustable corner bracket

Product Details

Extension profiles available see page 81

| Size | Adjustment (Min-Max) | Order Code | Price £ Exc. VAT | Price £ Inc. VAT |
|---------|----------------------|------------|------------------|------------------|
| 760/800 | 740-790 | A1212V0 | 335.82 | 402.98 |
| 900 | 870 -890 | A1212B0 | 345.70 | 414.84 |

20mm adjustment per wall profile.

Technical Details

| Size | A |
|---------|---------|
| 760/800 | 350-390 |
| 900 | 460 |

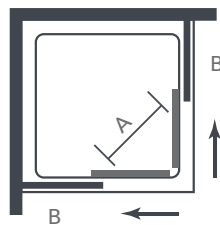

A = Door opening
B = Fixed panel

Features



- 1850mm
- Reversible
- Chrome quick release
easy clean bottom rollers
- Easy fit frame
- Screw cover caps
- Magnetic seals

How SecureSeal works

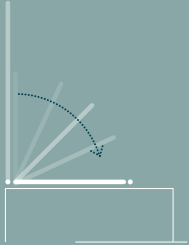

01.
Pull down arm
from storage
position.

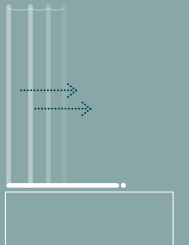

02.
Extend screen and
locate panels.

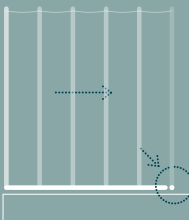

03.
Fully extend and
clip into position
for a secure fit
and tight seal.

SecureSeal.

by MERLYN

The Ultimate Leak-free Bath Screen

The SecureSeal by MERLYN has been designed with a leak free sealing arm which extends from the profile to create a complete seal between the bath and screen. When not in use the arm simply folds away back into the profile.

SecureSeal by MERLYN offers functional and easy to use designs to complement any bathroom space. With glass screen heights of 1500mm and 6mm glass, our SecureSeal by MERLYN range allows you to enjoy peace of mind in a leak free shower experience for years to come.

This range has been designed with the same superb materials and unrelenting attention to detail demonstrated across all MERLYN ranges.



SecureSeal.

4 Fold



Product Details

| Size | Adjustment (Min-Max) | Panels | Order Code | Price £ Exc. VAT | Price £ Inc. VAT |
|----------|----------------------|--------|------------|------------------|------------------|
| 800x1500 | 780-800mm | 4 | MS4 | 384.01 | 460.81 |

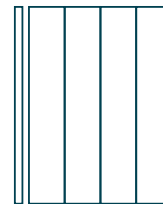

A = Moving panels (screen width when folded into the bath 228mm).

Recommended shower head position

4 Fold with Fixed Panel



Product Details

| Size | Adjustment (Min-Max) | Panels | Order Code | Price £ Exc. VAT | Price £ Inc. VAT |
|---------------------------------|----------------------|--------|------------|------------------|------------------|
| 800x1500 | 780-800mm | 4 | MS4 | 384.01 | 460.81 |
| Optional SecureSeal Fixed Panel | | | | | |
| 300x1500 | 300-320mm | 1 | MSFP | 181.94 | 218.33 |

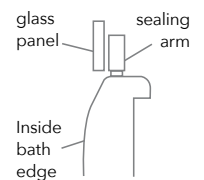
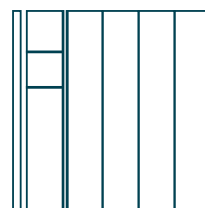
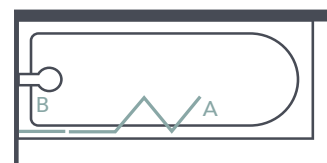

A = Moving panels (screen width when folded into the bath 228mm).

B = Fixed panel.

Recommended shower head position

SecureSeal.

5 Fold

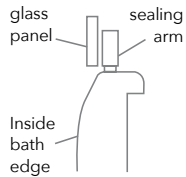
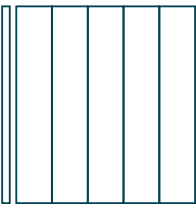
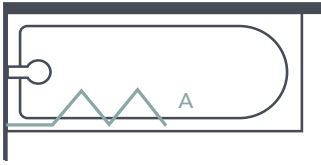

A = Moving panels (screen width when folded into the bath 228mm).

Recommended shower head position



Product Details

| Size | Adjustment (Min-Max) | Panels | Order Code | Price £ Exc. VAT | Price £ Inc. VAT |
|-----------|----------------------|--------|------------|------------------|------------------|
| 1000x1500 | 980-1000mm | 5 | MS5 | 432.19 | 518.63 |

5 Fold with Fixed Panel

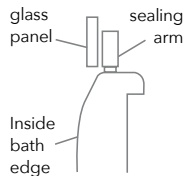

A = Moving panels (screen width when folded into the bath 228mm).

B = Fixed panel.

Recommended shower head position



Product Details

| Size | Adjustment (Min-Max) | Panels | Order Code | Price £ Exc. VAT | Price £ Inc. VAT |
|---------------------------------|----------------------|--------|------------|------------------|------------------|
| 1000x1500 | 980-1000mm | 5 | MS5 | 432.19 | 518.63 |
| Optional SecureSeal Fixed Panel | | | | | |
| 300x1500 | 300-320mm | 1 | MSFP | 181.94 | 218.33 |

Single Panel

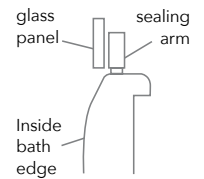
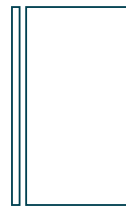
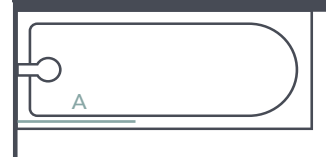
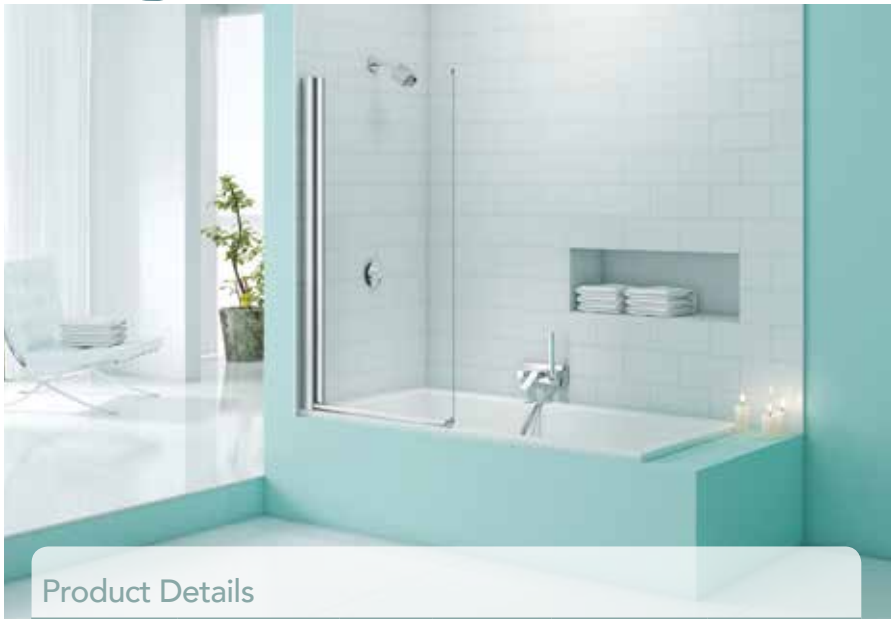

A = Moving panels (screen width when folded into the bath 712mm).

Recommended shower head position

Product Details

| Size | Adjustment (Min-Max) | Panels | Order Code | Price £ Exc. VAT | Price £ Inc. VAT |
|----------|----------------------|--------|------------|------------------|------------------|
| 800x1500 | 780-800mm | 1 | MS1 | 230.01 | 276.01 |

Single Panel with Fixed Panel

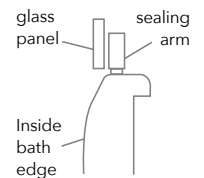
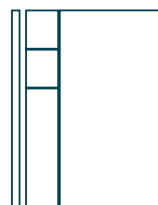
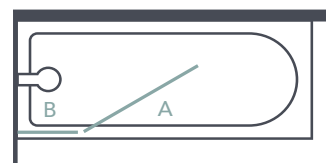

A = Moving panels (screen width when folded into the bath 712mm).

B = Fixed panel.

Recommended shower head position

Product Details

| Size | Adjustment (Min-Max) | Panels | Order Code | Price £ Exc. VAT | Price £ Inc. VAT |
|---------------------------------|----------------------|--------|------------|------------------|------------------|
| 800x1500 | 780-800mm | 1 | MS1 | 230.01 | 276.01 |
| Optional SecureSeal Fixed Panel | | | | | |
| 300x1500 | 300-320mm | 1 | MSFP | 181.94 | 218.33 |

Bath Screens

Simple Shapes

Ionic Bath Screens are the perfect solution for in-bath showering. Innovative design and contemporary aesthetics bring this bathroom favourite to life with modern shapes and features to enjoy for years to come.



HydraSEAL

HydraSEAL creates a barrier to restrict leaking!



We have created an exciting new feature, exclusive to MERLYN Bath Screens called HydraSEAL

HydraSEAL acts as an extra barrier, sealing the gap between the seal and the pivot point where water can usually escape.

It contains a high density foam that compresses onto the bath screen to form a tight seal and restricts water escaping from this problem area.

HydraSEAL is now available on our MB1, MB2, MB3, MB3A and MB3B bath screens.



Fixed Square



Single Curved



Product Details

| Size | Panels | Order Code | Price £ Exc. VAT | Price £ Inc. VAT |
|----------|--------|------------|------------------|------------------|
| 800x1500 | 1 | MBO | 112.94 | 135.53 |



Product Details

| Size | Panels | Order Code | Price £ Exc. VAT | Price £ Inc. VAT |
|----------|--------|------------|------------------|------------------|
| 800x1500 | 1 | MB1 | 154.13 | 184.95 |

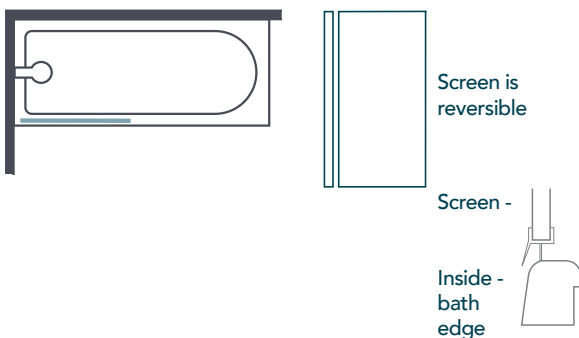

☞ Recommended shower head position

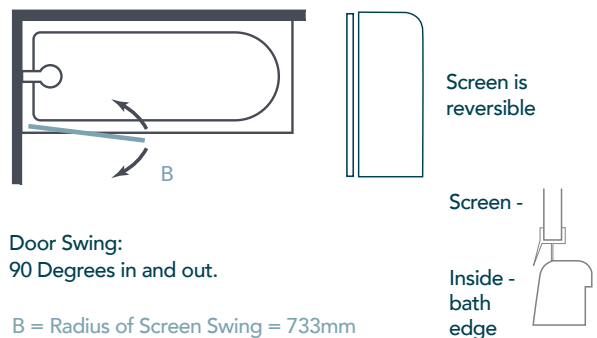

☞ Recommended shower head position



Single Square



Two Panel Curved



Product Details

| Size | Panels | Order Code | Price £ Exc. VAT | Price £ Inc. VAT |
|----------|--------|------------|------------------|------------------|
| 800x1500 | 1 | MB2 | 182.34 | 218.81 |

Product Details

| Size | Panels | Order Code | Price £ Exc. VAT | Price £ Inc. VAT |
|-----------|--------|------------|------------------|------------------|
| 1150x1500 | 2 | MB3 | 430.87 | 517.05 |

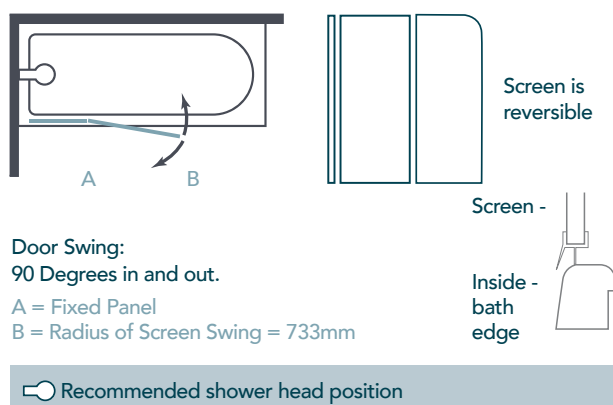
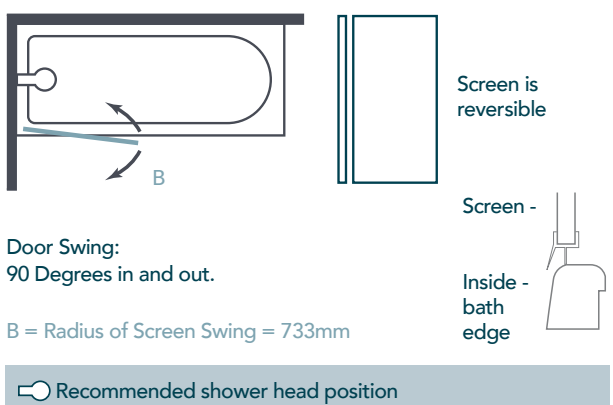



Two Panel Folding Curved



Two Panel Folding Square



Product Details

| Size | Panels | Order Code | Price £ Exc. VAT | Price £ Inc. VAT |
|----------|--------|------------|------------------|------------------|
| 900x1500 | 2 | MB3A | 254.70 | 305.64 |

Product Details

| Size | Panels | Order Code | Price £ Exc. VAT | Price £ Inc. VAT |
|----------|--------|------------|------------------|------------------|
| 900x1500 | 2 | MB3B | 254.70 | 305.64 |



Door Swing:
90 Degrees in and out.
A = Fixed Panel
B = Radius of Screen Swing = 483mm

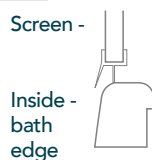

Recommended shower head position



Door Swing:
90 Degrees in and out.
A = Fixed Panel
B = Radius of Screen Swing = 483mm

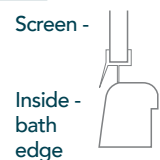

Recommended shower head position



Four Fold



Curtain Rail



Product Details

| Size | Panels | Order Code | Price £ Exc. VAT | Price £ Inc. VAT |
|----------|--------|------------|------------------|------------------|
| 850x1400 | 4 | MB4 | 302.57 | 363.08 |

Product Details

| Size | Panels | Order Code | Price £ Exc. VAT | Price £ Inc. VAT |
|----------|--------|------------|------------------|------------------|
| 300x1500 | 1 | MB5 | 202.73 | 243.27 |

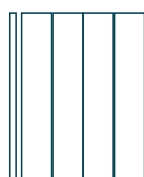

Screen is reversible

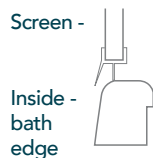

A = Moving Panels (panel width 200mm)

☉ Recommended shower head position

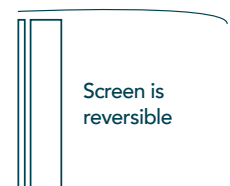
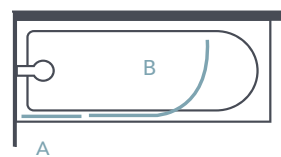

Screen is reversible

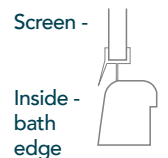

Height is 1550mm including rail.

A = Fixed Panel
B = Curtain Rail

☉ Recommended shower head position



Hinged Square



Product Details

| Size | Panels | Order Code | Price £ Exc. VAT | Price £ Inc. VAT |
|----------|--------|------------|------------------|------------------|
| 850x1500 | 1 | MB6 | 405.29 | 486.35 |

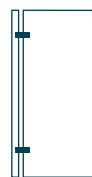
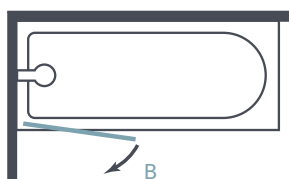

Screen is reversible

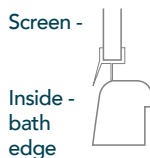

Door Swing:
90 Degrees outward swing only.

B = Radius of Screen Swing = 810mm

Recommended shower head position



Two Panel Hinged



Product Details

| Size | Panels | Order Code | Price £ Exc. VAT | Price £ Inc. VAT |
|----------|--------|------------|------------------|------------------|
| 900x1500 | 2 | MB7L (L) | 494.00 | 592.80 |
| 900x1500 | 2 | MB7R (R) | 494.00 | 592.80 |

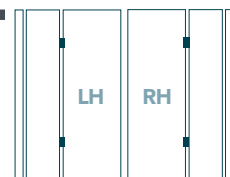
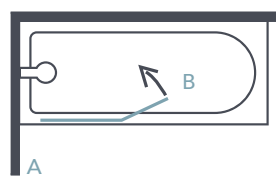

Screen is handed

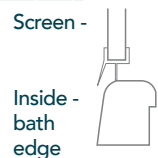

Door Swing:
180 Degrees inward only.

A = Fixed Panel
B = Radius of Screen Swing = 383mm

Recommended shower head position



Two Panel Folding



Three Panel Folding



Product Details

| Size | Panels | Order Code | Price £ Exc. VAT | Price £ Inc. VAT |
|-----------|--------|------------|------------------|------------------|
| 1100x1500 | 2 | MB8 | 491.32 | 589.58 |



Product Details

| Size | Panels | Order Code | Price £ Exc. VAT | Price £ Inc. VAT |
|-----------|--------|------------|------------------|------------------|
| 1400x1500 | 3 | MB9 | 614.43 | 737.32 |

Folding Panels

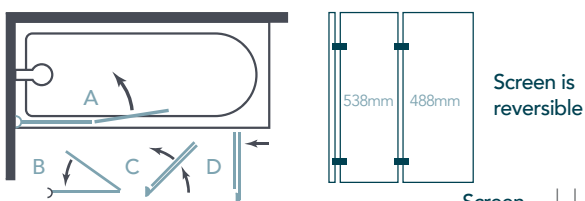

Door Swing:
180 Degrees Radius of screen swing inwards and outwards.

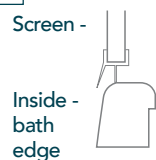

☐ Recommended shower head position

Folding Panels

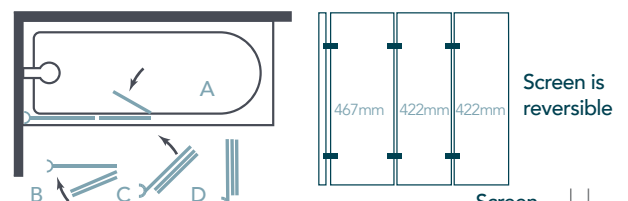

Door Swing:
180 Degrees Radius of Screen Swing inwards and outwards.

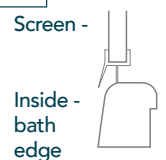

☐ Recommended shower head position

Touchstone Tray



Strong and Durable

Beautifully sculpted shower trays, angled and contoured to match enclosures and spaces, achieving the perfect combination of luxury, elegance and durability.

Features

- ✓ Single skinned with moulded solid under section
- ✓ 50mm high to achieve minimalist design
- ✓ 135mm high including tray panel kit
- ✓ Compatible 90mm fast flow waste also available
- ✓ More than 30 sizes available
- ✓ Available as low level or with tray panel kits for easy installation
- ✓ The TOUCHSTONE tray is capped with an easy to clean surface that provides a chemical resistant, anti-bacterial solution due to it's ultra-smooth, non-porous surface.

Design Details



Graduated adjustable leg and easy fit tray panel kit (Optional Extra).



90mm fast flow waste, includes hair trap and chrome cover (Optional Extra).



Graduated adjustable leg system.

Rectangular Tray



*Waste is centred on 1700x800 & 1700x900 trays.

Square Tray



TOUCHSTONE

Rectangle Tray

| Tray Size | Order Code | Tray Panel Kit | Price £ Exc. VAT | Price £ Inc. VAT |
|-----------|------------|----------------|------------------|------------------|
| 800x700 | S870RTTO | Kit 4 | 122.73 | 147.28 |
| 800x760 | S876RTTO | Kit 4 | 122.73 | 147.28 |
| 900x700 | S970RTTO | Kit 4 | 134.10 | 160.92 |
| 900x760 | S976RTTO | Kit 4 | 134.10 | 160.92 |
| 900x800 | S980RTTO | Kit 4 | 134.10 | 160.92 |
| 1000x700 | S107RTTO | Kit 4 | 138.48 | 166.17 |
| 1000x760 | S1076RTTO | Kit 4 | 138.48 | 166.17 |
| 1000x800 | S108RTTO | Kit 4 | 138.48 | 166.17 |
| 1000x900 | S109RTTO | Kit 4 | 143.80 | 172.56 |
| 1100x800 | S118RTTO | Kit 4 | 143.80 | 172.56 |
| 1200x700 | S127RTTO | Kit 4 | 143.80 | 172.56 |
| 1200x760 | S1276RTTO | Kit 4 | 150.65 | 180.79 |
| 1200x800 | S128RTTO | Kit 4 | 159.69 | 191.63 |
| 1200x900 | S129RTTO | Kit 4 | 171.39 | 205.67 |
| 1300x800 | S138RTTO | Kit 3 | 222.45 | 266.93 |
| 1400x700 | S147RTTO | Kit 3 | 229.11 | 274.93 |
| 1400x760 | S1476RTTO | Kit 3 | 229.11 | 274.93 |
| 1400x800 | S148RTTO | Kit 3 | 229.11 | 274.93 |
| 1400x900 | S149RTTO | Kit 3 | 241.48 | 289.77 |
| 1500x700 | S157RTTO | Kit 3 | 254.58 | 305.50 |
| 1500x760 | S1576RTTO | Kit 3 | 268.81 | 322.57 |
| 1500x800 | S158RTTO | Kit 3 | 268.81 | 322.57 |
| 1500x900 | S159RTTO | Kit 3 | 282.95 | 339.54 |
| 1600x700 | S167RTTO | Kit 3 | 299.94 | 359.92 |
| 1600x800 | S168RTTO | Kit 3 | 299.94 | 359.92 |
| 1600x900 | S169RTTO | Kit 3 | 314.93 | 377.92 |
| 1685x700 | S177RTTO | Kit 3 | 324.93 | 389.91 |
| 1680x760 | S1776RTTO | Kit 3 | 334.93 | 401.92 |
| 1700x800* | S178RTTO | Kit 3 | 364.43 | 437.31 |
| 1700x900* | S179RTTO | Kit 3 | 392.54 | 471.05 |

TOUCHSTONE

Square Tray

| Tray Size | Order Code | Tray Panel Kit | Price £ Exc. VAT | Price £ Inc. VAT |
|-----------|------------|----------------|------------------|------------------|
| 760x760 | S76SQTO | Kit 4 | 81.56 | 97.87 |
| 800x800 | S80SQTO | Kit 4 | 91.37 | 109.65 |
| 900x900 | S90SQTO | Kit 4 | 105.54 | 126.65 |

Square Tray Panel Kit – (Including Legs)

| Tray Size | Order Code | Tray Panel Kit | Price £ Exc. VAT | Price £ Inc. VAT |
|-----------|------------|----------------|------------------|------------------|
| 1200x900 | DRK4 | Kit 4 | 88.50 | 106.20 |

Rectangle Tray Panel Kits – (Including Legs)

| Tray Size | Order Code | Tray Panel Kit | Price £ Exc. VAT | Price £ Inc. VAT |
|-----------|------------|----------------|------------------|------------------|
| 1700x900 | DRK3 | Kit 3 | 88.50 | 106.20 |
| 1200x900 | DRK4 | Kit 4 | 88.50 | 106.20 |

Waste Complete Only

| Order Code | Price £ Exc. VAT | Price £ Inc. VAT |
|------------|------------------|------------------|
| DWAS | 20.80 | 24.96 |

THE TOUCHSTONE TRAY IS CAPPED WITH AN EASY TO CLEAN SURFACE THAT PROVIDES A CHEMICAL RESISTANT, ANTI-BACTERIAL SOLUTION DUE TO IT'S ULTRA-SMOOTH, NON-POROUS SURFACE.

90mm fast flow waste, includes hair trap and chrome cover.



Please Note: Price and order code does not include waste, waste must be ordered separately.

Quadrant Tray



TOUCHSTONE

Quadrant Tray

| Tray Size | Order Code | Tray Panel Kit | Price £ Exc. VAT | Price £ Inc. VAT |
|-----------|------------|----------------|------------------|------------------|
| 800 | S80QTO | Kit 2 | 99.98 | 119.97 |
| 900 | S90QTO | Kit 2 | 111.75 | 134.10 |

Quadrant Tray Panel Kits (Including Legs)

| Tray Size | Order Code | Tray Panel Kit | Price £ Exc. VAT | Price £ Inc. VAT |
|-----------|------------|----------------|------------------|------------------|
| 900 | DRK2 | Kit 2 | 88.50 | 106.20 |

Waste Complete Only

| Order Code | Price £ Exc. VAT | Price £ Inc. VAT |
|------------|------------------|------------------|
| DWAS | 20.80 | 24.96 |

90mm fast flow waste, includes hair trap and chrome cover.



Please Note: Price and order code does not include waste, waste must be ordered separately.

Offset Quadrant Tray



TOUCHSTONE

Shown as Left Hand (L)
Right Hand (R) also available

Offset Quadrant Tray

| Tray Size | Order Code | Tray Panel Kit | Price £ Exc. VAT | Price £ Inc. VAT |
|-------------------|------------|----------------|------------------|------------------|
| Right Hand | | | | |
| 1000x800 | S108QRTO | Kit 1 | 151.70 | 182.05 |
| 1200x800 | S128QRTO | Kit 1 | 159.69 | 191.63 |
| 1200x900 | S129QRTO | Kit 1 | 188.43 | 226.11 |
| Left Hand | | | | |
| 1000x800 | S108QLTO | Kit 1 | 151.70 | 182.05 |
| 1200x800 | S128QLTO | Kit 1 | 159.69 | 191.63 |
| 1200x900 | S129QLTO | Kit 1 | 188.43 | 226.11 |

This product is handed.
Please choose (L) for Left or (R) for Right when ordering.

Offset Quadrant Tray Panel Kit (Including Legs)

| Tray Size | Order Code | Tray Panel Kit | Price £ Exc. VAT | Price £ Inc. VAT |
|-----------|------------|----------------|------------------|------------------|
| 1200x900 | DRK1 | Kit 1 | 88.50 | 106.20 |

MERLYN UPSTAND



Features

- ✓ Single skinned with 4 upstands
- ✓ Available with 90mm branded fast flow waste (optional extra)
- ✓ Available with tray panel kits (optional extra)
- ✓ 135mm high with tray panel set (148mm high including upstand)
- ✓ 50mm high (63mm with upstand)

Rectangular Tray Square Tray

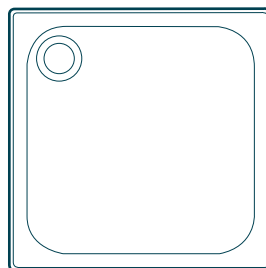

Rectangle Tray

| Tray Size | Order Code | Tray Panel Kit | Price £ Exc. VAT | Price £ Inc. VAT |
|-----------|------------|----------------|------------------|------------------|
| 900x760 | S976RTUP | Kit 4 | 170.77 | 204.92 |
| 1000x800 | S108RTUP | Kit 4 | 180.02 | 216.03 |
| 1200x760 | S1276RTUP | Kit 4 | 195.83 | 235.00 |
| 1200x800 | S128RTUP | Kit 4 | 207.58 | 249.10 |
| 1200x900 | S129RTUP | Kit 4 | 222.77 | 267.32 |

Tray Panel Kit - Including Legs

| Tray Size | Order Code | Tray Panel Kit | Price £ Exc. VAT | Price £ Inc. VAT |
|-----------|------------|----------------|------------------|------------------|
| 1200x900 | DRK4 | Kit 4 | 88.50 | 106.20 |

Square Tray

| Tray Size | Order Code | Tray Panel Kit | Price £ Exc. VAT | Price £ Inc. VAT |
|-----------|------------|----------------|------------------|------------------|
| 760 | S76SQUP | Kit 4 | 106.08 | 127.30 |
| 800 | S80SQUP | Kit 4 | 118.77 | 142.52 |
| 900 | S90SQUP | Kit 4 | 170.77 | 204.92 |

Waste Complete Only

| Order Code | Price £ Exc. VAT | Price £ Inc. VAT |
|------------|------------------|------------------|
| DWAS | 20.80 | 24.96 |

Please Note: Price and order code does not include waste, waste must be ordered separately.

90mm fast flow waste, includes hair trap and chrome cover.



Technical Section

We have produced this product section to help you with your purchasing decision. For further information please contact your local stockist, details of which can be found at www.merlynshowering.com

PRODUCT INFORMATION

All products are manufactured in accordance with EN 14428 and utilise toughened safety glass to EN 12150.

All doors feature adjustable wall profiles to compensate for out-of-true walls and have micro adjustment features for fine tuning to obtain a perfect fit and operating action.

Aluminium sections are extruded to BS 1474 from alloys complying with BS 6463 and coated to BS 6464.

All enclosures, wetrooms and panels are Power Shower approved – will retain water under normal showering conditions.

Water retention is maintained in all products under normal showering conditions.

A selection of Ionic enclosures are frameless in design. Spray/mist may escape therefore we would recommend use of these enclosures with tiled floors.

Opened cartons can not be returned. Returns carry a £40 box charge or £60 per unit where the sale is less than 30 days old. Returns over 30 days old will not be accepted.

All products are supplied complete with full installation instructions and the necessary fixings.

Check with your dealer for accurate matching of material samples.

Product descriptions do not imply the use of precious or valuable materials.

Our policy of reviewing product design and development on a regular basis means MERLYN reserve the right to change product specifications and prices without notice.

Only shower enclosures, panels and bath screens and some trays are covered by guarantees. Please contact the Ionic sales team for more details.

Glass shattering and parts subject to wear are not covered by your guarantee.

For full details on all product ranges please contact MERLYN Showering.

Trays shown in this catalogue are for illustrative purposes only.

Images are for illustrated purposes only. The colours and finishes shown in the catalogue are as accurate as possible within the limits of the printing process. The positioning of all showering heads in the brochure is for illustrative purposes only.

All descriptions, specifications and particulars contained in this brochure are intended merely to represent a general idea of the products described herein and none of these form part of any contract to give rise to any independent or collateral liability upon the company.

BATH SCREEN INFORMATION

Ionic Bath Screens are not designed to fit on baths with stepped fronts, roll top rims or integral soap dishes.

Fitting of screen on baths which have raised head rests or shapes is not recommended.

There must be no items causing obstruction with the seal and bath, as any of the above may cause leaks.

When choosing your Bath Screen, please ensure that if your bath has bath handles, that they do not interfere with the bath rim area where your screen will be placed.

When choosing an in-swing or folding Bath Screen, please ensure your swing area is not interfering with any brassware or internal shower features. Similarly, when choosing an out-swing, please ensure the out-swing area is free from any obstructions.

The Ionic MB72 Panel Hinged Bath Screen is handed so please ensure you state whether you require a right or left handed configuration when ordering.

Ionic Bath Screens are suitable for standard pressure showers and are not recommended for use with power showers.

It is recommended that the shower head position is situated on the same wall to which the Bath Screen is fixed and in the centre of the shower area.

CLEANING

It is important to clean your Ionic shower door after every use.

Wipe down all the glass and metal parts with a soft cloth.

Do not allow lime scale to build up in hard water areas.

Ensure that any residual water on the glass is removed after every use.

Clean the glass regularly using soapy water.

Do not use abrasive products on any surfaces.

Install the enclosure in a well ventilated area.

For more information on Mersfield Stayclear glass please see page 06 of this brochure.

INFORMATION AND MAINTENANCE

Always read the instructions on the packaging, chrome is vulnerable to acid attack and some strong household cleaners including strong disinfectants, denture cleaners, hair dyes, wine making chemicals and photographic chemicals may contain acid. These materials may have a varying effect on the surface from black spots/streaks (which cannot be removed) to pitting the surface. Contact with these materials should be avoided.

IMPORTANT SHOWER TRAY INFORMATION

Although shower door and enclosure sizes are related to tray sizes it is important to note that most shower trays are tiled down to the rim, often over an "up-stand". The finished installation space may be less than the nominal tray size.

Ionic shower units are made to suit this remaining space.

The guide below may be helpful in taking measurements to determine the shower door or enclosure size required. Dimensions given in this publication are in millimetres, are approximate and may vary with adjustment. They are subject to change without notice.

Please note that when a tray is fitted it is essential that the tray is level before any doors or enclosures are fitted.

Tray upstands: ensure strong and secure joints between shower tray and walls, even in the event of floor settlement. Tiling must be finished over the recessed upstand as shown in the diagram below.

Cleaning: clean after every use with warm soapy water and wipe dry with soft cloth, never use a gritty or abrasive cleaner.

Take the measurements after the tray is installed and the walls are tiled.

Recess Location

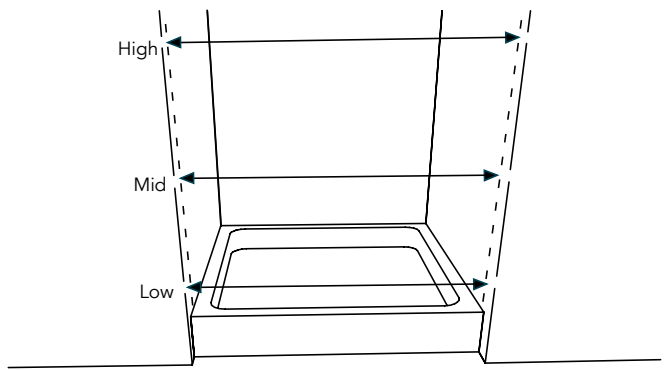

Corner Location

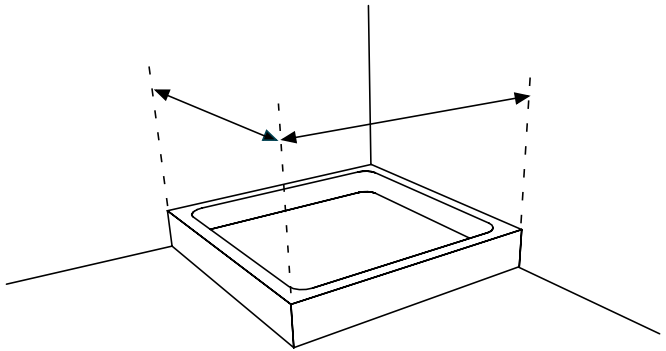

Wall Location

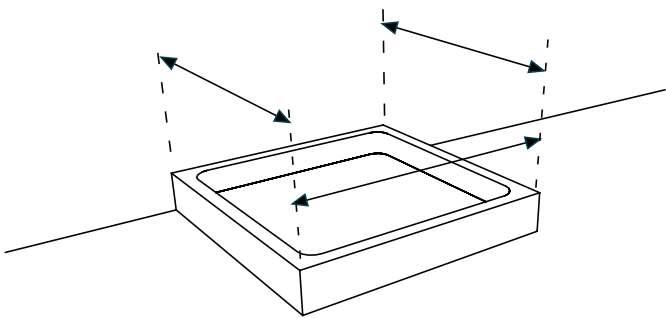

Quadrant Location

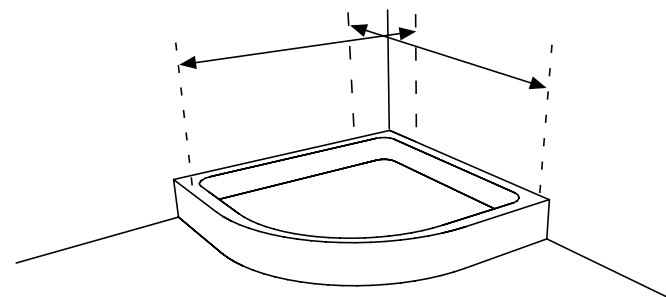

EXTENSION PROFILES

| Essence Sliding & Quadrant Doors | | | |
|----------------------------------|------------|------------------|------------------|
| Size (H) | Order Code | Price £ Exc. VAT | Price £ Inc. VAT |
| 2000mm | A0114E0 | 64.17 | 77.00 |

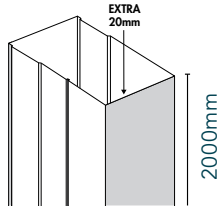

| Essence Hinge & Inline Doors | | | |
|------------------------------|------------|------------------|------------------|
| Size (H) | Order Code | Price £ Exc. VAT | Price £ Inc. VAT |
| 2000mm | A0114D0 | 64.17 | 77.00 |

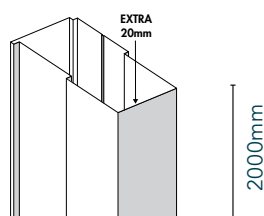

| Essence Framed Extension Profile | | | |
|----------------------------------|------------|------------------|------------------|
| Size (H) | Order Code | Price £ Exc. VAT | Price £ Inc. VAT |
| 1900mm | DWH14B0 | 64.17 | 77.00 |

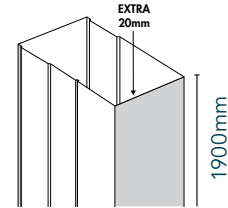

| Express Extension Profile | | | |
|---------------------------|------------|------------------|------------------|
| Size (H) | Order Code | Price £ Exc. VAT | Price £ Inc. VAT |
| 1900mm | A0314B0 | 58.24 | 69.89 |

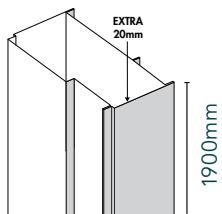

| Source Extension Profile | | | |
|--------------------------|------------|------------------|------------------|
| Size (H) | Order Code | Price £ Exc. VAT | Price £ Inc. VAT |
| 1850mm | A1214C0 | 46.38 | 55.66 |

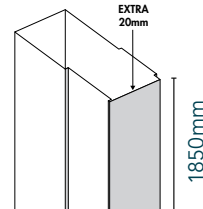

Waste positions for all Merlyn Upstands and TouchStone Trays

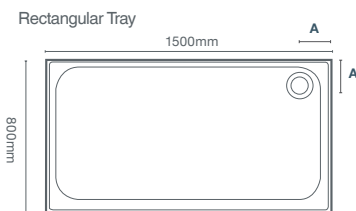

| Rectangular Tray | | | | | |
|------------------|--------|---------|--------|--------------------|--------------------|
| Size | TStone | Upstand | MStone | Waste Position (A) | Waste Position (B) |
| 800 x 700 | x | | | 147 | |
| 800 x 760 | x | | | 147 | |
| 900 x 700 | x | | | 147 | |
| 900 x 760 | | x | x | 147 | |
| 900 x 800 | x | | | 147 | |
| 1000 x 700 | x | | | 147 | |
| 1000 x 760 | x | | | 147 | |
| 1000 x 800 | x | x | x | 147 | |
| 1000 x 900 | x | | | 147 | |
| 1100 x 760 | | | x | 147 | |
| 1100 x 800 | x | | x | 147 | |
| 1200 x 700 | x | | x | 147 | |
| 1200 x 760 | x | x | x | 147 | |
| 1200 x 800 | x | x | x | 147 | |
| 1200 x 900 | x | x | x | 147 | |
| 1300 x 800 | x | | | 147 | |
| 1400 x 700 | x | | | 147 | |
| 1400 x 760 | x | | | 147 | |
| 1400 x 800 | x | | x | 147 | |
| 1400 x 900 | x | | x | 147 | |
| 1500 x 700 | x | | x | 147 | |
| 1500 x 760 | x | | | 147 | |
| 1500 x 800 | x | | x | 147 | |
| 1500 x 900 | x | | x | 147 | |
| 1600 x 700 | x | | | 147 | |
| 1600 x 800 | x | | x | 147 | |
| 1600 x 900 | x | | x | 147 | |
| 1685 x 700 | x | | x | 147 | |
| 1680 x 760 | x | | x | 147 | |
| 1700 x 800 | x | | x | 130 | 850 |
| 1700 x 900 | x | | | 130 | 850 |

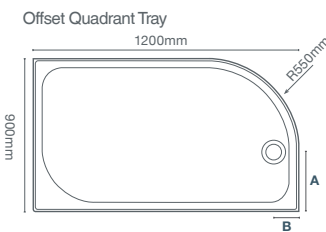

| Offset Quadrant Tray | | | | | |
|----------------------|--------|---------|--------|--------------------|--------------------|
| Size | TStone | Upstand | MStone | Waste Position (A) | Waste Position (B) |
| 900 x 760 L | | | x | 250 | 130 |
| 900 x 760 R | | | x | 250 | 130 |
| 1000 x 800 L | x | | x | 350 | 130 |
| 1000 x 800 R | x | | x | 350 | 130 |
| 1200 x 800 L | x | | x | 450 | 130 |
| 1200 x 800 R | x | | x | 450 | 130 |
| 1200 x 900 L | x | | x | 450 | 130 |
| 1200 x 900 R | x | | x | 450 | 130 |
| 1400 x 800 L | x | | | 510 | 300 |
| 1400 x 800 R | x | | | 510 | 300 |

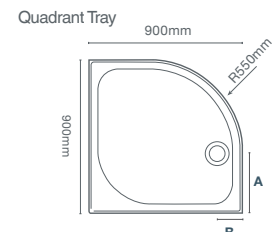

| Square Tray | | | | | |
|-------------|--------|---------|--------|--------------------|--------------------|
| Size | TStone | Upstand | MStone | Waste Position (A) | Waste Position (B) |
| 760 | x | x | x | 147 | 147 |
| 800 | x | x | x | 147 | 147 |
| 900 | x | x | x | 147 | 147 |

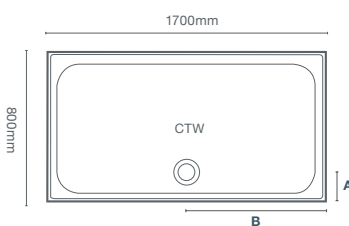
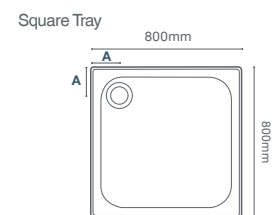

Waste is centred for 1700 x 800 (S178RTTO) and 1700 x 900 (S179TTO) trays

| Quadrant Tray | | | | | |
|---------------|--------|---------|--------|--------------------|--------------------|
| Size | TStone | Upstand | MStone | Waste Position (A) | Waste Position (B) |
| 800 | x | | x | 250 | 130 |
| 900 | x | | x | 350 | 130 |
| 1000 | | | x | 350 | 130 |

ADDITIONAL INFO IONIC EXPRESS INLINE PANELS

| Ionic Express Pivot Door and Inline Panel | | | | | |
|---|------------|--------------|----------------------|----------------|----------------|
| Size | Order Code | Door Size mm | Inline Panel Size mm | Price Exc. VAT | Price Inc. VAT |
| 650-690 | A0306A0 | 700 | - | 354.22 | 425.07 |
| 670-710 | A030001H | 700 | EXT. | 412.46 | 494.96 |
| 710-750 | A0306B0 | 760 | - | 354.22 | 425.07 |
| 750-790 | A0306D0 | 800 | - | 354.22 | 425.07 |
| 780-840 | A030002H | 700 | 150 | 567.01 | 680.41 |
| 840-900 | A030003H | 700 | 210 | 567.01 | 680.41 |
| 850-890 | A0306E0 | 900 | - | 407.68 | 489.22 |
| 900-960 | A030004H | 760 | 210 | 567.01 | 680.41 |
| 950-990 | A0306G0 | 1000 | - | 449.28 | 539.14 |
| 940-1000 | A030005H | 800 | 210 | 567.01 | 680.41 |
| 980-1040 | A030006H | 900 | 150 | 620.46 | 744.56 |
| 1040-1100 | A030007H | 900 | 210 | 620.46 | 744.56 |
| 1080-1140 | A030008H | 1000 | 150 | 662.06 | 794.48 |
| 1140-1200 | A030009H | 1000 | 210 | 662.06 | 794.48 |

| Ionic Express Bifold Door and Inline Panel | | | | | |
|--|------------|--------------|----------------------|----------------|----------------|
| Size | Order Code | Door Size mm | Inline Panel Size mm | Price Exc. VAT | Price Inc. VAT |
| 710-750 | A0300B0 | 760 | - | 397.07 | 476.49 |
| 750-790 | A0300C0 | 800 | - | 397.07 | 476.49 |
| 850-890 | A0300D0 | 900 | - | 424.32 | 509.18 |
| 900-960 | A030010H | 760 | 210 | 609.86 | 731.83 |
| 950-990 | A0300E0 | 1000 | - | 493.27 | 591.93 |
| 940-1000 | A030011H | 800 | 210 | 567.01 | 680.41 |
| 980-1040 | A030012H | 900 | 150 | 637.10 | 764.52 |
| 1040-1100 | A030013H | 900 | 210 | 637.10 | 764.52 |
| 1080-1140 | A030014H | 1000 | 150 | 662.06 | 794.48 |
| 1140-1200 | A030015H | 1000 | 210 | 706.06 | 847.27 |

| Ionic Express Sliding Door and Inline Panel | | | | | |
|---|------------|--------------|----------------------|----------------|----------------|
| Size | Order Code | Door Size mm | Inline Panel Size mm | Price Exc. VAT | Price Inc. VAT |
| 950-990 | A0304A0 | 1000 | - | 414.86 | 497.83 |
| 1050-1090 | A0304B0 | 1100 | - | 414.86 | 497.83 |
| 1080-1140 | A030016H | 1000 | 150 | 627.64 | 753.17 |
| 1140-1200 | A030017H | 1000 | 210 | 627.64 | 753.17 |
| 1150-1190 | A0304C0 | 1200 | - | 414.86 | 497.83 |
| 1180-1240 | A030018H | 1100 | 150 | 627.64 | 753.17 |
| 1240-1300 | A030019H | 1100 | 210 | 627.64 | 753.17 |
| 1280-1340 | A030020H | 1200 | 150 | 627.64 | 753.17 |
| 1340-1400 | A030021H | 1200 | 210 | 627.64 | 753.17 |
| 1350-1390 | A0304DH | 1400 | - | 533.73 | 640.47 |
| 1370-1450 | A030022H | 1100 | 150+ 210 | 840.42 | 1008.51 |
| 1450-1490 | A0304GH | 1500 | - | 568.15 | 681.78 |
| 1480-1540 | A030023H | 1400 | 150 | 746.51 | 895.81 |
| 1540-1600 | A030024H | 1400 | 210 | 746.51 | 895.81 |
| 1580-1640 | A030025H | 1500 | 150 | 780.94 | 937.12 |
| 1640-1700 | A030026H | 1500 | 210 | 780.94 | 937.12 |
| 1650-1690 | A0304HH | 1700 | - | 588.43 | 706.12 |
| 1670-1750 | A030027H | 1400 | 150 + 210 | 959.30 | 1151.16 |
| 1730-1810 | A030028H | 1400 | 210 x 2 | 959.30 | 1151.16 |
| 1780-1840 | A030029H | 1700 | 150 | 801.22 | 961.46 |
| 1840-1900 | A030030H | 1700 | 210 | 801.22 | 961.46 |

PLEASE NOTE

Prices were correct at time of print, April 2019. V.A.T. at the rate of 20%. E&OE. Due to circumstances beyond our control, prices may be altered including changes to the rate of V.A.T.

Due to our policy of continuous improvement, we reserve the right to amend prices, specifications and designs without prior notice. Images are for illustrated purposes only. The colours and finishes shown in the catalogue are

as accurate as possible within the limits of the printing process. All descriptions, specifications and particulars contained in this brochure are intended merely to represent a general idea of the products described herein and none of these form part of any contract to give rise to any independent or collateral liability upon the company.

MERLYN

Unit 8, Purocellsinch Industrial Park, Dublin Road, Kilkenny, Ireland, R95 HP71.

T 0808 1011 429 / F 0808 1011 428

www.merlynshowering.com



MERLYN IONIC



MERLYN

series



it's all about the experience

THE SERIES COLLECTION



MERLYN

series



65% of consumers who bought a MERLYN shower designed their bathroom around it making the shower the focal point of the bathroom

(source: Dolmen research UK December 2017)

Contents

about.

| | |
|---------------------------|----|
| Welcome to MERLYN | 04 |
| The Series Collection | 06 |
| Mersfield Stayclear | 08 |
| MERLYN Lifetime Guarantee | 09 |

products.

| | |
|-------------------------|----|
| 10 Series | 11 |
| 8 Series Frameless | 23 |
| 8 Series | 37 |
| 6 Series Frameless | 49 |
| 6 Series | 53 |
| Wetrooms | 65 |
| SecureSeal Bath Screens | 78 |
| Bath Screens | 82 |
| TrueStone Trays | 88 |
| Level25 Trays | 91 |
| MStone Trays | 94 |

technical information.

| | |
|---------------------|----|
| Product Information | 98 |
|---------------------|----|

welcome to MERLYN

We've built our name and reputation on a simple ethos... to deliver on everything we promise to our customers. This is because you are at the heart of everything we do.

We have a relentless desire to deliver the highest level of attention to detail, and our award-winning customer service department – and the wider MERLYN team – live this ethos every single day.

We're passionate about innovation, quality and design, and this is reflected throughout our ranges.

Our unique approach has resulted in us becoming the No.1 shower enclosure brand in the UK and Ireland, with 5 million people enjoying a MERLYN shower experience every day.

When you choose a MERLYN shower you are investing in one of the world's most luxurious showering environments and you get the added peace of mind of our Lifetime Guarantee.

Thank you for choosing MERLYN.

The MERLYN Team

Award Winning Customer Service

It is not about what we do but what we can do for you.

We promise we will always be there for you at any stage of your journey with MERLYN. We have a genuine commitment to service and to finding a solution for you. Our specialised team's philosophy is to make everything easy for you and we will respond immediately to any request you might have.

We strive everyday to make excellence a habit.

Contact our award winning dedicated team of specialists, who are on hand to give you a personalised solution to your query.
UK Freephone Number **0808 101 1429** | WhatsApp **00353 86 010002**

Online: sales@merlyn.ie | or via our Web Chat at merlynshowering.com



passion to be precise.

Behind the exceptional products MERLYN produce, is a team of world class design innovators.

For us, it's all about providing the ultimate showering experience - from the smooth running of our shower doors, to the beautiful lines of our design and the quality of our fittings. We are proud to say our unique approach has resulted in us being the UK and Ireland's No.1 showering company for enclosures and trays.



the series collection

It's all about the experience

Made up of shower enclosures, trays and bath screens, the MERLYN Series Collection is all about providing the ultimate showering experience - from the smooth running of the shower doors to the beautiful and elegant design and the quality of fittings.

6 | series

Affordable Quality



A beautifully styled product range with smooth and soft rolling action.

- Height 1900mm
- 6mm Glass Thickness

6 | series

frameless

Exceptional Value



Elegant and frameless designer range with beautifully crafted, unique one-piece hinges.

- Height 2000mm
- 6mm and 8mm Glass Thickness

8 | series

Style & Functionality



This product range is all about the feeling. With robust rolling action and a beautifully crafted sleek framed style.

- Height 1950mm
- 8mm Glass Thickness

8 | series

frameless

Elegantly minimalist



Considered the most beautiful frameless 8mm product range. With stunning design symmetry of unique one-piece hinge and towel rail handle, offering maximum access.

- Height up to 2000mm
- 8mm Glass Thickness

10 | series

Exquisite design



Exquisite, towering 10mm product range. Balance of beauty and movement giving the user a sense of pure luxury.

- Height up to 2100mm
- 10mm Glass Thickness
- Bespoke options available
- Smoked Glass option available

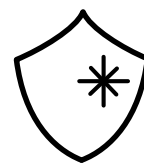

MERSHIELD
STAYCLEAR

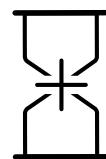

LIFETIME
GUARANTEE



Without
Mershield Stayclear

With
Mershield Stayclear



Natural glass surface.



Mershield Stayclear coating creates a smooth layer over the surface of natural glass, lowering surface friction, making it easier for water, soap and lime deposits to run off the glass.



MERSHIELD
STAYCLEAR

Mershield *Stayclear*

MERLYN treats every product in the Series Collection with a special protective coating to ensure the glass maintains its sparkle. This comes as standard as part of our on-going commitment to service.

Mershield Stayclear acts as a protective coating which when applied to glass, helps the glass to remain shiny and new without the need for tiresome cleaning. When cleaned correctly it helps prevent the build up of limescale and soap deposits making the shower glass "easy to clean". Please see tips for keeping the glass in pristine condition.

Without Mershield Stayclear Protective Coating

Without Mershield Stayclear protection, water and soap deposits cling to the glass surface causing a build up of grime, requiring more vigorous cleaning.

With Mershield Stayclear Protective Coating

The Mershield Stayclear coating provides a larger contact angle for the water droplets on the surface and makes the drops smaller than drops falling on an untreated surface. This ensures the droplets roll away much faster down the surface, minimising deposits left behind.

Tips on how to
keep your MERLYN
glass in pristine
condition:

- It is important to clean your glass after every use - wipe down with a soft cloth.
- Install the enclosure in a well ventilated area.
- Do not allow limescale to build up in hard water areas.
- Ensure any residual water on the glass is removed after every use.
- Clean the glass regularly using soapy water.
- DO NOT use abrasive products on any surfaces.

MERLYN

lifetime guarantee



MERLYN is committed to developing products that meet the highest demands in terms of design, performance and quality.

Due to our extreme confidence in our products and our unrelenting desire to deliver only the highest level of service, we have created the MERLYN Lifetime Guarantee.

MERLYN shower enclosures are crafted and engineered for a lifetime.

For more about our MERLYN Lifetime Guarantee, contact our MERLYN customer service team on 0808 101 1429.

Register your MERLYN product:

To register your new MERLYN product for the Lifetime Guarantee, log on to www.merlynshowering.com and fill in your information.



www.merlynshowering.com





Sliding Door with Side Panel / Smoked Black option

10^{MM}
GLASS
THICKNESS

LIFETIME
GUARANTEE

MERSHIELD
STAYCLEAR

10 | series

This range is the flagship of the MERLYN Series Collection, it exudes the very finest in style, luxury and quality. These beautifully designed solid doors can be personalised to suit any space and design requirements.

Why choose 10 Series?



Up to 10mm glass

Adding to the quality feel of this range, 10 Series products are manufactured using up to 10mm toughened safety glass. Smoked Black Glass option available.

Towering glass height

With up to an impressive 2100mm glass height, 10 Series gives you an amazing sense of space when showering.

A choice of handles

The 10 Series range gives you a choice of handles to suit your own personal style with both a chrome circular handle and an eyelet handle as standard with your enclosure.



Tested for quality & safety

All products are rigorously tested by us and by global health and safety experts to make sure they adhere to the highest quality standards (CE mark info page 101).



Quiet glide wheels

Using MERLYN'S years of engineering experience, the 10 Series also features a quiet glide wheel which softly opens and closes with minimum effort.

*Please refer to adjustments and height before purchase



Sliding Door with Side Panel / Shown as Right Hand (R)

Sliding Door in a Recess

technical drawing.





A: Opening size can be adjusted to your requirements
 B: Fixed Panel

A total of 35mm adjustment (max of 12mm adjustment in wall profile on closing side for out of true walls i.e. on right hand side of image shown).

| Size | A Min-Max | B |
|------|--------------|------|
| 1000 | 405-300 | 510 |
| 1100 | 455-350 | 560 |
| 1200 | 505-400 | 610 |
| 1400 | 605-500 | 710 |
| 1600 | 605-500 | 910 |
| 1700 | 605-500 | 1010 |

glass options.

-  Clear
-  Smoked Black

10^{MM}
GLASS
THICKNESS

LIFETIME
GUARANTEE

MERSHIELD
STAYCLEAR

Sliding Door

This spectacular enclosure makes a definite style statement. Contemporary style lovers will delight in the optional Smoked Black glass and its roller action. While minimalist in appearance this sliding door has an impressive 10mm toughened glass, making it the flagship of the MERLYN Series Collection range.

features.

- Height 2100mm
- Eyelet handle with chrome eyelet option and circular filler plate option
- Smoked Black glass option
- Extra smooth roller action for quiet closing
- Door handed - order Left Hand (L) or Right Hand (R)
- Wetroom compatible
- Bespoke options available, see page 21.

| Sliding Door | | | | | | Add a MERLYN MStone Tray | | |
|--------------|------------------------|--------------|---------------------|------------------|------------------|--------------------------|------------------|------------------|
| Size | Tray Finish Adjustment | Glass Type | Order Code | Price £ Exc. VAT | Price £ Inc. VAT | Order Code* | Price £ Exc. VAT | Price £ Inc. VAT |
| 1000 | 950-985 | Clear | M108231C Lor R | 1371.21 | 1645.45 | MS108231C Lor R | 1575.52 | 1890.63 |
| 1100 | 1050-1085 | Clear | M108251C Lor R | 1371.21 | 1645.45 | MS108251C Lor R | 1600.25 | 1920.29 |
| 1200 | 1150-1185 | Clear | M108241C Lor R | 1371.21 | 1645.45 | MS108241C Lor R | 1585.92 | 1903.10 |
| 1200 | 1150-1185 | Smoked Black | M108241B Lor R | 1615.08 | 1938.09 | MS108241B Lor R | 1829.79 | 2195.75 |
| 1400 | 1350-1385 | Clear | M108291C Lor R | 1430.81 | 1716.97 | MS108291C Lor R | 1753.22 | 2103.86 |
| 1400 | 1350-1385 | Smoked Black | M108291B Lor R | 1677.10 | 2012.52 | MS108291B Lor R | 1999.51 | 2399.41 |
| 1500 | 1450-1485 | Clear | M108281C Lor R | 1558.96 | 1870.75 | MS108281C Lor R | 1926.48 | 2311.77 |
| 1600 | 1550-1585 | Clear | M108271C Lor R | 1589.82 | 1907.78 | MS108271C Lor R | 2022.32 | 2426.79 |
| 1700 | 1650-1685 | Clear | M1081700CH Lor R | 1621.95 | 1946.34 | MS1081700CH Lor R | 2138.05 | 2565.66 |

*Order code for ordering shower enclosure with tray.
This product is handed please choose L for left and R for right when ordering.
Please add 15mm to Tray Finish Adjustment when using a Side Panel.

Optional Side Panel

| Size | Tray Finish Adjustment | Glass Type | Order Code | Price £ Exc. VAT | Price £ Inc. VAT |
|------|------------------------|--------------|------------|------------------|------------------|
| 760 | 730-750 | Clear | M102210C | 622.69 | 747.23 |
| 800 | 770-790 | Clear | M102211C | 622.69 | 747.23 |
| 800 | 770-790 | Smoked Black | M102211B | 823.61 | 988.33 |
| 900 | 870-890 | Clear | M102221C | 622.69 | 747.23 |
| 900 | 870-890 | Smoked Black | M102221B | 863.53 | 1036.24 |

Please Note: Moving panel door must close onto the side panel.
For wetroom installation, please reduce Side Panel Tray Finish Adjustment by 20mm.



1 Door Offset Quadrant / Shown as Right Hand (R)

technical drawing.

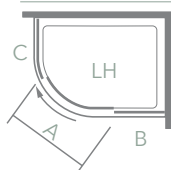

| Size | A Min-Max | B | C |
|----------|--------------|-----|-----|
| 1000x800 | 435-340 | 435 | 520 |
| 1200x800 | 435-340 | 635 | 520 |
| 1200x900 | 485-390 | 635 | 570 |
| 1400x800 | 435-340 | 835 | 520 |

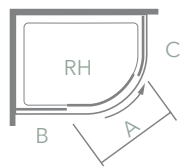

A: Opening size can be adjusted to your requirements
 B: Straight Panel
 C: Curved Panel

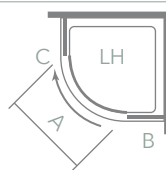

| Size | A Min-Max | B | C |
|------|--------------|-----|-----|
| 800 | 435-340 | 235 | 535 |
| 900 | 485-390 | 340 | 575 |

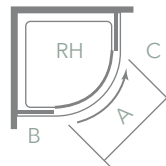

All sizes suit 550mm radius tray.
 Note: Curved Panels 8mm glass.
 Extension profiles available. See Page 99.

10
MM
GLASS
THICKNESS

LIFETIME
GUARANTEE

MERSHIELD
STAYCLEAR

1 Door Quadrants

Beautifully curved glass combined with an exceptionally smooth roller action makes this quadrant door the best in its class. Constructed from up to 10mm toughened glass with the option of Smoked Black glass, this stunning enclosure offers strength and practicality which belies its beauty.

features.

- Height 2000mm
- Up to 10mm toughened glass
- Eyelet handle with chrome eyelet option and circular filler plate option
- Smoked Black glass option
- Extra smooth roller action for quiet closing
- Door handed - order Left Hand (L) or Right Hand (R)
- Wetroom compatible



1 Door Offset Quadrant / Smoked Black



1 Door Quadrant / Shown as Left Hand (L)

glass options.



Clear



Smoked Black

| 1 Door Offset Quadrant | | | | | | Add a MERLYN MStone Tray | | |
|------------------------|------------------------|--------------|--------------------|-----------------|-----------------|--------------------------|-----------------|-----------------|
| Size | Tray Finish Adjustment | Glass Type | Order Code | Price £ Exc.VAT | Price £ Inc.VAT | Order Code* | Price £ Exc.VAT | Price £ Inc.VAT |
| 1000x800 | 975-995 775-795 | Clear | M103233C L or R | 1721.58 | 2065.90 | MS103233C L or R | 1954.53 | 2345.44 |
| 1200x800 | 1175-1195 775-795 | Clear | M103243C L or R | 1913.28 | 2295.94 | MS103243C L or R | 2157.92 | 2589.50 |
| 1200x900 | 1175-1195 875-895 | Clear | M103241C L or R | 1914.38 | 2297.26 | MS103241C L or R | 2172.05 | 2606.46 |
| 1200x900 | 1175-1195 875-895 | Smoked Black | M103241B L or R | 2088.29 | 2505.95 | MS103241B L or R | 2345.96 | 2815.15 |
| 1400x800 | 1375-1395 775-795 | Clear | M10148H L or R | 2046.28 | 2455.54 | M10148HB L or R | 2332.40 | 2798.88 |

*Order code for ordering shower enclosure with tray.
This product is handed please choose L for left and R for right when ordering.

MERLYN Dedicated Offset Quadrant Tray (1400x800)

| Size | Order Code | Price £ Exc. VAT | Price £ Inc. VAT |
|----------|-----------------|------------------|------------------|
| 1400x800 | S148Q L or R | 286.11 | 343.34 |

Please Note: The 1400mmx800mm tray is not an MStone Tray, it is a dedicated single skinned tray.
For wetroom installation, please reduce Side Panel Tray Finish Adjustment by 20mm.

| 1 Door Quadrant | | | | | | Add a MERLYN MStone Tray | | |
|-----------------|------------------------|--------------|--------------------|-----------------|------------------|--------------------------|-----------------|------------------|
| Size | Tray Finish Adjustment | Glass Type | Order Code | Price £ Exc.VAT | Price £ Inc. VAT | Order Code* | Price £ Exc.VAT | Price £ Inc. VAT |
| 800 | 775-795 | Clear | M103211C L or R | 1693.28 | 2031.93 | MS103211C L or R | 1858.55 | 2230.26 |
| 900 | 875-895 | Clear | M103221C L or R | 1662.65 | 1995.18 | MS103221C L or R | 1843.55 | 2212.26 |
| 900 | 875-895 | Smoked Black | M103221B L or R | 1910.33 | 2292.40 | MS103221B L or R | 2091.24 | 2509.49 |

*Order code for ordering shower enclosure with tray.
For wetroom installation, please reduce Side Panel Tray Finish Adjustment by 10mm.



Pivot Door / Shown in a Recess



Pivot Door / Shown with Side Panel

technical drawing.

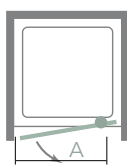

A: Door Opening
B: Door Swing

| Size | A Min-Max | B |
|------|--------------|-----|
| 800 | 560 | 580 |
| 900 | 660 | 680 |
| 1000 | 760 | 780 |

Note: 10mm adjustment only on closing side.
Extension profiles available. See Page 99.

10^{MM}
GLASS
THICKNESS

LIFETIME
GUARANTEE

MERSHIELD
STAYCLEAR

Pivot Door

The 10 Series Pivot Door is bound to impress in any bathroom. Its substantial 10mm toughened glass and solid chrome angular double handle provide a style statement that befits the beauty of this door.

features.

- Height 2030mm
- Solid chrome handle
- Fully concealed fixings
- Reversible
- Wetroom compatible

| Pivot Door in a recess | | | | | | Add a MERLYN MStone Tray | | |
|------------------------|------------------------|------------|------------|------------------|------------------|--------------------------|------------------|------------------|
| Size | Tray Finish Adjustment | Glass Type | Order Code | Price £ Exc. VAT | Price £ Inc. VAT | Order Code* | Price £ Exc. VAT | Price £ Inc. VAT |
| 800 | 760-790 | Clear | M101211C | 1172.54 | 1407.05 | MS101211C | 1301.37 | 1561.64 |
| 900 | 860-890 | Clear | M101221C | 1181.76 | 1418.11 | MS101221C | 1362.66 | 1635.19 |
| 1000 | 960-990 | Clear | M101231C | 1242.36 | 1490.84 | MS101231C | 1446.67 | 1736.01 |

*Order code for ordering shower enclosure with tray.

Please reduce Tray Finish Adjustment by 10mm when using a Side Panel.

Optional Side Panel

| Size | Tray Finish Adjustment | Glass Type | Order Code | Price £ Exc. VAT | Price £ Inc. VAT |
|------|------------------------|------------|------------|------------------|------------------|
| 800 | 770-790 | Clear | M10P2211C | 582.76 | 699.32 |
| 900 | 870-890 | Clear | M10P2221C | 608.96 | 730.75 |
| 1200 | 1170-1190 | Clear | M10P2241C | 747.48 | 896.98 |

Please Note: Moving panel door must close onto the Side Panel.

For wetroom installation, please reduce Side Panel Tray Finish Adjustment by 30mm.



Pivot Door & Inline Panel / Shown with Side Panel

technical drawing.



A: Door Opening
 B: Door Swing
 C: Inline Panel

| Size | A Min-Max | B | C |
|------|--------------|-----|-----|
| 1200 | 560 | 580 | 410 |
| 1400 | 560 | 580 | 610 |
| 1500 | 660 | 680 | 810 |
| 1600 | 560 | 580 | 810 |
| 1700 | 660 | 680 | 810 |
| 1800 | 760 | 780 | 810 |

Extension profiles available. See Page 99.



10^{MM}
GLASS
THICKNESS

LIFETIME
GUARANTEE

MERSHIELD
STAYCLEAR

Pivot Door & Inline Panel

MERLYN'S 10 Series Pivot Door & Inline Panel is a luxurious showering choice with solid chrome double handle and 10mm toughened safety glass. Flexible size options available from 1200mm to 1800mm.

features.

- Height 2030mm
- Solid chrome handle
- Fully concealed fixings
- Reversible
- Wetroom compatible

| Pivot Door and Inline Panel (Glass Type: Clear) | | | | | | | Add a MERLYN MStone Tray | | |
|---|------------------------|-----------------------------|-------------------------------------|------------|------------------|------------------|--------------------------|------------------|------------------|
| Size | Tray Finish Adjustment | Size of Pivot Door Supplied | Size of Pivot Inline Panel Supplied | Order Code | Price £ Exc. VAT | Price £ Inc. VAT | Order Code* | Price £ Exc. VAT | Price £ Inc. VAT |
| 1200 | 1150-1190 | 800 | 400 | M101241C | 1615.20 | 1938.24 | MS101241C | 1829.91 | 2195.89 |
| 1400 | 1350-1390 | 800 | 600 | M101291C | 1694.23 | 2033.08 | MS101291C | 2005.18 | 2406.22 |
| 1500 | 1450-1490 | 900 | 600 | M101261C | 1703.46 | 2044.15 | MS101261C | 2070.97 | 2485.17 |
| 1600 | 1550-1590 | 800 | 800 | M101271C | 1789.11 | 2146.93 | MS101271C | 2221.62 | 2665.94 |
| 1700 | 1650-1690 | 900 | 800 | M101281C | 1798.33 | 2157.99 | MS101281C | 2234.82 | 2681.78 |
| 1800 | 1750-1790 | 1000 | 800 | M101218C | 1858.88 | 2230.65 | - | - | - |

*Order code for ordering shower enclosure with tray.

| Optional Pivot Door and Inline Panel Side Panel | | | | | | |
|---|------------------------|------------|------------|------------------|------------------|--|
| Size | Tray Finish Adjustment | Glass Type | Order Code | Price £ Exc. VAT | Price £ Inc. VAT | |
| 800 | 770-790 | Clear | M10PI2211C | 577.77 | 693.33 | |
| 900 | 870-890 | Clear | M10PI2221C | 622.69 | 747.23 | |

For wetroom installation, please reduce Side Panel Tray Finish Adjustment by 10mm.
Please Note: Moving panel door must close onto the Inline Panel.



Bespoke Sliding Door and Side Panel with Satin glass and increased height / Shown as Left Hand (L)



10^{MM}
GLASS
THICKNESS



LIFETIME
GUARANTEE



MERSHIELD
STAYCLEAR

Bespoke

- Sliding Door

Create the perfect Sliding Door to suit your space. MERLYN offer bespoke sizes for the 10 Series Sliding Door and Side Panels. With extra heights, widths and glass colour options to choose from, it's time to make your MERLYN shower truly unique to you.

For a detailed quote please contact MERLYN directly on 0808 101 1429.

Glazing Options

There are 4 glass options to choose from: Standard Clear, Smoked Black, Satin and Opti-White. Please note these are additionally priced options.

Ordering Bespoke Products

To order a bespoke product please supply a drawing with accurate measurements to MERLYN at sales@merlyn.ie or call the customer service team directly on 0808 101 1429. Please contact MERLYN for additional delivery charges on side panel sizes over 1200mm and further terms and conditions.

Bespoke Heights.

Max height available is 2200mm with minimum height of 1900mm.

Bespoke Widths.

Max width available on Sliding Door and Fixed Panel is 2000mm. Side Panels can be created from 300mm wide up to max width of 2200mm.

Glass Options.

-  Standard
-  Smoked Black
-  Satin
-  Opti-White





8^{MM}
GLASS
THICKNESS

LIFETIME
GUARANTEE

MERSHIELD
STAYCLEAR

8 | series | *frameless*

If your bathroom is crying out for an enclosure that has a minimalist designer frame the 8 Series Frameless range is perfect. With its chrome hinges and handles, it's the perfect complement for any modern styled bathroom.

8 | series
frameless

Why choose 8 Series frameless?

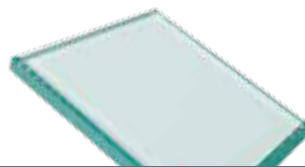

8mm glass

The 8 Series Frameless range features stunning 8mm frameless glass, standing at the impressive height of 2000mm.



MERLYN signature badging

For the designer look, the minimalist frame is complemented with subtle MERLYN embossing. A true mark of quality for you to showcase in your bathroom.

Horizontal designer handle

The Hinged and Quadrant shapes in this range feature our exclusive horizontal handle which offers the perfect symmetry and solid feel to this truly stunning range.



Tested for quality & safety

All products are rigorously tested by us and by global health and safety experts to make sure they adhere to the highest quality standards (CE mark info page 101).

Ultra slim hinges

Complementing the designer minimalist look, the ultra sleek one piece hinges on our 8 Series Frameless range are our most innovative to date. The internal mechanics are concealed fully in one elegant chrome plate, which gives you a secure showering environment with added style.





Pivot Door / Shown with Side Panel

Pivot Door / Shown in a Recess

technical drawing.

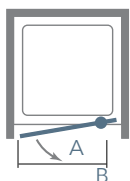

A: Door Opening
B: Door Swing

| Size | A | B |
|------|-----|-----|
| 760 | 642 | 640 |
| 800 | 682 | 680 |
| 900 | 782 | 780 |
| 1000 | 882 | 880 |

Note: 10mm adjustment only on closing side.
Extension profiles available. See Page 99.



Pivot Door

The 8 Series Frameless Pivot Door is practical, stylish and the perfect solution for recess and corner situations. At a height of 1950mm, this enclosure is the perfect choice.

features.

- Height 1950mm
- Solid chrome double handle
- Cover caps
- Space saving solution
- Inward and outward opening swing
- Concealed fixings
- Reversible
- Wetroom compatible

| Pivot Door in a Recess | | | | | Add a MERLYN MStone Tray | | |
|------------------------|------------------------|------------|------------------|------------------|--------------------------|------------------|------------------|
| Size | Tray Finish Adjustment | Order Code | Price £ Exc. VAT | Price £ Inc. VAT | Order Code* | Price £ Exc. VAT | Price £ Inc. VAT |
| 760 | 730-760 | S8FPV76 | 529.00 | 634.80 | S8FPV76B | 640.36 | 768.43 |
| 800 | 770-800 | S8FPV80 | 559.00 | 670.80 | S8FPV80B | 672.88 | 807.46 |
| 900 | 870-900 | S8FPV90 | 579.00 | 694.80 | S8FPV90B | 752.94 | 903.53 |
| 1000 | 970-1000 | S8FPV100 | 599.00 | 718.80 | S8FPV100B | 795.46 | 954.55 |

*Order code for ordering shower enclosure with tray.

| Optional Pivot Door Side Panel | | | | |
|--------------------------------|------------------------|------------|------------------|------------------|
| Size | Tray Finish Adjustment | Order Code | Price £ Exc. VAT | Price £ Inc. VAT |
| 760 | 735-755 | S8FSP76PV | 432.00 | 518.40 |
| 800 | 775-795 | S8FSP80PV | 432.00 | 518.40 |
| 900 | 875-895 | S8FSP90PV | 458.00 | 549.60 |
| 1000 | 975-995 | S8FSP100PV | 525.00 | 630.00 |
| 1200 | 1175-1195 | S8FSP120PV | 595.00 | 714.00 |

For wetroom installation, please reduce Side Panel Tray Finish Adjustment by 10mm.



Pivot and Inline / Overhead
Shown with a Side Panel **Inward Swing**



Pivot and Inline / Overhead
Shown with a Side Panel **Outward Swing**



Pivot and Inline / Shown in a Recess

Pivot and Inline / Shown with Side Panel

technical drawing.

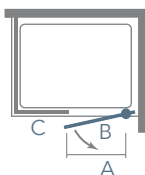

A: Door Opening
B: Door Swing
C: Inline Panel

Extension profiles available.
See Page 99.

Side Panel

| Enclosure Size | Door Size | Inline Size | A | B | C |
|----------------|-------------|-------------|-----|-----|-----|
| 1000 | 800 | 200 | 682 | 680 | 225 |
| 1100 | 800 | 300 | 682 | 680 | 235 |
| | 900 | 200 | 782 | 780 | 225 |
| 1200 | 800 | 400 | 682 | 680 | 425 |
| | 900 | 300 | 782 | 780 | 325 |
| 1300 | 1000 | 200 | 882 | 880 | 225 |
| | 800 | 500 | 682 | 680 | 525 |
| 1400 | 900 | 400 | 782 | 780 | 425 |
| | 1000 | 300 | 882 | 880 | 325 |
| 1500 | 900 | 500 | 782 | 780 | 524 |
| | 1000 | 400 | 882 | 880 | 425 |
| 1500 | 1000 | 500 | 882 | 880 | 525 |

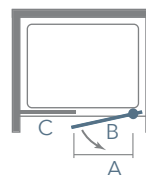

A: Door Opening
B: Door Swing
C: Inline Panel

Recess

| Enclosure Size | Door Size | Inline Size | A | B | C |
|----------------|-------------|-------------|-----|-----|-----|
| 1000 | 800 | 200 | 682 | 680 | 218 |
| 1100 | 800 | 300 | 682 | 680 | 318 |
| | 900 | 200 | 782 | 780 | 218 |
| 1200 | 800 | 400 | 682 | 680 | 418 |
| | 900 | 300 | 782 | 780 | 318 |
| 1300 | 1000 | 200 | 882 | 880 | 218 |
| | 800 | 500 | 682 | 680 | 518 |
| 1400 | 900 | 400 | 782 | 780 | 418 |
| | 1000 | 300 | 882 | 880 | 318 |
| 1500 | 900 | 500 | 782 | 780 | 518 |
| | 1000 | 400 | 882 | 880 | 418 |
| 1500 | 1000 | 500 | 882 | 880 | 518 |



Pivot Door & Inline Panel

This new addition to the 8 Series Frameless range brings with it choice and a range of size options to fit a varied space. This beautiful enclosure epitomises style and practicality.

features.

- Height 1950mm
- Solid chrome double handle
- Cover caps
- Space saving solution
- Inward and outward opening swing
- Concealed fixings
- Reversible
- Wetroom compatible

| Pivot Door and Inline Panel in a Recess | | | | | | | Add a MERLYN MStone Tray | | |
|---|--------------------|---------------|------------------------|------------|------------------|------------------|--------------------------|------------------|------------------|
| Size | Size of Pivot Door | Inline Panels | Tray Finish Adjustment | Order Code | Price £ Exc. VAT | Price £ Inc. VAT | Order Code* | Price £ Exc. VAT | Price £ Inc. VAT |
| 1000 | 800 | 200 | 960-1000 | S8FPI1002H | 798.00 | 957.60 | S8FPI1002HB | 1002.32 | 1202.78 |
| 1100 | 800 | 300 | 1060-1100 | S8FPI1103H | 818.00 | 981.60 | S8FPI1103HB | 1035.33 | 1242.39 |
| | | | | S8FPI1102H | 818.00 | 981.60 | S8FPI1102HB | 1035.33 | 1242.39 |
| 1200 | 800 | 400 | 1160-1200 | S8FPI1204H | 838.00 | 1005.60 | S8FPI1204HB | 1052.71 | 1263.25 |
| | | | | S8FPI1203H | 838.00 | 1005.60 | S8FPI1203HB | 1052.71 | 1263.25 |
| | | | | S8FPI1202H | 838.00 | 1005.60 | S8FPI1202HB | 1052.71 | 1263.25 |
| ** 1300 | 800 | 500 | 1260-1300 | S8FPI1305H | 858.00 | 1029.60 | S8FPI1305HB | 1101.25 | 1321.50 |
| | | | | S8FPI1304H | 858.00 | 1029.60 | S8FPI1304HB | 1101.25 | 1321.50 |
| | | | | S8FPI1303H | 858.00 | 1029.60 | S8FPI1303HB | 1101.25 | 1321.50 |
| 1400 | 900 | 500 | 1360-1400 | S8FPI1405H | 878.00 | 1053.60 | S8FPI1405HB | 1188.00 | 1425.60 |
| | | | | S8FPI1404H | 878.00 | 1053.60 | S8FPI1404HB | 1188.00 | 1425.60 |
| 1500 | 1000 | 500 | 1460-1500 | S8FPI1505H | 898.00 | 1077.60 | S8FPI1505HB | 1251.83 | 1502.20 |

Please Note: Items in bold are our recommended configurations.

*Order Code for ordering shower enclosure with tray.

**Available with TouchStone Tray Only

Please Note: If you would like the door to open fully against the wall please refer to the sizes in panel B (door swing) in the relevant table on page 26.

| Optional Pivot Door and Inline Side Panel | | | | |
|---|------------------------|------------|------------------|------------------|
| Size | Tray Finish Adjustment | Order Code | Price £ Exc. VAT | Price £ Inc. VAT |
| 760 | 735-755 | S8FSP76IN | 432.00 | 518.40 |
| 800 | 775-795 | S8FSP80IN | 432.00 | 518.40 |
| 900 | 875-895 | S8FSP90IN | 458.00 | 549.60 |

For more information on the Side Panel refer to the technical drawing page 26.

For wetroom installation, please reduce Side Panel Tray Finish Adjustment by 10mm.

8 Series
frameless



Sliding Door / Shown with Side Panel

technical drawing.

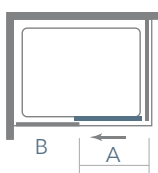

A: Door Opening
B: Fixed Panel

| Size | A | B |
|------|-----|-----|
| 1200 | 450 | 565 |
| 1400 | 550 | 665 |

8^{MM}
GLASS
THICKNESS

LIFETIME
GUARANTEE

MERSHIELD
STAYCLEAR

Sliding Door

The 8 Series Frameless Sliding Door has the smoothest rolling action that needs to be seen to be believed. With its sleek minimalist frame and stunning designer features; it will bring a touch of class to any bathroom.

features.

- Height 2000mm
- Concealed fixings
- Mershield Stayclear easy clean protected glass
- Translucent seals
- Reversible
- Wetroom compatible
- Lifetime Guarantee

| Sliding Door | | | | | Add a MERLYN MStone Tray | | |
|--------------|------------------------|------------|---------------------|---------------------|--------------------------|---------------------|---------------------|
| Size | Tray Finish Adjustment | Order Code | Price £ Exc. VAT | Price £ Inc. VAT | Order Code* | Price £ Exc. VAT | Price £ Inc. VAT |
| 1200 | 1150-1190 | A0920DH | 902.53 | 1083.03 | AS0920DH | 1122.46 | 1346.95 |
| 1400 | 1350-1390 | A0920HH | 1039.88 | 1247.85 | AS0920HH | 1362.28 | 1634.73 |

*Order Code for ordering shower enclosure and tray.
Please add 20mm to Tray Finish Adjustment when using a Side Panel.

| Optional Side Panel | | | | |
|---------------------|------------------------|------------|---------------------|---------------------|
| Size | Tray Finish Adjustment | Order Code | Price £ Exc. VAT | Price £ Inc. VAT |
| 800 | 765-790 | A0920LH | 472.23 | 566.67 |
| 900 | 865-890 | A0920PH | 500.91 | 601.10 |

For wetroom installation, please reduce Side Panel Tray Finish Adjustment by 20mm.

8 | SERIES
frameless



Hinge and Inline / Shown in a Recess



Hinge and Inline / Shown with Side Panel

technical drawing.



A: Door Opening
 B: Door Swing
 C: Inline Panel

Extension profiles available. See Page 99.

| Size | A | B | C |
|-------|-----|-----|-----|
| 900 | 560 | 630 | 240 |
| 900+ | 560 | 630 | 285 |
| 1000 | 645 | 710 | 260 |
| 1000+ | 690 | 755 | 260 |
| 1100 | 645 | 710 | 360 |
| 1100+ | 690 | 755 | 360 |
| 1200 | 645 | 710 | 460 |

| Size | A | B | C |
|-------|-----|-----|-----|
| 1200+ | 690 | 755 | 460 |
| 1400 | 645 | 710 | 660 |
| 1400+ | 690 | 755 | 660 |
| 1600 | 645 | 710 | 860 |
| 1600+ | 690 | 755 | 860 |
| 1700 | 645 | 710 | 960 |
| 1700+ | 690 | 755 | 960 |

8^{MM}
GLASS
THICKNESS

LIFETIME
GUARANTEE

MERSHIELD
STAYCLEAR

Hinge and Inline

A hugely practical yet stylish option, the 8 Series Frameless Hinge & Inline in a Recess is perfect for recesses or en suites. The Hinge and Inline redefines the art of showering with its creative fusion of style and practicality.

features.

- Height 2000mm
- Large horizontal designer handle including internal clutch bar handle
- Secure "Clunk" closing
- Ultra slim hinges
- Concealed fixings
- Reversible
- Wetroom compatible

| Hinge and Inline in a Recess | | | | | Add a MERLYN MStone Tray | | |
|------------------------------|------------------------|------------|------------------|------------------|--------------------------|------------------|------------------|
| Size | Tray Finish Adjustment | Order Code | Price £ Exc. VAT | Price £ Inc. VAT | Order Code* | Price £ Exc. VAT | Price £ Inc. VAT |
| 900 | 860-905 | A0611X0 | 1054.83 | 1265.80 | A0611X0B | 1235.73 | 1482.88 |
| 900+ | 905-950 | A0611Y0 | 1054.83 | 1265.80 | | | |
| 1000 | 960-1005 | A0611RH | 1054.83 | 1265.80 | A0611RHB | 1259.15 | 1510.97 |
| 1000+ | 1005-1050 | A0611RF | 1054.83 | 1265.80 | | | |
| 1100 | 1060-1105 | A0611SH | 1127.00 | 1352.40 | A0611SHB | 1343.83 | 1612.60 |
| 1100+ | 1105-1150 | A0611SF | 1127.00 | 1352.40 | | | |
| 1200 | 1160-1205 | A0611TH | 1142.96 | 1371.55 | A0611THB | 1357.67 | 1629.20 |
| 1200+ | 1205-1250 | A0611TF | 1142.96 | 1371.55 | | | |
| 1400 | 1360-1405 | A0611UH | 1434.86 | 1721.83 | A0611UHB | 1757.26 | 2108.71 |
| 1400+ | 1405-1450 | A0611UF | 1434.86 | 1721.83 | | | |
| 1600 | 1560-1605 | A0611VH | 1490.06 | 1788.07 | A0611VHB | 1922.57 | 2307.08 |
| 1600+ | 1605-1650 | A0611VF | 1490.06 | 1788.07 | | | |
| 1700 | 1660-1705 | A0611WH | 1536.63 | 1843.95 | A0611WHB | 1973.12 | 2367.74 |
| 1700+ | 1705-1750 | A0611WF | 1536.63 | 1843.95 | | | |

Please Note: Only + sizes are to be used with a Side Panel.

*Order Code for ordering shower enclosure with tray.

| Hinge and Inline sizes for use with Side Panel | | | | | Add a MERLYN MStone Tray | | |
|--|------------------------|------------|------------------|------------------|--------------------------|------------------|------------------|
| Size | Tray Finish Adjustment | Order Code | Price £ Exc. VAT | Price £ Inc. VAT | Order Code* | Price £ Exc. VAT | Price £ Inc. VAT |
| 900+ | 880-900 | A0611Y0 | 1054.83 | 1265.80 | A0611Y0B | 1235.73 | 1482.88 |
| 1000+ | 980-1000 | A0611RF | 1054.83 | 1265.80 | A0611RFB | 1259.15 | 1510.97 |
| 1100+ | 1080-1100 | A0611SF | 1127.00 | 1352.40 | A0611SFB | 1343.83 | 1612.60 |
| 1200+ | 1180-1200 | A0611TF | 1142.96 | 1371.55 | A0611TFB | 1357.67 | 1629.20 |
| 1400+ | 1380-1400 | A0611UF | 1434.86 | 1721.83 | A0611UFB | 1757.26 | 2108.71 |
| 1600+ | 1580-1600 | A0611VF | 1490.06 | 1788.07 | A0611VFB | 1922.57 | 2307.08 |
| 1700+ | 1680-1700 | A0611WF | 1536.63 | 1843.95 | A0611WFB | 1973.12 | 2367.74 |

*Order Code for ordering shower enclosure with tray.

| Optional Side Panel | | | | |
|---------------------|------------------------|------------|------------------|------------------|
| Size | Tray Finish Adjustment | Order Code | Price £ Exc. VAT | Price £ Inc. VAT |
| 760 | 740-760 | A0607B0 | 471.84 | 566.21 |
| 800 | 780-800 | A0607D0 | 471.84 | 566.21 |
| 900 | 880-900 | A0607E0 | 471.84 | 566.21 |

Please note: Moving panel door must close onto the Side Panel.

For wetroom installation, please reduce Side Panel Tray Finish Adjustment by 20mm.

8 | Series
frameless



Hinged Bifold Door / Shown in a Recess



Hinged Bifold Door / Shown with Side Panel



technical drawing.

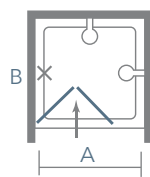

A: Door Opening
B: Width of panel when folded

| Size | A | B |
|------|-----|-----|
| 760 | 520 | 355 |
| 800 | 560 | 375 |
| 900 | 670 | 425 |
| 1000 | 780 | 475 |

Extension profiles available. See Page 99.

8^{MM}
GLASS
THICKNESS

LIFETIME
GUARANTEE

MERSHIELD
STAYCLEAR

Hinged Bifold Door

The 8 Series Frameless Bifold is an ingenious space saving solution for bathrooms with space restrictions, the hero of the bijou bathroom. Folding away neatly and horizontally flush to the wall, this screen allows you to double your feeling of space in any small bathroom giving you that extra elbow room you desire.

features.

- Height 1950mm
- Frameless
- Reversible
- Space solution
- Minimalist designer hinges

| Hinged Bifold Door | | | | | Add a MERLYN MStone Tray | | |
|--------------------|------------------------|------------|------------------|------------------|--------------------------|------------------|------------------|
| Size | Tray Finish Adjustment | Order Code | Price £ Exc. VAT | Price £ Inc. VAT | Order Code* | Price £ Exc. VAT | Price £ Inc. VAT |
| 760 | 720-750 | M87111 | 681.63 | 817.95 | M87111B | 789.78 | 947.73 |
| 800 | 760-790 | M87211 | 705.17 | 846.21 | M87211B | 825.99 | 991.18 |
| 900 | 860-890 | M87221 | 751.08 | 901.29 | M87221B | 923.02 | 1107.63 |
| 1000 | 960-990 | M87231 | 775.81 | 930.97 | M87231B | 970.69 | 1164.83 |

*Order Code for ordering shower enclosure and tray.
Please reduce the Tray Finish Adjustment by 5mm when using a Side Panel.

| Optional Side Panel | | | | |
|---------------------|------------------------|------------|------------------|------------------|
| Size | Tray Finish Adjustment | Order Code | Price £ Exc. VAT | Price £ Inc. VAT |
| 760 | 715-735 | M82101 | 449.71 | 539.65 |
| 800 | 755-775 | M82102 | 449.71 | 539.65 |
| 900 | 855-875 | M82103 | 476.79 | 572.15 |

For wetroom installation, reduce Side Panel Tray Finish Adjustment by 5mm.
Please note: Moving panel door must close onto the Side Panel.

8 | Series
frameless



1 Door Offset Quadrant / Shown with Left Hand TrueStone tray (L)

technical drawing.

1 Door Offset Quadrant

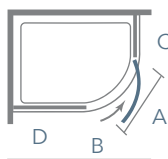

| Size | A | B | C | D |
|----------|-----|-----|-----|-----|
| 900x760 | 720 | 790 | 195 | 335 |
| 1000x800 | 720 | 790 | 235 | 435 |
| 1200x800 | 720 | 790 | 235 | 635 |
| 1200x900 | 720 | 790 | 335 | 635 |

A: Door Opening
 B: Door Swing
 C: Straight Panel
 B: Curved Panel

1 Door Quadrant

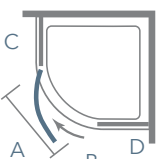

| Size | A | B | C | D |
|------|-----|-----|-----|-----|
| 800 | 720 | 790 | 235 | 235 |
| 900 | 720 | 790 | 335 | 335 |
| 1000 | 720 | 790 | 435 | 435 |

All sizes to suit a 550mm Radius Tray.
 Extension profiles available. See Page 99.

8^{MM}
GLASS
THICKNESS

LIFETIME
GUARANTEE

MERSHIELD
STAYCLEAR

1 Door Quadrants

The stylish 8 Series Frameless Offset Quadrant comes in a range of sizes, providing a spacious showering space that would suit any type of bathroom, traditional or contemporary.

features.

- Height 2000mm
- Large horizontal designer handle
- Secure "Clunk" closing
- Ultra slim hinges
- Concealed fixings
- Reversible
- Wetroom compatible

| 1 Door Offset Quadrant | | | | | Add a MERLYN MStone Tray | | |
|------------------------|------------------------|------------|------------------|------------------|--------------------------|------------------|------------------|
| Size | Tray Finish Adjustment | Order Code | Price £ Exc. VAT | Price £ Inc. VAT | Order Code* | Price £ Exc. VAT | Price £ Inc. VAT |
| 900x760 | 880-900 740-760 | A0601CH | 1449.00 | 1738.80 | A0601CHB L or R | 1693.43 | 2032.12 |
| 1000x800 | 980-1000 780-800 | A0601EH | 1460.48 | 1752.58 | A0601EHB L or R | 1693.43 | 2032.12 |
| 1200x800 | 1180-1200 780-800 | A0601HH | 1508.36 | 1810.03 | A0601HHB L or R | 1757.92 | 2109.51 |
| 1200x900 | 1180-1200 880-900 | A0601IH | 1508.36 | 1810.03 | A0601IHB L or R | 1766.03 | 2119.24 |

*Order Code for ordering shower enclosure and tray.

Tray for this product is handed. Select L for Left or R for Right when choosing.

| 1 Door Quadrant | | | | | Add a MERLYN MStone Tray | | |
|-----------------|------------------------|------------|------------------|------------------|--------------------------|------------------|------------------|
| Size | Tray Finish Adjustment | Order Code | Price £ Exc. VAT | Price £ Inc. VAT | Order Code* | Price £ Exc. VAT | Price £ Inc. VAT |
| 800 | 780-800 | A0601TH | 1215.68 | 1458.81 | A0601THB | 1380.95 | 1657.14 |
| 900 | 880-900 | A0601UH | 1215.68 | 1458.81 | A0601UHB | 1396.57 | 1675.89 |
| 1000 | 980-1000 | A0602ZH | 1313.80 | 1576.56 | A0602ZHB | 1549.83 | 1859.80 |

*Order Code for ordering shower enclosure and tray.



1 Door Quadrant

8 | Series
frameless





8 | series

If you are looking for a large selection of shapes to choose from, then 8 Series is the range for you. This range is a true style statement, with ingenious functionality. An excellent choice for all homeowners.

Why choose 8 Series?

8mm covered

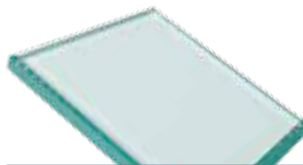

The 8mm glass in the 8 Series range is that great balance between our 10mm range and 6mm ranges. The glass is also toughened and tested rigorously to ensure maximum safety.

Easy clean double rollers

This feature on our 8 Series range is a great addition to make your enclosure the easiest to clean on the market. Simply push and release for easy cleaning in those hard to reach areas.



Every space covered

Not every space is the same, so MERLYN have designed a range of Inline Panels which can be added to standard enclosures to fit any width from 650mm to 1900mm. These ingenious semi-frameless panels, with a generous glass height of 1950mm, gives you options for almost any width you need.

Ergonomic handle

The elegantly designed internal and external handles are designed to effortlessly close the shower to a solid "Clunk" each time you shower. With a beautiful solid chrome plated finish, it adds a designer touch to your enclosure.



Tested for quality & safety

All products are rigorously tested by us and by global health and safety experts to make sure they adhere to the highest quality standards (CE mark info page 101).





Sliding Door / Shown with Side Panel

Sliding Door / Shown in a Recess

technical drawing.

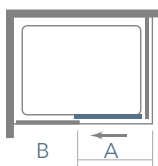

A: Door Opening
B: Fixed Panel

Extension profiles available. See Page 99.

| Size | A | B |
|------|-----|-----|
| 1000 | 390 | 440 |
| 1100 | 430 | 480 |
| 1200 | 470 | 530 |
| 1300 | 530 | 580 |
| 1400 | 570 | 630 |
| 1500 | 570 | 730 |
| 1600 | 570 | 830 |
| 1700 | 570 | 930 |



8
MM
GLASS
THICKNESS

LIFETIME
GUARANTEE

MERSHIELD
STAYCLEAR

Sliding Door

The 8 Series Sliding door is an impressive and highly engineered spacious enclosure with 8mm toughened safety glass, 1950mm high and smooth gliding action based on quick release double rollers for easy cleaning.

features.

- Height 1950mm
- Translucent seals
- Concealed fixings
- Full length chrome magnetic strips
- Easy clean double rollers
- Chrome handle
- Reversible
- Wetroom compatible

| Sliding Door | | | | | Add a MERLYN MStone Tray | | |
|--------------|------------------------|------------|------------------|------------------|--------------------------|------------------|------------------|
| Size | Tray Finish Adjustment | Order Code | Price £ Exc. VAT | Price £ Inc. VAT | Order Code* | Price £ Exc. VAT | Price £ Inc. VAT |
| 1000 | 950-990 | M88231 | 761.95 | 914.34 | MS88231 | 966.27 | 1159.52 |
| 1100 | 1050-1090 | M88251 | 761.95 | 914.34 | MS88251 | 979.28 | 1175.14 |
| 1200 | 1150-1190 | M88241 | 761.95 | 914.34 | MS88241 | 994.90 | 1193.88 |
| **1300 | 1250-1290 | M88240 | 926.23 | 1111.47 | MS88240** | 1209.25 | 1415.10 |
| 1400 | 1350-1390 | M88291 | 963.25 | 1155.89 | MS88291 | 1285.65 | 1542.78 |
| 1500 | 1450-1490 | M88261 | 996.70 | 1196.04 | MS88261 | 1364.22 | 1637.06 |
| 1600 | 1550-1590 | M88271 | 1008.99 | 1210.79 | MS88271 | 1441.50 | 1729.80 |
| 1700 | 1650-1690 | M88281 | 1058.14 | 1269.77 | MS88281 | 1494.65 | 1793.58 |

*Order code for ordering shower enclosure and tray.

**Available with Touchstone Tray only.

Please add 20mm to Tray Finish Adjustment when using a Side Panel.

Please state tray size required when ordering. For full information on our MStone trays see page 94.

Optional Side Panel

| Size | Tray Finish Adjustment | Order Code | Price £ Exc. VAT | Price £ Inc. VAT |
|------|------------------------|------------|------------------|------------------|
| 700 | 670-690 | M82201 | 425.52 | 510.63 |
| 760 | 730-750 | M82210 | 425.52 | 510.63 |
| 800 | 770-790 | M82211 | 425.52 | 510.63 |
| 900 | 870-890 | M82221 | 451.15 | 541.38 |
| 1000 | 970-990 | M82231 | 494.60 | 593.51 |

Sliding door can be paired with 2 optional Side Panels

For wetroom installation, please reduce Side Panel Tray Finish Adjustment by 20mm.

Optional Inline Panel

| Size | Tray Finish Adjustment | Order Code | Price £ Exc. VAT | Price £ Inc. VAT |
|------|------------------------|------------|------------------|------------------|
| 150 | 130-150 | M8P140 | 255.98 | 307.17 |
| 210 | 190-210 | M8P2200 | 268.04 | 321.64 |

Inline panels can be fitted to either or both sides of Sliding Door - See page 103 for space solutions.



Hinge Door / Shown in a Recess



Hinge Door / Shown with Side Panel

technical drawing.



A: Door Opening
B: Door Swing

| Size | A | B |
|------|-----|-----|
| 700 | 550 | 550 |
| 760 | 610 | 610 |
| 800 | 650 | 650 |
| 900 | 750 | 750 |
| 1000 | 850 | 850 |

Extension profiles available. See Page 99.

8^{MM}
GLASS
THICKNESS

LIFETIME
GUARANTEE

MERSHIELD
STAYCLEAR

Hinge Door

A practical choice for larger en suites or smaller bathrooms. The Hinge Door offers a highly specified and versatile option, making it suitable for a large range of spaces.

features.

- Height 1950mm
- Concealed fixings
- Extended length chrome design symmetry handle
- Translucent seals
- Wetroom compatible
- Minimalist exposed glass edge
- Signature hinges with internal flush fixings
- Reversible
- Double bales catch closing with definitive "Clunk" close

| Hinge Door | | | | | Add a MERLYN MStone Tray | | |
|------------|------------------------|------------|------------------|------------------|--------------------------|------------------|------------------|
| Size | Tray Finish Adjustment | Order Code | Price £ Exc. VAT | Price £ Inc. VAT | Order Code* | Price £ Exc. VAT | Price £ Inc. VAT |
| 700 | 650-690 | M81201 | 696.06 | 835.28 | - | - | - |
| 760 | 710-750 | M81210 | 697.46 | 836.96 | MS81210 | 813.28 | 975.94 |
| 800 | 750-790 | M81211 | 697.46 | 836.96 | MS81211 | 826.30 | 991.56 |
| 900 | 850-890 | M81221 | 772.14 | 926.57 | MS81221 | 953.04 | 1143.65 |
| 1000 | 950-990 | M81231 | 817.48 | 980.98 | MS81231 | 1021.80 | 1226.16 |

*Order code for ordering shower enclosure and tray.
Please add 20mm to Tray Finish Adjustment when using a Side Panel.

| Optional Side Panel | | | | |
|---------------------|------------------------|------------|------------------|------------------|
| Size | Tray Finish Adjustment | Order Code | Price £ Exc. VAT | Price £ Inc. VAT |
| 700 | 670-690 | M82201 | 425.52 | 510.63 |
| 760 | 730-750 | M82210 | 425.52 | 510.63 |
| 800 | 770-790 | M82211 | 425.52 | 510.63 |
| 900 | 870-890 | M82221 | 451.15 | 541.38 |
| 1000 | 970-990 | M82231 | 494.60 | 593.51 |

For wetroom installation, please reduce Side Panel Tray Finish Adjustment by 20mm.

| Optional Inline Panel | | | | |
|-----------------------|------------------------|------------|------------------|------------------|
| Size | Tray Finish Adjustment | Order Code | Price £ Exc. VAT | Price £ Inc. VAT |
| 150 | 130-150 | M8P140 | 255.98 | 307.17 |
| 210 | 190-210 | M8P2200 | 268.04 | 321.64 |

Inline panels can be fitted to either or both sides of Hinge Door - See page 103 for space solutions.
Please Note: Moving panel door must close onto the Side Panel.



Infold Door / Shown with Side Panel



Infold Door and Inline Panel / Shown in a Recess

technical drawing.



A: Door Opening
B: Door Swing

| Size | A | B |
|------|-----|-----|
| 700 | 505 | 200 |
| 760 | 565 | 260 |
| 800 | 605 | 300 |
| 900 | 705 | 400 |
| 1000 | 805 | 500 |

Extension profiles available. See Page 99.

8^{MM}
GLASS
THICKNESS

LIFETIME
GUARANTEE

MERSHIELD
STAYCLEAR

Infold Door

This door is the epitome of space saving solutions without compromising on the beautiful lines of the glass door. Pair this 1950mm high 8 Series door with the minimalist optional Side Panel and this enclosure becomes ideal for any corner setting.

features.

- Height 1950mm
- Concealed fixings
- Chrome design symmetry handle
- Reversible
- Wetroom compatible
- Translucent seals

| Infold Door | | | | | Add a MERLYN MStone Tray | | |
|-------------|------------------------|------------|------------------|------------------|--------------------------|------------------|------------------|
| Size | Tray Finish Adjustment | Order Code | Price £ Exc. VAT | Price £ Inc. VAT | Order Code* | Price £ Exc. VAT | Price £ Inc. VAT |
| 700 | 650-690 | M84401 | 737.38 | 884.85 | - | - | - |
| 760 | 710-750 | M84410 | 749.68 | 899.61 | MS84410 | 865.49 | 1038.59 |
| 800 | 750-790 | M84411 | 764.41 | 917.30 | MS84411 | 893.25 | 1071.90 |
| 900 | 850-890 | M84421 | 775.34 | 930.41 | MS84421 | 956.24 | 1147.49 |
| 1000 | 950-990 | M84431 | 843.95 | 1012.74 | MS84431 | 1048.27 | 1257.92 |

*Order code for ordering shower enclosure and tray.
Please add 20mm to Tray Finish Adjustment when using a Side Panel.

Optional Side Panel

| Size | Tray Finish Adjustment | Order Code | Price £ Exc. VAT | Price £ Inc. VAT |
|------|------------------------|------------|------------------|------------------|
| 700 | 670-690 | M82201 | 425.52 | 510.63 |
| 760 | 730-750 | M82210 | 425.52 | 510.63 |
| 800 | 770-790 | M82211 | 425.52 | 510.63 |
| 900 | 870-890 | M82221 | 451.15 | 541.38 |
| 1000 | 970-990 | M82231 | 494.60 | 593.51 |

For wetroom installation, please reduce Side Panel Tray Finish Adjustment by 20mm.

Optional Inline Panel

| Size | Tray Finish Adjustment | Order Code | Price £ Exc. VAT | Price £ Inc. VAT |
|------|------------------------|------------|------------------|------------------|
| 150 | 130-150 | M8P140 | 255.98 | 307.17 |
| 210 | 190-210 | M8P2200 | 268.04 | 321.64 |

Inline Panels can be fitted to either or both sides of Infold Door - See page 103 for space solutions.



Infold Door / Shown with Side Panel Overhead



1 Door Offset Quadrant / Shown on Right Hand (R) 1400x800 size available

technical drawing.

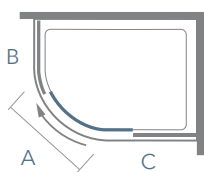

A: Door Opening
B: Fixed Panel
C: Straight Panel

1 Door Offset Quadrant

| Size | A | B | C |
|----------|-----|-----|-----|
| 900x760 | 420 | 465 | 275 |
| 1000x800 | 425 | 520 | 375 |
| 1200x800 | 425 | 520 | 575 |
| 1200x900 | 480 | 540 | 575 |
| 1400x800 | 425 | 520 | 775 |

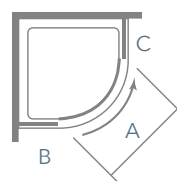

1 Door Quadrant

| Size | A | B | C |
|---------|-----|-----|-----|
| 900x900 | 480 | 540 | 275 |

All sizes to suit a 550mm Radius Tray.
Extension Profiles available. See Page 99.

8^{MM}
GLASS
THICKNESS

LIFETIME
GUARANTEE

MERSHIELD
STAYCLEAR

1 Door Quadrants

With fresh curved lines and designer chrome handles, the 1 Door Offset Quadrant exudes traditional style with a contemporary twist and a strong focus on expert engineering.

features.

- Height 1950mm
- Concealed fixings
- Chrome design symmetry handle
- Reversible
- Wetroom compatible
- Translucent seals

| 1 Door Offset Quadrant | | | | | Add a MERLYN MStone Tray | | |
|------------------------|------------------------|------------|------------------|------------------|--------------------------|------------------|------------------|
| Size | Tray Finish Adjustment | Order Code | Price £ Exc. VAT | Price £ Inc. VAT | Order Code* | Price £ Exc. VAT | Price £ Inc. VAT |
| 900x760 | 875-895 735-755 | M83222 | 1099.00 | 1318.80 | MS83222 L or R | 1370.43 | 1644.52 |
| 1000x800 | 975-995 775-795 | M83233 | 1099.00 | 1318.80 | MS83233 L or R | 1297.76 | 1557.31 |
| 1200x800 | 1175-1195 775-795 | M83243 | 1108.58 | 1330.30 | MS83243 L or R | 1314.50 | 1577.40 |
| 1200x900 | 1175-1195 875-895 | M83241 | 1108.58 | 1330.30 | MS83241 L or R | 1366.25 | 1639.50 |
| 1400x800 | 1375-1395 775-795 | M83244 | 1111.83 | 1334.20 | MS83244 L or R | 1397.95 | 1677.54 |

*Order code for ordering shower enclosure and tray.

Tray for this product is handed. Select L for Left or R for Right when choosing.

| MERLYN Dedicated Offset Quadrant Tray (1400x800) | | | |
|--|-----------------|------------------|------------------|
| Size | Order Code | Price £ Exc. VAT | Price £ Inc. VAT |
| 1400x800 | S148Q L or R | 286.11 | 343.34 |

This tray is handed please choose L for left and R for right when ordering.
Please Note: The 1400x800mm tray is not an MStone Tray, it is a dedicated single skinned tray.
For wetroom installation, please reduce Tray Finish Adjustment by 20mm.

| 1 Door Quadrant | | | | | Add a MERLYN MStone Tray | | |
|-----------------|------------------------|------------|------------------|------------------|--------------------------|------------------|------------------|
| Size | Tray Finish Adjustment | Order Code | Price £ Exc. VAT | Price £ Inc. VAT | Order Code* | Price £ Exc. VAT | Price £ Inc. VAT |
| 900 | 875-895 | M83225 | 970.29 | 1164.35 | MS83225 | 1151.19 | 1381.43 |

*Order code for ordering shower enclosure with tray.
For wetroom installation, please reduce Tray Finish Adjustment by 20mm.



2 Door Quadrant

technical drawing.

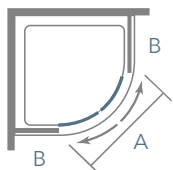

A: Door Opening
B: Fixed Panel

| Size | A | B |
|------|-----|-----|
| 800 | 410 | 220 |
| 900 | 540 | 320 |
| 1000 | 540 | 420 |

All sizes to suit a 550mm Radius Tray.
Extension profiles available. See Page 99.



8^{MM}
GLASS
THICKNESS

LIFETIME
GUARANTEE

MERSHIELD
STAYCLEAR

2 Door Quadrant

With fresh curved lines and designer chrome handles, the 2 Door Quadrant exudes traditional style with a contemporary twist and a strong focus on expert engineering.

features.

- Height 1950mm
- 8mm toughened glass
- Mershield Stayclear easy clean protected glass
- Lifetime Guarantee
- Translucent seals
- Concealed fixings
- Easy clean double rollers
- Chrome design symmetry handle
- Reversible
- Wetroom compatible

| 2 Door Quadrant | | | | | Add a MERLYN MStone Tray | | |
|-----------------|------------------------|------------|---------------------|---------------------|--------------------------|---------------------|---------------------|
| Size | Tray Finish Adjustment | Order Code | Price £ Exc. VAT | Price £ Inc. VAT | Order Code* | Price £ Exc. VAT | Price £ Inc. VAT |
| 800 | 775-795 | M83211 | 886.87 | 1064.25 | MS83211 | 1052.15 | 1262.58 |
| 900 | 875-895 | M83221 | 886.87 | 1064.25 | MS83221 | 1067.77 | 1281.32 |
| 1000 | 975-995 | M83231 | 1088.51 | 1306.22 | MS83231 | 1342.55 | 1589.46 |

*Order code for ordering shower enclosure with tray.
For wetroom installation, please reduce Tray Finish Adjustment by 20mm.



6^{MM}
GLASS
THICKNESS

LIFETIME
GUARANTEE

MERSHIELD
STAYCLEAR

6 | series | *frameless*

An elegant range of enclosures designed to offer a frameless look for any bathroom space. The beautifully crafted hinges and stabilising bars would suit both contemporary or traditionally styled bathrooms.

Why choose 6 Series frameless?

Discreet designer stabilising bar

This range offers a designer bracing bar that blends seamlessly into the glass, ensuring a secure and frameless feature within your bathroom.



Luxury solid metal handle

This range ensures minimalist elegance in every detail, including the luxury solid metal handle that comes as standard.



Fusion of elegance and functionality

This range offers a towering glass height of 2000mm while maintaining its luxurious frameless design.



Hinge and Inline / Shown with Side Panel

Stabilising Bar

technical drawing.

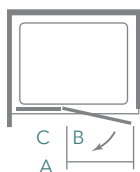

A: Door Opening
B: Door Swing
C: Fixed Panel

Extension profiles available. See Page 99.

| Size | A | B | C |
|-------|-----|-----|-----|
| 760 | 440 | 460 | 160 |
| 800 | 440 | 460 | 200 |
| 800+ | 480 | 500 | 200 |
| 900 | 490 | 510 | 250 |
| 900+ | 530 | 550 | 250 |
| 1000 | 540 | 560 | 300 |
| 1000+ | 580 | 600 | 350 |
| 1100 | 590 | 650 | 350 |

| Size | A | B | C |
|-------|-----|-----|-----|
| 1100+ | 630 | 610 | 350 |
| 1200 | 590 | 650 | 450 |
| 1200+ | 630 | 610 | 450 |
| 1400 | 590 | 650 | 650 |
| 1400+ | 630 | 610 | 650 |
| 1500 | 590 | 650 | 750 |
| 1500+ | 630 | 610 | 750 |

6^{MM}
GLASS
THICKNESS

LIFETIME
GUARANTEE

MERSHIELD
STAYCLEAR

Hinge and Inline

The new 6 Series Frameless Hinge & Inline Door is the perfect fusion between minimalist elegance and practical functionality. The luxuriously frameless design combined with the precision engineered chrome hinge, makes this a real statement piece.

features.

- Height 2000mm
- 8mm toughened glass
- 6mm moving panel
- Mershield Stayclear easy clean protected glass
- Luxury solid metal handle
- Sleek designer bracing bar
- Lifetime Guarantee
- Reversible

| Hinge & Inline in a Recess | | | | | Add a MERLYN MStone Tray | | |
|----------------------------|------------------------|--------------|------------------|------------------|--------------------------|------------------|------------------|
| Size | Tray Finish Adjustment | Order Code | Price £ Exc. VAT | Price £ Inc. VAT | Order Code* | Price £ Exc. VAT | Price £ Inc. VAT |
| 760 | 720-760 | S6F760REC | 588.03 | 705.63 | S6FB760REC | 703.84 | 844.61 |
| 800 | 760-800 | S6F800REC | 599.36 | 719.23 | S6FB800REC | 728.19 | 873.83 |
| 800+ | 800-840 | S6F800CORN | 599.36 | 719.23 | S6FB800CORN | 728.19 | 873.83 |
| 900 | 860-900 | S6F900REC | 622.02 | 746.42 | S6FB900REC | 802.91 | 963.49 |
| 900+ | 900-940 | S6F900CORN | 622.02 | 746.42 | S6FB900CORN | 802.91 | 963.49 |
| 1000 | 960-1000 | S6F1000REC | 667.34 | 800.80 | S6FB1000REC | 871.66 | 1045.99 |
| 1000+ | 1000-1040 | S6F1000CORN | 667.34 | 800.80 | S6FB1000CORN | 871.66 | 1045.99 |
| 1100 | 1060-1100 | S6F1100RECH | 701.33 | 841.59 | S6FB1100RECH | 930.37 | 1116.44 |
| 1100+ | 1100-1140 | S6F1100CORNH | 701.33 | 841.59 | S6FB1100CORNH | 930.37 | 1116.44 |
| 1200 | 1160-1200 | S6F1200RECH | 723.99 | 868.78 | S6FB1200RECH | 938.70 | 1126.44 |
| 1200+ | 1200-1240 | S6F1200CORNH | 723.99 | 868.78 | S6FB1200CORNH | 938.70 | 1126.44 |
| 1400 | 1360-1400 | S6F1400RECH | 769.31 | 923.17 | S6FB1400RECH | 1091.71 | 1310.05 |
| 1400+ | 1400-1440 | S6F1400CORNH | 769.31 | 923.17 | S6FB1400CORNH | 1091.71 | 1310.05 |
| 1500 | 1460-1500 | S6F1500RECH | 803.30 | 963.96 | S6FB1500RECH | 1170.81 | 1404.97 |
| 1500+ | 1500-1540 | S6F1500CORNH | 803.30 | 963.96 | S6FB1500CORNH | 1170.81 | 1404.97 |

| Hinge & Inline sizes for use with Side Panel | | | | | Add a MERLYN MStone Tray | | |
|--|------------------------|--------------|------------------|------------------|--------------------------|------------------|------------------|
| Size | Tray Finish Adjustment | Order Code | Price £ Exc. VAT | Price £ Inc. VAT | Order Code* | Price £ Exc. VAT | Price £ Inc. VAT |
| 800+ | 780-800 | S6F800CORN | 599.36 | 719.23 | S6FB800CORN | 728.19 | 873.83 |
| 900+ | 880-900 | S6F900CORN | 622.02 | 746.42 | S6FB900CORN | 802.91 | 963.49 |
| 1000+ | 980-1000 | S6F1000CORN | 667.34 | 800.80 | S6FB1000CORN | 871.66 | 1045.99 |
| 1100+ | 1080-1100 | S6F1100CORNH | 701.33 | 841.59 | S6FB1100CORNH | 930.37 | 1116.44 |
| 1200+ | 1180-1200 | S6F1200CORNH | 723.99 | 868.78 | S6FB1200CORNH | 938.70 | 1126.44 |
| 1400+ | 1380-1400 | S6F1400CORNH | 769.31 | 923.17 | S6FB1400CORNH | 1091.71 | 1310.05 |
| 1500+ | 1480-1500 | S6F1500CORNH | 803.30 | 963.96 | S6FB1500CORNH | 1170.81 | 1404.97 |

| Optional Side Panel to match + sizes only | | | | |
|---|------------------------|-------------|------------------|------------------|
| Size | Tray Finish Adjustment | Order Code* | Price £ Exc. VAT | Price £ Inc. VAT |
| 760 | 720-760 | S6F760SP | 297.98 | 357.57 |
| 800 | 760-800 | S6F800SP | 304.78 | 365.73 |
| 900 | 860-900 | S6F900SP | 327.44 | 392.92 |

For Wetroom installation please reduce min / max adjustment by 10mm.

6 | Series
frameless





6^{MM}
GLASS
THICKNESS

LIFETIME
GUARANTEE

MERSHIELD
STAYCLEAR

6 | series

The 6 Series range is the perfect choice if you are looking for a portfolio of shower enclosures to accommodate any space and design requirements.

Why choose 6 Series?

Easy clean double rollers

This feature on our 6 Series range makes your enclosure the easiest to clean on the market. Simply push and release for easy cleaning in those hard to reach areas.



A great range at a great price

The MERLYN 6 Series range offers all the benefits, design and technology of the Series Collection but at more accessible prices. This range delivers on style, function and value for money.

Chrome dual handle

A luxurious chrome dual handle complements the look of this framed range of enclosures with a discreet inside handle and larger external handle for easy closing.



Tested for quality & safety

All products are rigorously tested by us and by global health and safety experts to make sure they adhere to the highest quality standards (CE mark info page 101).

Every space covered

Not every space is the same, so MERLYN have designed a range of Inline Panels which can be added to standard enclosures to fit any width from 670mm to 1915mm. These ingenious semi-frameless panels, with a generous glass height of 1900mm, gives you options for almost any width you need.



Sliding Door / Shown with Side Panel

Sliding Door / Shown in a Recess

technical drawing.

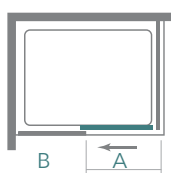

A: Door Opening
B: Fixed Panel

Extension profiles available. See Page 99.

| Size | A | B |
|------|-----|-----|
| 1000 | 380 | 420 |
| 1100 | 430 | 470 |
| 1200 | 480 | 520 |
| 1400 | 580 | 620 |
| 1500 | 580 | 720 |
| 1600 | 580 | 820 |
| 1700 | 580 | 920 |



6^{MM}
GLASS
THICKNESS

LIFETIME
GUARANTEE

MERSHIELD
STAYCLEAR

Sliding Door

The 6 Series Sliding Door has been enhanced with designer handles and quick release double rollers for easy access cleaning. With exceptionally smooth opening, this enclosure which stands at 1900mm high is affordable yet incredibly stylish.

features.

- Height 1900mm
- 6mm toughened glass
- Translucent seals
- Full length chrome magnetic strips
- Easy clean double rollers
- Double handed
- Can be used with 2 optional minimalist Side Panels
- Reversible
- Wetroom compatible

| Sliding Door | | | | | Add a MERLYN MStone Tray | | |
|--------------|------------------------|------------|------------------|------------------|--------------------------|------------------|------------------|
| Size | Tray Finish Adjustment | Order Code | Price £ Exc. VAT | Price £ Inc. VAT | Order Code* | Price £ Exc. VAT | Price £ Inc. VAT |
| 1000 | 950-1000 | M68231 | 543.49 | 652.19 | MS68231 | 747.81 | 897.37 |
| 1100 | 1050-1100 | M68251 | 543.49 | 652.19 | MS68251 | 760.82 | 912.98 |
| 1200 | 1150-1200 | M68241 | 543.49 | 652.19 | MS68241 | 758.20 | 909.84 |
| 1400 | 1350-1400 | M68291 | 667.10 | 800.52 | MS68291 | 989.50 | 1187.40 |
| 1500 | 1450-1500 | M68261 | 710.47 | 852.57 | MS68261 | 1077.99 | 1293.59 |
| 1600 | 1550-1600 | M68271 | 750.61 | 900.74 | MS68271 | 1183.11 | 1419.73 |
| 1700 | 1650-1700 | M68281 | 750.61 | 900.74 | MS68281 | 1261.75 | 1514.10 |

*Order code for ordering shower enclosure and tray.
Please add 20mm to Tray Finish Adjustment when using a Side Panel.

Optional Side Panel

| Size | Tray Finish Adjustment | Order Code | Price £ Exc. VAT | Price £ Inc. VAT |
|-----------|------------------------|------------|------------------|------------------|
| 700 | 680-705 | M62201N | 309.39 | 371.27 |
| 760 / 800 | 745-790 | M62211N | 278.45 | 334.14 |
| 900 | 875-900 | M62221N | 296.31 | 355.57 |
| 1000 | 975-1000 | M62231N | 328.44 | 394.12 |

Sliding door can be paired with 2 optional Side Panels

For wetroom installation, please reduce Side Panel Tray Finish Adjustment by 20mm.

Optional Inline Panel

| Size | Tray Finish Adjustment | Order Code | Price £ Exc. VAT | Price £ Inc. VAT |
|------|------------------------|------------|------------------|------------------|
| 140 | 115-140 | M6I125 | 242.72 | 291.26 |
| 215 | 190-215 | M6I200 | 254.91 | 305.90 |

Inline panels can be fitted to either or both sides of Sliding Door. See page 102 for space solutions.



Pivot Door / Shown with Side Panel

technical drawing.



A: Door Opening
B: Door Swing

| Size | A | B |
|---------|-----|-----|
| 700 | 410 | 410 |
| 760/800 | 480 | 480 |
| 900 | 590 | 590 |
| 1000 | 690 | 690 |

Note: Side Panel is 6mm glass
Extension profiles available. See Page 99.

8^{MM}
GLASS
THICKNESS

LIFETIME
GUARANTEE

MERSHIELD
STAYCLEAR

Pivot Door

At 1900mm high the 6 Series Pivot Door is a chic space saving solution. The 8mm toughened safety glass door pivots on elegant chrome mechanisms and with the addition of the minimalist glass edged side panel, it's perfect for any corner situation.

features.

- Height 1900mm
- Double bales catch closing with definitive "Clunk" close
- Solid metal minimalist pivots
- Translucent seals
- Easy clean double rollers
- Double handed
- Reversible
- Wetroom compatible

| Pivot Door | | | | | Add a MERLYN MStone Tray | | |
|------------|------------------------|------------|------------------|------------------|--------------------------|------------------|------------------|
| Size | Tray Finish Adjustment | Order Code | Price £ Exc. VAT | Price £ Inc. VAT | Order Code* | Price £ Exc. VAT | Price £ Inc. VAT |
| 700 | 670-720 | M61201 | 391.51 | 469.82 | - | - | - |
| 760/800 | 740-790 | M61211 | 440.79 | 528.95 | MS61211 | 556.60 | 667.92 |
| 900 | 850-900 | M61221 | 462.10 | 554.52 | MS61221 | 642.99 | 771.59 |
| 1000 | 950-1000 | M61231 | 487.09 | 584.50 | MS61231 | 691.42 | 829.70 |

*Order Code for ordering shower enclosure and tray.
Please add 10mm to Tray Finish Adjustment when using a Side Panel.

Optional Side Panel

| Size | Tray Finish Adjustment | Order Code | Price £ Exc. VAT | Price £ Inc. VAT |
|-----------|------------------------|------------|------------------|------------------|
| 700 | 680-705 | M62201 | 309.39 | 371.27 |
| 760 / 800 | 745-790 | M62211 | 278.45 | 334.14 |
| 900 | 875-900 | M62221 | 296.31 | 355.57 |
| 1000 | 975-1000 | M62231 | 328.44 | 394.12 |

For wetroom installation, please reduce Tray Finish Adjustment by 20mm.

Optional Inline Panel

| Size | Tray Finish Adjustment | Order Code | Price £ Exc. VAT | Price £ Inc. VAT |
|------|------------------------|------------|------------------|------------------|
| 140 | 115-140 | M61125 | 242.72 | 291.26 |
| 215 | 190-215 | M61200 | 254.91 | 305.90 |

Inline Panels can be fitted to either or both sides of Pivot Door. See page 102 for space solutions.



Bifold Door / Shown with Side Panel



Bifold Door / Shown in a Recess

technical drawing.

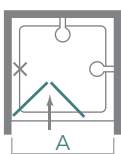

X: Do not put shower head here
A: Door Opening

| Size | A |
|---------|-----|
| 700 | 420 |
| 760/800 | 490 |
| 900 | 600 |
| 1000 | 650 |

Extension profiles available. See Page 99.

6^{MM}
GLASS
THICKNESS

LIFETIME
GUARANTEE

MERSHIELD
STAYCLEAR

Bifold Door

Where space is at a premium the 6 Series Bifold is the ultimate solution. This new version of a classic shape, offers a sleek frameless design with a discreet chrome hinge detail.

features.

- Height 1900mm
- Discreet chrome bifold hinge
- Sleek frameless door design
- Reversible
- Wetroom compatible

| Bifold Door | | | | | Add a MERLYN MStone Tray | | |
|-------------|------------------------|------------|------------------|------------------|--------------------------|------------------|------------------|
| Size | Tray Finish Adjustment | Order Code | Price £ Exc. VAT | Price £ Inc. VAT | Order Code* | Price £ Exc. VAT | Price £ Inc. VAT |
| 700 | 670-720 | M67201 N | 607.85 | 729.43 | - | - | - |
| 760/800 | 740-790 | M67211 N | 607.85 | 729.43 | M67211B | 723.67 | 868.40 |
| 900 | 850-900 | M67221 N | 651.53 | 781.83 | M67221B | 832.42 | 998.90 |
| 1000 | 950-1000 | M67231 N | 685.23 | 822.27 | M67231B | 889.55 | 1067.46 |

*Order Code for ordering shower enclosure and tray.
Can be used with 2 optional minimalist Side Panels.
Please add 10mm to Tray Finish Adjustment when using a Side Panel.

Optional Side Panel

| Size | Tray Finish Adjustment | Order Code | Price £ Exc. VAT | Price £ Inc. VAT |
|---------|------------------------|------------|------------------|------------------|
| 700 | 680-705 | M62201 | 309.39 | 371.27 |
| 760/800 | 745-790 | M62211 | 278.45 | 334.14 |
| 900 | 875-900 | M62221 | 296.31 | 355.57 |
| 1000 | 975-1000 | M62231 | 328.44 | 394.12 |

For wetroom installation, please reduce Side Panel Tray Finish Adjustment by 20mm.

Optional Inline Panel

| Size | Tray Finish Adjustment | Order Code | Price £ Exc. VAT | Price £ Inc. VAT |
|------|------------------------|------------|------------------|------------------|
| 140 | 115-140 | M6I125 | 242.72 | 291.26 |
| 215 | 190-215 | M6I200 | 254.91 | 305.90 |

Inline Panels can be fitted to either or both sides of Bifold Door. See page 102 for space solutions.



1 Door Quadrant



2 Door Quadrant

technical drawing.

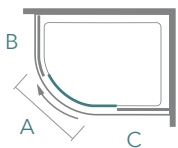

A: Door Panel
B: Curved Panel
C: Straight Panel

1 Door Quadrants

| Size | A | B | C |
|----------|-----|-----|-----|
| 900x760 | 405 | 460 | 280 |
| 900x900 | 480 | 540 | 250 |
| 1000x800 | 430 | 495 | 380 |
| 1200x800 | 430 | 495 | 580 |
| 1200x900 | 480 | 540 | 580 |

All sizes to suit a 550mm Radius Tray.
Extension profiles available. See Page 99.

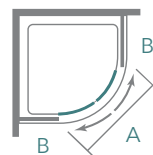

A: Door Opening
B: Fixed Panel

2 Door Quadrant

| Size | A | B |
|------|-----|-----|
| 800 | 375 | 225 |
| 900 | 540 | 325 |
| 1000 | 540 | 425 |

6^{MM}
GLASS
THICKNESS

LIFETIME
GUARANTEE

MERSHIELD
STAYCLEAR

Quadrants

The 6 Series Quadrants have it all - 1900mm high with a beautifully curved chrome frame, 6mm toughened glass, designer handles and quick release double rollers for easy access to clean - stylish yet very affordable.

features.

- Height 1900mm
- Translucent seals
- Easy clean double rollers
- Double handed
- Single sliding door
- Reversible
- Wetroom compatible

| 1 Door Quadrant | | | | | Add a MERLYN MStone Tray | | |
|-----------------|------------------------|------------|------------------|------------------|--------------------------|------------------|------------------|
| Size | Tray Finish Adjustment | Order Code | Price £ Exc. VAT | Price £ Inc. VAT | Order Code* | Price £ Exc. VAT | Price £ Inc. VAT |
| 900 | 875-900 | M63225 | 703.51 | 844.21 | MS63225 | 884.42 | 1061.30 |

| 1 Door Offset Quadrant | | | | | Add a MERLYN MStone Tray | | |
|------------------------|------------------------|------------|------------------|------------------|--------------------------|------------------|------------------|
| Size | Tray Finish Adjustment | Order Code | Price £ Exc. VAT | Price £ Inc. VAT | Order Code* | Price £ Exc. VAT | Price £ Inc. VAT |
| 900x760 | 875-900 735-760 | M63222 | 781.32 | 937.58 | MS63222 Lor R | 1027.28 | 1232.74 |
| 1000x800 | 975-1000 775-800 | M63233 | 928.42 | 1114.10 | MS63233 Lor R | 1161.37 | 1393.64 |
| 1200x800 | 1175-1200 775-800 | M63243 | 926.87 | 1112.24 | MS63243 Lor R | 1171.51 | 1405.81 |
| 1200x900 | 1175-1200 875-900 | M63241 | 928.40 | 1114.08 | MS63241 Lor R | 1186.09 | 1423.31 |

*Order code for ordering shower enclosure with tray.
For wetroom installation, please reduce Tray Finish Adjustment by 20mm.

Tray for this product is handed.
Select L for Left or R for Right when choosing.

| 2 Door Quadrant | | | | | Add a MERLYN MStone Tray | | |
|-----------------|------------------------|------------|------------------|------------------|--------------------------|------------------|------------------|
| Size | Tray Finish Adjustment | Order Code | Price £ Exc. VAT | Price £ Inc. VAT | Order Code* | Price £ Exc. VAT | Price £ Inc. VAT |
| 800 | 775-800 | M63211 | 594.91 | 713.89 | MS63211 | 760.18 | 912.22 |
| 900 | 875-900 | M63221 | 594.91 | 713.89 | MS63221 | 775.81 | 930.97 |
| 1000 | 975-1000 | M63231 | 748.37 | 898.04 | MS63231 | 984.40 | 1181.28 |

*Order code for ordering shower enclosure with tray.
For wetroom installation, please reduce Side Panel Tray Finish Adjustment by 20mm.



Corner Door

technical drawing.

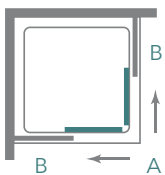

A: Door Opening
B: Fixed Panel

| Size | A | B |
|------|-----|-----|
| 800 | 395 | 310 |
| 900 | 465 | 360 |

Extension profiles available. See Page 99.

6^{MM}
GLASS
THICKNESS

LIFETIME
GUARANTEE

MERSHIELD
STAYCLEAR

Corner Door

The 6 Series Corner door is a functional and contemporary enclosure. It is the perfect solution for bijou en suites or awkward spaces as the doors slide back within the confines of the shower itself.

features.

- Height 1900mm
- Translucent seals
- Easy clean double rollers
- Double handed
- Double sliding doors
- Reversible
- Wetroom compatible

| Corner Door | | | | | Add a MERLYN MStone Tray | | |
|-------------|------------------------|------------|------------------|------------------|--------------------------|------------------|------------------|
| Size | Tray Finish Adjustment | Order Code | Price £ Exc. VAT | Price £ Inc. VAT | Order Code* | Price £ Exc. VAT | Price £ Inc. VAT |
| 800 | 775-800 | M65211 | 681.94 | 818.33 | MS65211 | 810.78 | 972.94 |
| 900 | 875-900 | M65221 | 750.52 | 900.62 | MS65221 | 931.42 | 1117.70 |

*Order code for ordering shower enclosure with tray.
For wetroom installation, please reduce Tray Finish Adjustment by 20mm.





10_{MM}
GLASS
THICKNESS

8_{MM}
GLASS
THICKNESS

LIFETIME
GUARANTEE

MERSHIELD
STAYCLEAR

Wetrooms

MERLYN Wetrooms offer you the ultimate in versatility and luxury. Whether you are after the New York style loft appeal or you need to create a bathroom with inclusive design, then Showerwalls and Wetrooms are the solution for you.

Why choose MERLYN Wetrooms?

Choice of glass

Available in 10mm and 8mm glass and up to a height of 2015mm, the MERLYN Wetrooms offer you choice to suit our space.

A showerwall even for small spaces

The MERLYN Single and Double Folding Showerwall are the solution to create a wetroom finish within bathrooms that have space restrictions. MERLYN offer you a solution for every space.

A solution for every situation

The MERLYN Wetrooms provide several additional options to complement your showerwall for whatever you need to achieve within your bathroom.



Wetrooms 10|series



10 Series Showerwall / with Wall Profile only



Showerwall / with Swivel Panel (E)



Showerwall / with Cube Panel (F)



Showerwall / with Vertical Post (G)

10
MM
GLASS
THICKNESS

LIFETIME
GUARANTEE

MERSHIELD
STAYCLEAR

Wetrooms

Luxurious Wetroom Panels, crafted with our signature 10mm glass. Each showerwall comes with a wall profile you can tailor with various options such as; stabilising bars, end, swivel or cube panels and flush wall and floor profiles. Pick and choose from the 9 additional options to give your wetroom the luxurious finish.

features.

- Height 2000mm
- 10mm toughened glass
- Mershield Stayclear easy clean protected glass
- Choice of additional options to tailor your wetroom to suit your space
- Suitable for a recess or corner situation
- Suitable for wetroom and shower tray application
- Reversible
- Lifetime Guarantee

| 10 Series Showerwall (including Wall Profile only) | | | | | | Showerwall with Straight Stabilising Bar (including Wall Profile) | | | |
|--|------------------------|------------|------------|-----------------|------------------|---|-------------|------------------|------------------|
| Size | Tray Finish Adjustment | Glass Type | Order Code | Price £ Exc.VAT | Price £ Inc. VAT | Addi- tional Option | Order Code* | Price £ Exc. VAT | Price £ Inc. VAT |
| 300** | 275-290 | Clear | S10SW300 | 317.20 | 380.64 | A | S10SW300H | 488.07 | 585.69 |
| 400** | 375-390 | Clear | S10SW400 | 325.90 | 391.09 | A | S10SW400H | 496.77 | 596.13 |
| 500** | 475-490 | Clear | S10SW500 | 387.69 | 465.23 | A | S10SW500H | 558.56 | 670.28 |
| 600** | 575-590 | Clear | S10SW600 | 434.94 | 521.93 | A | S10SW600H | 605.81 | 726.98 |
| 700** | 675-690 | Clear | S10SW700 | 459.17 | 551.00 | A | S10SW700H | 630.04 | 756.05 |
| 800** | 775-790 | Clear | S10SW800 | 483.40 | 580.08 | A | S10SW800H | 654.27 | 785.13 |
| 900** | 875-890 | Clear | S10SW900 | 507.63 | 609.16 | A | S10SW900H | 678.51 | 814.21 |
| 1000 | 975-990 | Clear | S10SW1000 | 519.75 | 623.70 | A | S10SW1000H | 690.62 | 828.74 |
| 1100 | 1075-1090 | Clear | S10SW1100 | 556.10 | 667.32 | A | S10SW1100H | 726.97 | 872.36 |
| 1200 | 1175-1190 | Clear | S10SW1200 | 592.44 | 710.92 | A | S10SW1200H | 763.31 | 915.98 |
| 1400 | 1375-1390 | Clear | S10SW1400 | 653.02 | 783.62 | A | S10SW1400H | 823.89 | 988.67 |

*Order code for ordering shower enclosure with tray.

**Please Note: These sizes are the only sizes we recommend for use as end panels. We recommend a minimum opening space of 500mm.

Additional Options

| | Size mm | Order Code** | Price £ Exc. VAT | Price £ Inc. VAT |
|---|--------------|--------------|------------------|------------------|
| A) Angled Stabilising Bar | 350 | SP08SCU12320 | 95.25 | 114.31 |
| B) Straight Stabilising Bar* | max 1 metre | SP0S8TRSET N | 170.54 | 204.65 |
| C) Vertical Ceiling Bracing Bar*** NEW | 400 | CBB440 | 134.00 | 160.80 |
| D) T Bracket (to connect 2 stabilising bars) | N/A | SP0S8RTPSET | 44.01 | 52.81 |
| E) Swivel Panel 8mm glass | 300 | M8SWS30 N | 262.77 | 315.32 |
| F) Cube Panel 8mm glass** | 300 | A0413F0 N | 156.29 | 187.55 |
| G) Vertical Post | max 3 metres | A0417C0 N | 153.34 | 184.01 |
| H) U channel | max 1400 | MGVC35A | 29.49 | 35.39 |
| I) Glass to glass profile | 2000 | A04S003 | 45.43 | 54.51 |

*Please Note: We recommend the use of a stabilising bar for any Showerwall over 900mm.

**Cube Panel must be fitted on a flat tray/wetroom situation.

***Please note: Max height of ceiling bar from top of glass is 400mm.

Additional Options

- J) Flush Wall Profile
- K) Flush Floor Profile

*Please Note: These are available as bespoke options. Please contact Customer Services for sizes and prices.

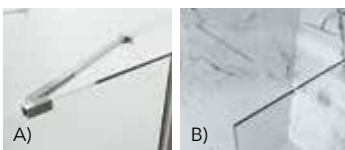

Wetrooms 8|series



Showerwall / with Swivel Panel (C)



Showerwall / with Cube Panel (D)



Showerwall / with Vertical Post (E)



8 Series Showerwall / with Wall Profile only

Corner Profile



Showerwall

The 8 Series Showerwalls are stylish yet functional by design. With frameless 8mm toughened safety glass, these panels stand at an impressive 2015mm high, including rail and are suitable for a recess or a corner situation. They are guaranteed to make a statement in any bathroom.

features.

- Height 2015mm including rail
- Suitable for wetroom and shower tray application
- 1M Stabilising bar comes as standard with all sizes
- Suitable for recess or corner situation
- Reversible

| Showerwall | | | | | Add a MERLYN MStone Tray | | | |
|------------|------------------------|------------|------------------|------------------|--------------------------|-------------|------------------|------------------|
| Size | Tray Finish Adjustment | Order Code | Price £ Exc. VAT | Price £ Inc. VAT | Tray Size | Order Code* | Price £ Exc. VAT | Price £ Inc. VAT |
| 700 | 670-690 | M8SW201 | 556.39 | 667.66 | 1200x900 | MS8SW201 | 789.34 | 947.21 |
| 800 | 770-790 | M8SW211 | 577.30 | 692.77 | 1400x900 | MS8SW211 | 899.70 | 1079.64 |
| 900 | 870-890 | M8SW221 | 604.38 | 725.26 | 1400x900 | MS8SW221 | 940.05 | 1128.06 |
| 1000 | 970-990 | M8SW231 | 611.78 | 734.13 | 1500x900 | MS8SW231 | 979.29 | 1175.15 |
| 1200 | 1170-1190 | M8SW241 | 645.01 | 774.01 | 1680x760 | MS8SW241 | 1081.51 | 1297.81 |

*Order code for ordering shower enclosure with tray. Please state the tray size required when order. For full information on our MStone trays see page 94. 1000mm stabilising bar comes as standard with all products.

| Additional Options | | | | |
|---|--------------|--------------|------------------|------------------|
| | Size mm | Order Code** | Price £ Exc. VAT | Price £ Inc. VAT |
| A) Angled Stabilising Bar | 350 | SP08SCU12320 | 95.25 | 114.31 |
| B) Extended Stabilising Bar* NEW | max 1500 | A0S0105 | 219.00 | 262.80 |
| C) Swivel Panel | 300 | M8SWS30 N | 262.77 | 315.32 |
| D) Cube Panel 8mm glass** | 300 | A0413F0 N | 156.29 | 187.55 |
| E) Vertical Post | max 3 metres | A0417C0 N | 153.34 | 184.01 |
| F) Corner profile-Glass to glass profile | 2000 | A04S003 | 45.43 | 54.51 |
| G) Vertical Ceiling Bracing Bar*** NEW | 400 | CBB440 | 134.00 | 160.80 |

*Please Note: We recommend the use of a stabilising bar for any Showerwall over 900mm.

**Cube Panel must be fitted on a flat tray/wetroom situation.

***Please note: Max height of ceiling bar from top of glass is 400mm.

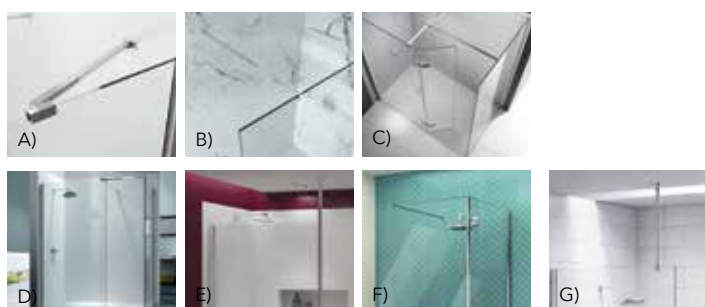

Wetrooms 8|series



8^{MM}
GLASS
THICKNESS

LIFETIME
GUARANTEE

MERSHIELD
STAYCLEAR

Pivot Showerwall / Single



8^{MM}
GLASS
THICKNESS

LIFETIME
GUARANTEE

MERSHIELD
STAYCLEAR

Pivot Showerwall / Double

Pivot Showerwall

- *Single and Double*

The 8 Series Pivot Showerwall offers you the choice of a single wetroom panel, perfect for tight spaces, or a double wetroom panel which creates an enclosed corner situation. Choices to create the space you desire.

features.

- Height 1950mm
- Solid chrome double handle
- Cover caps
- Space saving solution
- Inward and outward opening swing
- Concealed fixings
- Reversible
- Wetroom compatible

| Pivot Showerwall / Single | | | | |
|---------------------------|------------|------------|---------------------|---------------------|
| Size | Adjustment | Order Code | Price £ Exc. VAT | Price £ Inc. VAT |
| 760 | 690-710 | S8FPV76 | 529.00 | 634.80 |
| 800 | 730-750 | S8FPV80 | 549.00 | 658.80 |
| 900 | 830-850 | S8FPV90 | 579.00 | 694.80 |
| 1000 | 930-950 | S8FPV100 | 599.00 | 718.80 |

Please Note: We recommend fitting this product in a Wetroom situation only.

| Pivot Showerwall / Double | | | | |
|---------------------------|------------|------------|---------------------|---------------------|
| Size | Adjustment | Order Code | Price £ Exc. VAT | Price £ Inc. VAT |
| 760x760 | 690-710 | S8FPC76H | 1097.00 | 1316.40 |
| 800x800 | 730-750 | S8FPC80H | 1137.00 | 1364.40 |
| 900x900 | 830-850 | S8FPC90H | 1197.00 | 1436.40 |
| 1000x1000 | 930-950 | S8FPC100H | 1237.00 | 1484.40 |

Please Note: We recommend fitting this product in a Wetroom situation only.



Curved Showerwall

Showerwall / Overhead shot

8^{MM}
GLASS
THICKNESS

LIFETIME
GUARANTEE

MERSHIELD
STAYCLEAR

Curved Showerwall

The beautiful curved glass of the new 8 Series Curved Showerwall follows the contour of your offset quadrant tray, giving a softer finish. The extra length of the curved panel also deflects water spray inwards. This frameless design boasts Mershield Stayclear, ensuring peace of mind with the MERLYN Lifetime Guarantee.

features.

- Height 2015mm including rail
- Minimalist frameless design
- Reversible
- Suitable for wetroom and shower tray application
- Can be used with 800mm and 900mm trays

| Curved Showerwall | | | | | Add a MERLYN MStone Tray | | | |
|-------------------|------------------------|-------------|------------------|------------------|--------------------------|------------------|------------------|------------------|
| Size | Tray Finish Adjustment | Order Code* | Price £ Exc. VAT | Price £ Inc. VAT | Tray Size | Order Code* | Price £ Exc. VAT | Price £ Inc. VAT |
| 900 | 885-900 | S8CURV900 | 750.87 | 901.04 | 900x900 | S8CURV900B | 994.47 | 1193.36 |
| 1000 | 985-1000 | S8CURV1000 | 792.07 | 950.48 | 1000x800 | S8CURV1000B LorR | 1022.78 | 1227.34 |
| 1200 | 1185-1200 | S8CURV1200 | 864.17 | 1037.00 | 1200x900 | S8CURV1200B LorR | 1106.46 | 1327.75 |

*Order code for ordering shower enclosure with tray.
Tray for this product is handed. Please choose L for Left Handed and R for Right Handed.

Curved Showerwall Foot

| Order Code | Price £ Exc. VAT | Price £ Inc. VAT |
|------------|------------------|------------------|
| S8CSSWLEG | 79.00 | 94.80 |

This foot allows for greater stability on rectangular trays and sloped wetroom floors.

technical drawing.

Wetroom application

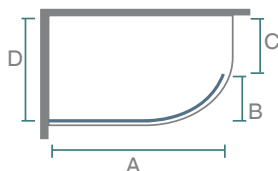

Tray application

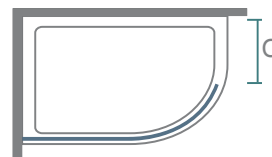

A = Panel length
B = Panel depth
C = Panel opening
D = Distance from the wall to the outside of the frame should be max 970mm.
This is to allow the stabilising bar to reach the wall.

| Panel Size | Tray Size | A | B | C |
|------------|------------|------|-----|-----|
| 900 | 900 x 900 | 810 | 275 | 600 |
| 1000 | 1000 x 800 | 910 | 275 | 500 |
| 1200 | 1200 x 800 | 1110 | 275 | 500 |
| | 1200 x 900 | 1110 | 275 | 600 |

We recommend a minimum opening of 500mm.



Showerwall with Hinged Swivel Panel

Walk in / with Hinged Swivel Panel overhead view

8^{MM}
GLASS
THICKNESS

LIFETIME
GUARANTEE

MERSHIELD
STAYCLEAR

Hinged Swivel Panel

The 8 Series Hinged Swivel Panel features 2 beautifully crafted designer hinges that give this door a stunning frameless and minimalist finish. The stylish yet understated model is flexible in terms of options and is available with or without an End Panel.

features.

- Height 2015mm including rail
- Minimalist frameless design
- Swivel Panel can be adjusted to deflect shower spray
- Suitable for wetroom and shower tray application
- Reversible

| Showerwall with Hinged Swivel Panel | | | | | | Add a MERLYN MStone Tray | | | |
|-------------------------------------|---------------------|----------------------|------------|-----------------|-----------------|--------------------------|-------------|-----------------|-----------------|
| Size | Front Panel Size mm | Swivel Panel Size mm | Order Code | Price £ Exc.VAT | Price £ Inc.VAT | Tray Size | Order Code* | Price £ Exc.VAT | Price £ Inc.VAT |
| 1050 | 700 | 350 | M8SW251 | 659.92 | 791.91 | 1200x900 | M8SW1100HB | 879.85 | 1055.82 |
| 1250 | 900 | 350 | M8SW261 | 697.23 | 836.67 | 1400x900 | M8SW1200HB | 1032.90 | 1239.48 |
| | | | | | | 1500x900 | M8SW1300HB | 1064.74 | 1277.69 |
| 1350 | 1000 | 350 | M8SW271 | 714.72 | 857.66 | 1500x900 | M8SW1400HB | 1082.23 | 1298.68 |
| | | | | | | 1600x900 | M8SW1500HB | 1147.22 | 1376.66 |

*Order code for ordering shower enclosure with tray
Please Note: We recommend a minimum opening space of 500mm.

| Walk In with Hinged Swivel Panel | | | | | | Add a MERLYN MStone Tray | | | |
|----------------------------------|--|------------|------------|-----------------|-----------------|--------------------------|-------------|-----------------|-----------------|
| Area mm | Panel Size mm (Front+Swivel+End Panel) | Opening mm | Order Code | Price £ Exc.VAT | Price £ Inc.VAT | Tray Size | Order Code* | Price £ Exc.VAT | Price £ Inc.VAT |
| 1200x800 | 700+350+800 | 500 | M8SWS100H | 1237.23 | 1484.67 | 1200x800 | M8SW100HB | 1457.15 | 1748.58 |
| 1200x900 | 700+350+900 | 500 | M8SWS400H | 1264.29 | 1517.15 | 1200x900 | M8SW600HB | 1497.25 | 1796.70 |
| 1400x800 | 900+350+800 | 500 | M8SWS200H | 1274.53 | 1529.44 | 1400x800 | M8SW200HB | 1596.93 | 1916.32 |
| 1400x800 | 900+350+800 | 600 | | | | 1500x800 | M8SW300HB | 1642.05 | 1970.46 |
| 1400x900 | 900+350+900 | 500 | M8SWS500H | 1301.61 | 1561.93 | 1400x900 | M8SW700HB | 1637.28 | 1964.74 |
| 1500x900 | 900+350+900 | 600 | | | | 1500x900 | M8SW800HB | 1669.13 | 2002.96 |
| 1500x800 | 1000+350+800 | 500 | M8SWS300H | 1292.02 | 1550.43 | 1500x800 | M8SW400HB | 1659.54 | 1991.45 |
| 1600x800 | 1000+350+800 | 600 | | | | 1600x800 | M8SW500HB | 1724.53 | 2069.44 |
| 1500x900 | 1000+350+900 | 500 | M8SWS600H | 1319.00 | 1582.92 | 1500x900 | M8SW900HB | 1686.62 | 2023.94 |
| 1600x900 | 1000+350+900 | 600 | | | | 1600x900 | M8SW1000HB | 1751.61 | 2101.93 |

Please Note: We recommend a minimum opening space of 500mm.

Wetrooms 8|series



8^{MM}
GLASS
THICKNESS

LIFETIME
GUARANTEE

MERSHIELD
STAYCLEAR



8^{MM}
GLASS
THICKNESS

LIFETIME
GUARANTEE

MERSHIELD
STAYCLEAR

Folding Showerwall

- *Single and Double*

The 8 Series Folding Showerwall is an ingenious space saving solution for bathrooms with space restrictions. The hero of the bijou bathroom. Folding away neatly and horizontally flush to the wall, this screen allows you to double your feeling of space in any small bathroom giving you that space you desire.

features.

- Height 1950mm
- Minimalist frameless design
- Suitable for wetroom situation only
- Reversible
- Space solution
- Minimalist designer hinges

Folding Showerwall

| Size | Adjustment | Order Code | Price £ Exc. VAT | Price £ Inc. VAT |
|------|------------|------------|---------------------|---------------------|
| 760 | 680-700 | M87111 | 681.63 | 817.95 |
| 800 | 720-740 | M87211 | 705.17 | 846.21 |
| 900 | 820-840 | M87221 | 751.08 | 901.29 |
| 1000 | 920-940 | M87231 | 775.81 | 930.97 |

Please Note: We recommend fitting this product in a Wetroom situation only.

Double Folding Showerwall

| Size | Adjustment | Order Code | Price £ Exc. VAT | Price £ Inc. VAT |
|-----------|------------|------------|---------------------|---------------------|
| 760x760 | 715-735 | M86101H | 1323.55 | 1588.25 |
| 800x800 | 755-775 | M86102H | 1369.26 | 1643.12 |
| 900x900 | 855-875 | M86103H | 1458.41 | 1750.10 |
| 1000x1000 | 955-975 | M86104H | 1506.42 | 1807.70 |

Please Note: We recommend fitting this product in a Wetroom situation only.

SecureSeal.
by MERLYN



The ultimate leak free bath screens

SecureSeal by MERLYN offers functional and easy to use designs to complement any bathroom space. It has been designed with the same unrelenting attention to detail demonstrated across all MERLYN products.

Why choose SecureSeal?

Glass screen heights

With a screen height of 1500mm and glass of 6mm this bath screen offers you great quality together with it's functionality.



Tested for quality & safety

All products are rigorously tested by us and by global health and safety experts to make sure they adhere to the highest quality standards (CE mark info page 101).

Space solutions

With the option of a Single, 4 Fold or 5 Fold, the SecureSeal by MERLYN offers you choice to suit your bathroom space.

Leak Free Sealing Arm

The leak free sealing arm gives you peace of mind to enjoy a leak free shower experience.

Fixed panel storage option

All sizes within this range of bath screens offer you the choice of adding our Fixed Panel storage option, giving you greater storage and functionality.





This is the SecureSeal Leak Free Sealing Arm



SecureSeal Lock

How SecureSeal works

The SecureSeal by MERLYN has been designed with a *Leak Free Sealing Arm* which extends from the profile to create a complete seal between the bath and screen. When not in use, the arm simply folds away back into the profile.

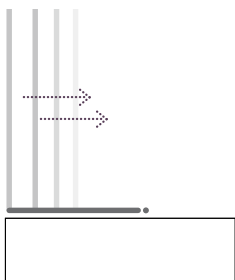

01. Extend

Extend screen and locate panels.

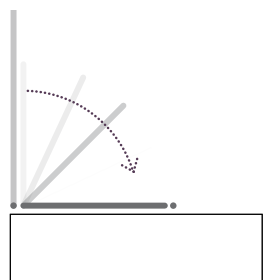

02. Pull Down

Pull down arm from storage position.

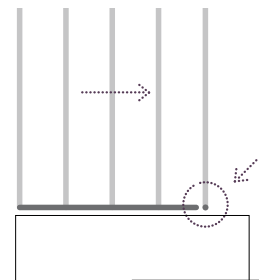

03. Lock In

Fully extend and clip into position for a secure fit and tight seal.



SecureSeal Single Panel

Single Panel

| Size | Adjustment | Order Code | Price £ Exc. VAT | Price £ Inc. VAT |
|----------|------------|------------|---------------------|---------------------|
| 800x1500 | 780-800 | MS1 | 230.01 | 276.01 |

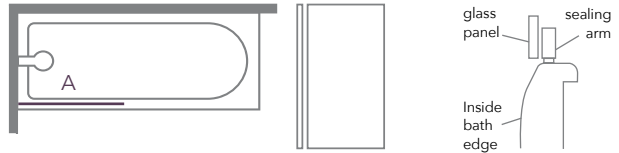

A: Moving Panels (screen width when folded into the bath 712mm)
 ○ Recommended shower head position



SecureSeal Single Panel - *with Storage*

Single Panel with storage

| Size | Adjustment | Order Code | Price £ Exc. VAT | Price £ Inc. VAT |
|----------|------------|------------|---------------------|---------------------|
| 800x1500 | 780-800 | MS1 | 230.01 | 276.01 |

Optional SecureSeal Fixed Panel

| Size | Adjustment | Order Code | Price £ Exc. VAT | Price £ Inc. VAT |
|----------|------------|------------|---------------------|---------------------|
| 300x1500 | 300-320 | MSFP | 181.94 | 218.33 |



A: Moving Panels (screen width when folded into the bath 712mm) B: Fixed Panel
 ○ Recommended shower head position



SecureSeal 4 Fold

4 Fold

| Size | Adjustment | Order Code | Price £ Exc. VAT | Price £ Inc. VAT |
|----------|------------|------------|---------------------|---------------------|
| 800x1500 | 780-800 | MS4 | 384.01 | 460.81 |



A: Moving Panels (screen width when folded into the bath 228mm)
 ○ Recommended shower head position



SecureSeal 4 Fold - *with Storage*

4 Fold with storage

| Size | Adjustment | Order Code | Price £ Exc. VAT | Price £ Inc. VAT |
|----------|------------|------------|---------------------|---------------------|
| 800x1500 | 780-800 | MS4 | 384.01 | 460.81 |

Optional SecureSeal Fixed Panel

| | | | | |
|----------|---------|------|--------|--------|
| 300x1500 | 300-320 | MSFP | 181.94 | 218.33 |
|----------|---------|------|--------|--------|



A: Moving Panels (screen width when folded into the bath 228mm) B: Fixed Panel
 Recommended shower head position



SecureSeal 5 Fold

5 Fold

| Size | Adjustment | Order Code | Price £ Exc. VAT | Price £ Inc. VAT |
|-----------|------------|------------|---------------------|---------------------|
| 1000x1500 | 980-1000 | MS5 | 432.19 | 518.63 |



A: Moving Panels (screen width when folded into the bath 228mm)
 Recommended shower head position



SecureSeal 5 Fold - *with Storage*

5 Fold with storage

| Size | Adjustment | Order Code | Price £ Exc. VAT | Price £ Inc. VAT |
|-----------|------------|------------|---------------------|---------------------|
| 1000x1500 | 980-1000 | MS5 | 432.19 | 518.63 |

Optional SecureSeal Fixed Panel

| | | | | |
|----------|---------|------|--------|--------|
| 300x1500 | 300-320 | MSFP | 181.94 | 218.33 |
|----------|---------|------|--------|--------|



A: Moving Panels (screen width when folded into the bath 228mm) B: Fixed Panel
 Recommended shower head position

Bath Screens

4_{MM}
GLASS
THICKNESS

6_{MM}
GLASS
THICKNESS

8_{MM}
GLASS
THICKNESS

LIFETIME
GUARANTEE

MERSHIELD
STAYCLEAR

Bath Screens

Innovative design and contemporary aesthetics bring this bathroom favourite to life. This modern collection has been created with the same superb materials and unrelenting attention to detail demonstrated across all MERLYN ranges.

Why choose MERLYN Bath Screens?

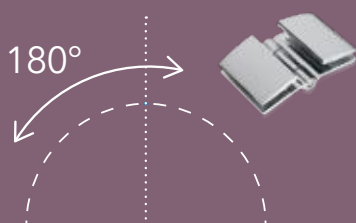

180° inwards swing

The signature piece of this range, the Two Panel Hinged Bath Screen features a secure 180° inwards swing which means you can position the glass where you can comfortably deflect water into the bath and not on to the floor!

Tested for quality & safety

All products are rigorously tested by us and by global health and safety experts to make sure they adhere to the highest quality standards (CE mark info page 101).



Rise and fall

All MERLYN Bath Screens have a rise and fall hinge to make it easier for you to open.

Cleaning

- It is important to clean your MERLYN Bath Screen after every use. Wipe down all the glass and metal parts with a soft cloth.
- Do not allow limescale to build up in hard water areas.
- Ensure that any residual water on the glass is removed after every use.
- Clean the glass regularly using soapy water.
- Do not use abrasive products on any surfaces.

Product Information

- MERLYN Bath Screens are not designed to fit on baths with stepped fronts, roll top rims or integral soap dishes.
- Fitting of screen on baths which have raised head rests or shapes is not recommended.
- There must be no items causing obstruction with the seal and bath, as any of the above may cause leaks.
- When choosing your Bath Screen, please ensure that if your bath has bath handles, they do not interfere with the bath rim area where your screen will be placed.
- When choosing an in-swing or folding Bath Screen, please ensure your swing area is not interfering with any brassware or internal shower features. Similarly, when choosing an out-swing, please ensure the out-swing area is free from any obstructions.
- The MERLYN MB7 2 Panel Hinged Bath Screen is handed so please ensure you state whether you require a right or left handed configuration when ordering.
- It is recommended the shower head position is situated on the same wall to which the Bath Screen is fixed and in the centre of the shower area.





12 Bath Screens to choose from

Whether you are looking for a fresh modern angular style shower screen or a minimalist curved frameless screen, we have a great choice of styles, panel options, open and close features in this range of MERLYN Bath Screens.

Great space saving features

Featuring both design and functionality the 2 Panel Curved Bath Screen is the ultimate in space efficiency. With a sleek chrome towel rail and fitted internal shelves, this piece combines style with purpose for in bath showering.

HydraSEAL

We have created an exciting new feature, exclusive to MERLYN Bath Screens called HydraSEAL

HydraSEAL acts as an extra barrier, sealing the gap between the seal and the pivot point where water can usually escape. It contains a high density foam that compresses onto the bath screen to form a tight seal and restricts water escaping from this problem area.

HydraSEAL is now available on our MB1, MB2, MB3, MB3A and MB3B bath screens.

HydraSEAL creates a barrier to restrict leaking!



Please see page 100 for important tray information.

Bath Screens



MB0
Bathscreen

6MM
GLASS
THICKNESS
LIFETIME
GUARANTEE

Fixed Square

| Fixed Square | | | | |
|--------------|-------|------------|---------------------|---------------------|
| Size | Panel | Order Code | Price £ Exc. VAT | Price £ Inc. VAT |
| 800x1500 | 1 | MB0 | 112.94 | 135.53 |

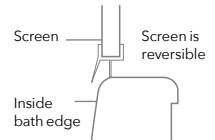
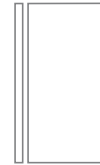
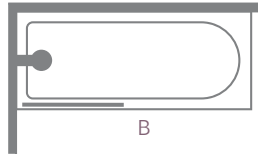

Please ensure product is fitted with moving panel seals in line with bath inside edge.

○ Recommended shower head position



MB1
Bathscreen

Now featuring
HydraSEAL

6MM
GLASS
THICKNESS
LIFETIME
GUARANTEE

Single Curved

| Single Curved | | | | |
|---------------|-------|------------|---------------------|---------------------|
| Size | Panel | Order Code | Price £ Exc. VAT | Price £ Inc. VAT |
| 800x1500 | 1 | MB1 | 154.13 | 184.95 |

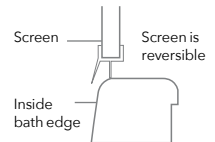
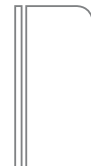
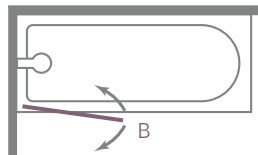

Please ensure product is fitted with moving panel seals in line with bath inside edge.

Door Swing: 90° in and out
B: Radius of Screen Swing = 733mm

○ Recommended shower head position



MB2
Bathscreen

Now featuring
HydraSEAL

MERSFIELD
STAYCLEAR
6MM
GLASS
THICKNESS
LIFETIME
GUARANTEE

Single Square

| Single Square | | | | |
|---------------|-------|------------|---------------------|---------------------|
| Size | Panel | Order Code | Price £ Exc. VAT | Price £ Inc. VAT |
| 800x1500 | 1 | MB2 | 182.34 | 218.81 |

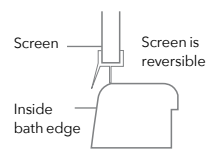
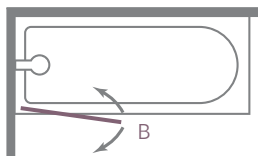

Please ensure product is fitted with moving panel seals in line with bath inside edge.

Door Swing: 90° in and out
B: Radius of Screen Swing = 733mm

○ Recommended shower head position



MB3
Bathscreen

Now featuring
HydraSEAL



2 Panel Curved

| 2 Panel Curved | | | | |
|----------------|-------|------------|---------------------|---------------------|
| Size | Panel | Order Code | Price £ Exc. VAT | Price £ Inc. VAT |
| 1150x1500 | 2 | MB3 | 430.87 | 517.05 |

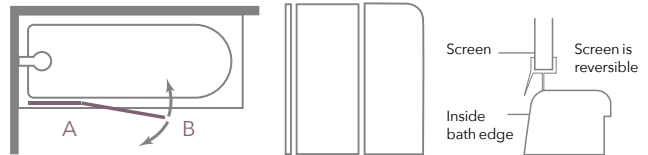

Door Swing: 90° in and out
A: Fixed Panel B: Radius of Screen Swing = 733mm
○ Recommended shower head position

Please ensure product is fitted with moving panel seals in line with bath inside edge.



MB3a
Bathscreen

Now featuring
HydraSEAL



2 Panel Folding Curved

| 2 Panel Folding Curved | | | | |
|------------------------|-------|------------|---------------------|---------------------|
| Size | Panel | Order Code | Price £ Exc. VAT | Price £ Inc. VAT |
| 900x1500 | 2 | MB3A | 254.70 | 305.64 |

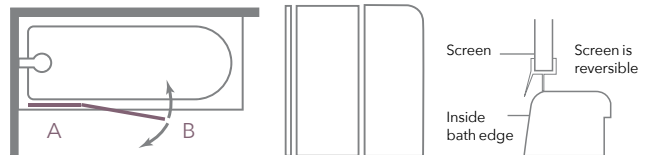

Door Swing: 90° in and out
A: Fixed Panel B: Radius of Screen Swing = 483mm
○ Recommended shower head position

Please ensure product is fitted with moving panel seals in line with bath inside edge.



MB3b
Bathscreen

Now featuring
HydraSEAL



2 Panel Folding Square

| 2 Panel Folding Square | | | | |
|------------------------|-------|------------|---------------------|---------------------|
| Size | Panel | Order Code | Price £ Exc. VAT | Price £ Inc. VAT |
| 900x1500 | 2 | MB3B | 254.70 | 305.64 |

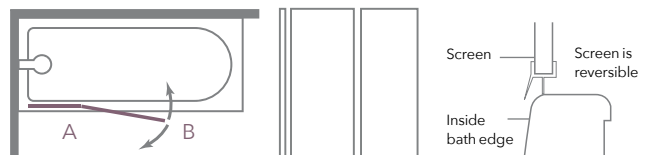

Door Swing: 90° in and out
A: Fixed Panel B: Radius of Screen Swing = 483mm
○ Recommended shower head position

Please ensure product is fitted with moving panel seals in line with bath inside edge.

Bath Screens



4 Fold

4 Fold

| Size | Panel | Order Code | Price £ Exc. VAT | Price £ Inc. VAT |
|----------|-------|------------|---------------------|---------------------|
| 850x1400 | 4 | MB4 | 302.57 | 363.08 |

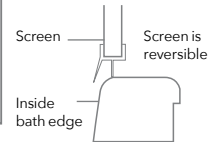
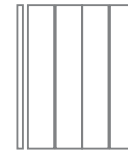

Screen is reversible
Please ensure product is fitted with moving panel seals in line with bath inside edge.

A: Moving Panels (Panel width 200mm)

○ Recommended shower head position



Curtain Rail

Curtain Rail

| Size | Panel | Order Code | Price £ Exc. VAT | Price £ Inc. VAT |
|----------|-------|------------|---------------------|---------------------|
| 300x1500 | 1 | MB5 | 202.73 | 243.27 |

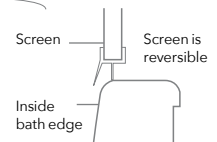
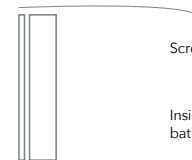
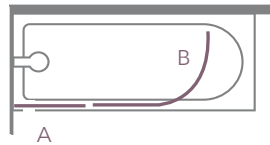

Screen is reversible
Please ensure product is fitted with moving panel seals in line with bath inside edge.

Height is 1550mm including rail

A: Fixed Panel B: Curtain Rail

○ Recommended shower head position



Hinged Square

Hinged Square

| Size | Panel | Order Code | Price £ Exc. VAT | Price £ Inc. VAT |
|----------|-------|------------|---------------------|---------------------|
| 850x1500 | 1 | MB6 | 405.29 | 486.35 |

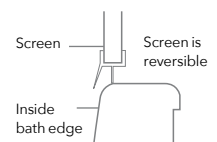
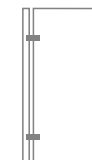
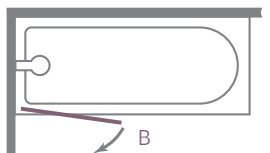

Screen is reversible
Please ensure product is fitted with moving panel seals in line with bath inside edge.

Door Swing: 90° outward swing only

B: Radius of Screen Swing = 810mm

○ Recommended shower head position



MB7
Bathscreen



2 Panel Hinged

2 Panel Hinged

| Size | Panel | Order Code | Price £ Exc. VAT | Price £ Inc. VAT |
|----------|-------|---------------------|---------------------|---------------------|
| 900x1500 | 2 | MB7L (Left handed) | 494.00 | 592.80 |
| 900x1500 | 2 | MB7R (Right handed) | 494.00 | 592.80 |

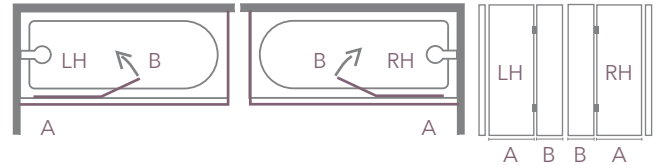

Door Swing: 180 Degrees inwards only

A: Fixed Panel = 497mm

B: Radius of Screen Swing = 383mm

☐ ○ Recommended shower head position

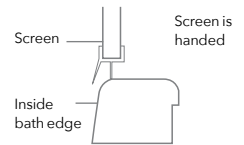

Please ensure product is fitted with moving panel seals in line with bath inside edge.



MB8
Bathscreen



2 Panel Folding

2 Panel Folding

| Size | Panel | Order Code | Price £ Exc. VAT | Price £ Inc. VAT |
|-----------|-------|------------|---------------------|---------------------|
| 1100x1500 | 2 | MB8 | 491.32 | 589.58 |

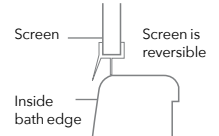
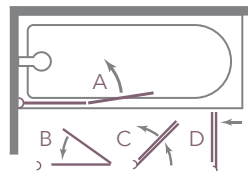

Please ensure product is fitted with moving panel seals in line with bath inside edge.

Door Swing: 180 degree radius of screen swing inwards and outwards

☐ ○ Recommended shower head position



MB9
Bathscreen



3 Panel Folding

3 Panel Folding

| Size | Panel | Order Code | Price £ Exc. VAT | Price £ Inc. VAT |
|-----------|-------|------------|---------------------|---------------------|
| 1400x1500 | 3 | MB9 | 614.43 | 737.32 |

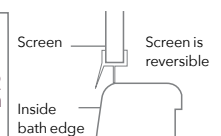
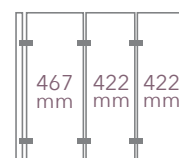
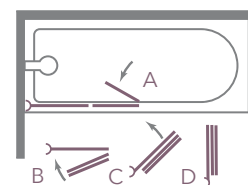

Please ensure product is fitted with moving panel seals in line with bath inside edge.

Door Swing: 180 degree radius of screen swing inwards and outwards

☐ ○ Recommended shower head position

Bath Screens



Luxurious textured slate trays

Beautifully handcrafted and ultra-low slate trays, elegant in appearance and luxurious to touch. With 5 finishes to choose from - Pure Black, Sandstone, Slate Black, White, and Fossil Grey.

These trays will bring an element of natural beauty and a truly designer finish to your bathroom.

Why choose TrueStone Trays?



Slate Black TrueStone Tray



White TrueStone Tray

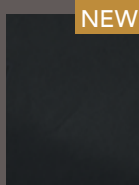

Pure Black

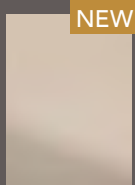

Sandstone

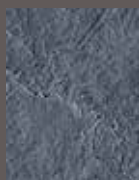

Slate Black

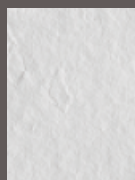

White

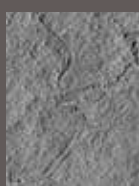

Fossil Grey



NEW Pure Black TrueStone tray

Feature Highlights

- Ultra slim: Only 30mm in height
- Handcrafted from high grade stone resin
- 5 colour options - Pure Black, Sandstone, Slate Black, White and Fossil Grey
- Integrated discreet waste
- Luxurious textured finish
- Can be fitted on or level with floor
- Comes with 90mm fast flow waste
- Please Note: Images are for illustrative purposes only. The colours and finishes shown in the catalogue are as accurate as possible within the limits of the printing process.

Ultra slim tray 30mm

Branded waste cover

White TrueStone Tray

Rectangular Tray

Rectangular Tray (comes with MERLYN 90mm fast flow waste)

| Size | Colour | Order Code | Price £ Exc. VAT | Price £ Inc. VAT |
|----------|-----------------------|------------|---------------------|---------------------|
| 1000x800 | Pure Black NEW | T108RTB | 468.92 | 562.70 |
| 1000x800 | Sandstone NEW | T108RTS | 468.92 | 562.70 |
| 1000x800 | Slate Black | T108RTG | 468.92 | 562.70 |
| 1000x800 | White | T108RTW | 468.92 | 562.70 |
| 1000x800 | Fossil Grey | T108RTF | 468.92 | 562.70 |
| 1200x800 | Pure Black NEW | T128RTB | 555.53 | 666.63 |
| 1200x800 | Sandstone NEW | T128RTS | 555.53 | 666.63 |
| 1200x800 | Slate Black | T128RTG | 555.53 | 666.63 |
| 1200x800 | White | T128RTW | 555.53 | 666.63 |
| 1200x800 | Fossil Grey | T128RTF | 555.53 | 666.63 |
| 1200x900 | Pure Black NEW | T129RTB | 623.92 | 748.70 |
| 1200x900 | Sandstone NEW | T129RTS | 623.92 | 748.70 |
| 1200x900 | Slate Black | T129RTG | 623.92 | 748.70 |
| 1200x900 | White | T129RTW | 623.92 | 748.70 |
| 1200x900 | Fossil Grey | T129RTF | 623.92 | 748.70 |
| 1400x800 | Pure Black NEW | T148RTB | 617.39 | 740.86 |
| 1400x800 | Sandstone NEW | T148RTS | 617.39 | 740.86 |
| 1400x800 | Slate Black | T148RTG | 617.39 | 740.86 |
| 1400x800 | White | T148RTW | 617.39 | 740.86 |
| 1400x800 | Fossil Grey | T148RTF | 617.39 | 740.86 |
| 1400x900 | Pure Black NEW | T149RTB | 679.24 | 815.09 |
| 1400x900 | Sandstone NEW | T149RTS | 679.24 | 815.09 |
| 1400x900 | Slate Black | T149RTG | 679.24 | 815.09 |
| 1400x900 | White | T149RTW | 679.24 | 815.09 |
| 1400x900 | Fossil Grey | T149RTF | 679.24 | 815.09 |
| 1500x800 | Pure Black NEW | T158RTB | 653.26 | 783.91 |
| 1500x800 | Sandstone NEW | T158RTS | 653.26 | 783.91 |
| 1500x800 | Slate Black | T158RTG | 653.26 | 783.91 |

Please see page 98 and 100 for important tray information.

Rectangular Tray continued...

| Size | Colour | Order Code | Price £ Exc. VAT | Price £ Inc. VAT |
|----------|-----------------------|------------|---------------------|---------------------|
| 1500x800 | White | T158RTW | 653.26 | 783.91 |
| 1500x800 | Fossil Grey | T158RTF | 653.26 | 783.91 |
| 1500x900 | Pure Black NEW | T159RTB | 831.43 | 997.71 |
| 1500x900 | Sandstone NEW | T159RTS | 831.43 | 997.71 |
| 1500x900 | Slate Black | T159RTG | 831.43 | 997.71 |
| 1500x900 | White | T159RTW | 831.43 | 997.71 |
| 1500x900 | Fossil Grey | T159RTF | 831.43 | 997.71 |
| 1600x800 | Pure Black NEW | T168RTB | 697.80 | 837.36 |
| 1600x800 | Sandstone NEW | T168RTS | 697.80 | 837.36 |
| 1600x800 | Slate Black | T168RTG | 697.80 | 837.36 |
| 1600x800 | White | T168RTW | 697.80 | 837.36 |
| 1600x800 | Fossil Grey | T168RTF | 697.80 | 837.36 |
| 1600x900 | Pure Black NEW | T169RTB | 900.70 | 1080.84 |
| 1600x900 | Sandstone NEW | T169RTS | 900.70 | 1080.84 |
| 1600x900 | Slate Black | T169RTG | 900.70 | 1080.84 |
| 1600x900 | White | T169RTW | 900.70 | 1080.84 |
| 1600x900 | Fossil Grey | T169RTF | 900.70 | 1080.84 |
| 1700x800 | Pure Black NEW | T178RTB | 765.86 | 919.03 |
| 1700x800 | Sandstone NEW | T178RTS | 765.86 | 919.03 |
| 1700x800 | Slate Black | T178RTG | 765.86 | 919.03 |
| 1700x800 | White | T178RTW | 765.86 | 919.03 |
| 1700x800 | Fossil Grey | T178RTF | 765.86 | 919.03 |
| 1700x900 | Pure Black NEW | T179RTB | 930.40 | 1116.49 |
| 1700x900 | Sandstone NEW | T179RTS | 930.40 | 1116.49 |
| 1700x900 | Slate Black | T179RTG | 930.40 | 1116.49 |
| 1700x900 | White | T179RTW | 930.40 | 1116.49 |
| 1700x900 | Fossil Grey | T179RTF | 930.40 | 1116.49 |

DISCLAIMER

Please ensure that the shower head is not positioned directly over the waste as this may restrict flow rate.



Square Tray

Square Tray (comes with MERLYN 90mm fast flow waste)

| Size | Colour | Order Code | Price £ Exc. VAT | Price £ Inc. VAT |
|---------|-----------------------|------------|---------------------|---------------------|
| 900x900 | Pure Black NEW | T90RTB | 493.66 | 592.39 |
| 900x900 | Sandstone NEW | T90RTS | 493.66 | 592.39 |
| 900x900 | Slate Black | T90RTG | 493.66 | 592.39 |
| 900x900 | White | T90RTW | 493.66 | 592.39 |
| 900x900 | Fossil Grey | T90RTF | 493.66 | 592.39 |



Quadrant Tray

Quadrant Tray (comes with MERLYN 90mm fast flow waste)

| Size | Colour | Order Code | Price £ Exc. VAT | Price £ Inc. VAT |
|---------|-----------------------|------------|---------------------|---------------------|
| 900x900 | Pure Black NEW | T90QB | 441.69 | 530.03 |
| 900x900 | Sandstone NEW | T90QS | 441.69 | 530.03 |
| 900x900 | Slate Black | T90QG | 441.69 | 530.03 |
| 900x900 | White | T90QW | 441.69 | 530.03 |
| 900x900 | Fossil Grey | T90QF | 441.69 | 530.03 |



Offset Quadrant Tray

Offset Quadrant Tray (comes with MERLYN 90mm fast flow waste)

| Size | Colour | Order Code | Price £ Exc. VAT | Price £ Inc. VAT |
|----------|------------------------|--------------|---------------------|---------------------|
| 1000x800 | Pure Black NEW | T108HB Lor R | 579.28 | 695.14 |
| 1000x800 | Sandstone NEW | T108HS Lor R | 579.28 | 695.14 |
| 1000x800 | Slate Black NEW | T108HG Lor R | 579.28 | 695.14 |
| 1000x800 | White NEW | T108HW Lor R | 579.28 | 695.14 |
| 1000x800 | Fossil Grey NEW | T108HF Lor R | 579.28 | 695.14 |
| 1200x900 | Pure Black NEW | T129HB Lor R | 679.24 | 815.09 |
| 1200x900 | Sandstone NEW | T129HS Lor R | 679.24 | 815.09 |
| 1200x900 | Slate Black | T129HG Lor R | 679.24 | 815.09 |
| 1200x900 | White | T129HW Lor R | 679.24 | 815.09 |
| 1200x900 | Fossil Grey | T129HF Lor R | 679.24 | 815.09 |

This product is handed please choose L for left and R for right when ordering.



Left Handed (L)



Right Handed (R)



Pure Black



Sandstone

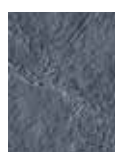

Slate Black



White

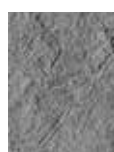

Fossil Grey

Sleek minimalist design

This tray is sleek and ultra slim, creating a modern and contemporary feel for any bathroom. At only 25mm high this tray can be fitted flush to the floor encompassing all the benefits of a wetroom floor and accessibility but without the costly wetroom installation. The discreet integrated waste cover ensures it is aesthetically pleasing to the eye but highly functional.

THE LEVEL25 TRAY IS CAPPED WITH AN EASY TO CLEAN SURFACE THAT PROVIDES A CHEMICAL RESISTANT, ANTI-BACTERIAL SOLUTION DUE TO IT'S ULTRA-SMOOTH, NON-POROUS SURFACE.

Level25 Trays



Quad Tray

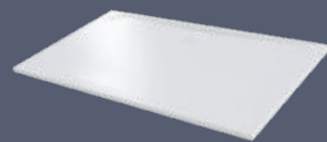

Rectangular Tray



Waste Cover

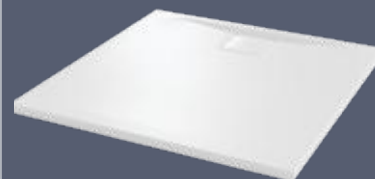

Square Tray

Feature Highlights

- Ultra slim 25mm low level tray
- Sleek minimalist design
- Discreet integrated waste cover
- Can be fitted on or level with floor
- Comes with 90mm fast flow waste
- Shower tray 25 year guarantee
- Available in square, rectangular and quadrant

Level 25 Tray

1. Top Acrylic capped ABS layer
2. Stone Resin
3. Bottom ABS layer
(encapsulates the tray)



LEVEL25[®] Square Tray

Square Tray (comes with MERLYN 90mm fast flow waste)

| Size | Order Code | Price £ Exc. VAT | Price £ Inc. VAT |
|---------|------------|---------------------|---------------------|
| 900x900 | L90SQ | 260.81 | 312.98 |



Waste Cover

DISCLAIMER

Please ensure that the shower head is not positioned directly over the waste as this may restrict flow rate.

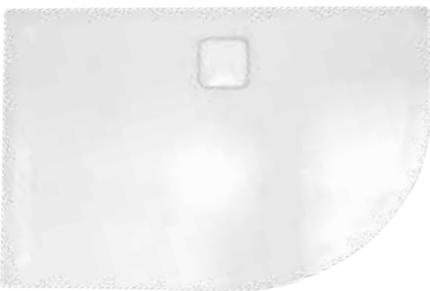

LEVEL25[®] Quadrant Tray

Quadrant Tray (comes with MERLYN 90mm fast flow waste)

| Size | Order Code | Price £ Exc. VAT | Price £ Inc. VAT |
|---------|------------|---------------------|---------------------|
| 900x900 | L90Q | 305.10 | 366.12 |

Please see page 98 and 100 for important tray information.



LEVEL25[®] Rectangular Tray

Rectangular Tray (comes with MERLYN 90mm fast flow waste)

| Size | Order Code | Price £ Exc. VAT | Price £ Inc. VAT |
|----------|------------|---------------------|---------------------|
| 1000x800 | L108RT | 260.81 | 312.98 |
| 1000x900 | L109RT | 284.63 | 341.56 |
| 1100x800 | L118RT | 284.63 | 341.56 |
| 1100x900 | L119RT | 284.63 | 341.56 |
| 1200x800 | L128RT | 284.63 | 341.56 |
| 1200x900 | L129RT | 296.54 | 355.84 |
| 1300x800 | L138RT | 423.93 | 508.71 |
| 1300x900 | L139RT | 423.93 | 508.71 |
| 1400x800 | L148RT | 423.93 | 508.71 |
| 1400x900 | L149RT | 423.93 | 508.71 |
| 1500x800 | L158RT | 456.12 | 547.34 |
| 1500x900 | L159RT | 456.12 | 547.34 |
| 1600x800 | L168RT | 475.18 | 570.21 |
| 1600x900 | L169RT | 475.18 | 570.21 |
| 1700x800 | L178RT | 540.67 | 648.81 |
| 1700x900 | L179RT | 544.25 | 653.10 |

DISCLAIMER

Please note: The Level 25 tray must be fitted with the waste positioned along the back wall and not to the front.

The Level25 tray is capped with an easy to clean surface that provides a chemical resistant, anti-bacterial solution due to it's ultra-smooth, non-porous surface.

LEVEL25[®] Offset Quadrant Tray

Offset Quadrant Tray (comes with MERLYN 90mm fast flow waste)

| Size | Order Code | Price £ Exc. VAT | Price £ Inc. VAT |
|----------|------------|---------------------|---------------------|
| 1200x900 | L129QL | 418.52 | 502.22 |
| 1200x900 | L129QR | 418.52 | 502.22 |

MSTONE



Function with style

The MStone double skin stone resin tray is sleek and sophisticated in design. A highly engineered tray providing rigidity and strength, combined with a relatively low weight. MStone trays are ideal for 'low level' installation. Alternatively, you can raise your tray. In such cases you will need the MStone shower tray panel kit. MStone panel kits are available separately.

THE MSTONE TRAY IS CAPPED WITH AN EASY TO CLEAN SURFACE THAT PROVIDES A CHEMICAL RESISTANT, ANTI-BACTERIAL SOLUTION DUE TO IT'S ULTRA-SMOOTH, NON-POROUS SURFACE.



Why choose MStone Trays?



Fast flow waste

90mm fast flow waste, includes hair trap and chrome cover.



Adjustable leg system

Graduated adjustable leg system. Bottom acrylic capped ABS layer.



Easy fit tray panel

Graduated adjustable leg and easy fit tray panel kit.



MStone Tray

1. Top Acrylic capped ABS layer
2. Stone Resin
3. Bottom ABS layer (encapsulates the tray)

Feature Highlights

- Double skinned for added rigidity
- 50mm high to achieve minimalist design
- 130mm high including tray panel set
- The MStone tray is capped with an easy to clean surface that provides a chemical resistant, anti-bacterial solution due to it's ultra-smooth non-porous surface.
- Comes with 90mm fast flow waste
- More than 30 sizes available
- Available as low level or with tray panel kits for easy installation
- Shower tray Lifetime Guarantee*

*This guarantee covers manufacturing defects only.



Rectangular Tray

Rectangular Tray (comes with MERLYN 90mm fast flow waste)

| Size | Tray Panel Kit (Order Separately) | Order Code | Price £ Exc. VAT | Price £ Inc. VAT |
|-----------|--------------------------------------|---------------|---------------------|---------------------|
| 900x760 | Kit 4 | D976RT | 180.90 | 217.08 |
| 1000x800 | Kit 4 | D108RT | 204.32 | 245.18 |
| 1100x760 | Kit 4 | D1176RT | 229.04 | 274.85 |
| 1100x800 | Kit 4 | D118RT | 217.33 | 260.79 |
| 1200x700 | Kit 4 | D127RT | 214.71 | 257.65 |
| 1200x760 | Kit 4 | D1276RT | 214.71 | 257.65 |
| 1200x800 | Kit 4 | D128RT | 219.93 | 263.91 |
| 1200x900 | Kit 4 | D129RT | 232.95 | 279.54 |
| 1400x800 | Kit 3 | D148RT | 322.40 | 386.88 |
| 1400x900 | Kit 3 | D149RT | 335.67 | 402.80 |
| 1500x700 | Kit 3 | D157RT | 367.52 | 441.02 |
| 1500x800 | Kit 3 | D158RT | 367.52 | 441.02 |
| 1500x900 | Kit 3 | D159RT | 367.52 | 441.02 |
| 1600x800 | Kit 3 | D168RT | 432.50 | 519.01 |
| 1600x900 | Kit 3 | D169RT | 432.50 | 519.01 |
| 1685x700 | Kit 3 | D177RT | 436.50 | 523.80 |
| 1680x760 | Kit 3 | D1776RT | 436.50 | 523.80 |
| *1700x800 | Kit 3 | D178RT | 516.10 | 619.32 |

Tray Panel Kit (including Legs)

| | | | | |
|----------|-------|------|-------|--------|
| 1700x700 | Kit 3 | DRK3 | 88.50 | 106.20 |
| 1700x760 | Kit 4 | DRK4 | 88.50 | 106.20 |

The MStone tray is capped with an easy to clean surface that provides a chemical resistant, anti-bacterial solution due to it's ultra-smooth, non-porous surface.



*Waste is centered for 1700 x 800 tray - D178RT

Please see page 98 and 100 for important tray information.

MStone
trays



MSTONE

Square Tray

Square Tray (comes with MERLYN 90mm fast flow waste)

| Size | Tray Panel Kit (Order Separately) | Order Code | Price £ Exc. VAT | Price £ Inc. VAT |
|------|--------------------------------------|------------|---------------------|---------------------|
| 760 | Kit 4 | D76SQ | 115.81 | 138.98 |
| 800 | Kit 4 | D80SQ | 128.84 | 154.60 |
| 900 | Kit 4 | D90SQ | 180.90 | 217.08 |

Tray Panel Kit (including Legs)

| | | | |
|-------|------|-------|--------|
| Kit 4 | DRK4 | 88.50 | 106.20 |
|-------|------|-------|--------|



MSTONE

Quadrant Tray

Quadrant Tray (comes with MERLYN 90mm fast flow waste)

| Size | Tray Panel Kit (Order Separately) | Order Code | Price £ Exc. VAT | Price £ Inc. VAT |
|------|--------------------------------------|------------|---------------------|---------------------|
| 800 | Kit 2 | D80Q | 165.28 | 198.33 |
| 900 | Kit 2 | D90Q | 180.90 | 217.08 |
| 1000 | Kit 5 | D100Q | 236.03 | 283.23 |

Tray Panel Kit (including Legs)

| | | | |
|-------|------|-------|--------|
| Kit 2 | DRK2 | 88.50 | 106.20 |
| Kit 5 | DRK5 | 88.50 | 106.20 |



MSTONE

Offset Quadrant Tray

Offset Quadrant Tray (comes with MERLYN 90mm fast flow waste)

| Size | Tray Panel Kit (Order Separately) | Order Code | Price £ Exc. VAT | Price £ Inc. VAT |
|------------|--------------------------------------|------------|---------------------|---------------------|
| 900 X 760 | Kit 1 | D976QL | 245.96 | 295.15 |
| 900 X 760 | Kit 1 | D976QR | 245.96 | 295.15 |
| 1000 X 800 | Kit 1 | D108QL | 232.95 | 279.54 |
| 1000 X 800 | Kit 1 | D108QR | 232.95 | 279.54 |
| 1200 X 800 | Kit 1 | D128QL | 244.64 | 293.57 |
| 1200 X 800 | Kit 1 | D128QR | 244.64 | 293.57 |
| 1200 X 900 | Kit 1 | D129QL | 257.67 | 309.20 |
| 1200 X 900 | Kit 1 | D129QR | 257.67 | 309.20 |

Tray Panel Kit (including Legs)

| | | | |
|-------|------|-------|--------|
| Kit 1 | DRK1 | 88.50 | 106.20 |
|-------|------|-------|--------|

Waste Complete

| | | |
|------|-------|-------|
| DWAS | 20.80 | 24.96 |
|------|-------|-------|

White Waste Cap Option

| | | |
|------------|------|-------|
| DWASCAPWHT | 9.95 | 11.94 |
|------------|------|-------|

Image above shown as Left Handed (L)
Please choose L for Left or R for Right when ordering.



Left Handed (L)



Right Handed (R)

Please see page 98 and 100 for important tray information.

MERLYN *shower wiper*

Introducing the MERLYN shower wiper to help you keep your enclosure sparkling for years to come. Includes a designer chrome branded holder to keep it within your reach.

| Order Code | Price £ Exc. VAT | Price £ Exc. VAT |
|------------|---------------------|---------------------|
| MG201WIPER | 41.84 | 50.21 |



MERLYN *glass shelf*

| Order Code | Price £ Exc. VAT | Price £ Exc. VAT |
|------------|---------------------|---------------------|
| DWHSHELF | 97.06 | 116.48 |



www.merlynshowering.com

Product Information

We have produced this product section to help you with your purchasing decision. For further information please contact your local stockist, details of which can be found at www.merlynshowering.com



Product information

All products are manufactured in accordance with EN14428 and utilise toughened safety glass to EN 12150.

All shower trays are manufactured in accordance with EN14527.

All doors feature adjustable wall profiles to compensate for out-of-true walls and have micro adjustment features for fine tuning to obtain a perfect fit and operating action.

All enclosures, wetrooms and panels are Power Shower approved - will retain water under normal showering conditions.

Water retention is maintained in all products under normal showering conditions.

A selection of MERLYN enclosures are frameless in design. Spray/mist may escape therefore we would recommend use of these enclosures with tiled floors.

Opened cartons can not be returned. Returns carry a £40 box charge or £60 per unit where the sale is less than 30 days old. Returns over 30 days old will not be accepted.

All products are supplied complete with full installation instructions and the necessary fixings.

Check with your dealer for accurate matching of material samples. Product descriptions do not imply the use of precious or valuable materials.

Our policy of reviewing product design and development on a regular basis means MERLYN reserve the right to change product specifications and prices without notice.

Only shower enclosures, panels, MStone shower trays and bath screens are covered by the Lifetime Guarantee. Please contact the MERLYN sales team for more details.

Glass shattering and parts subject to wear are not covered by the Lifetime Guarantee.

For full details on all product ranges please contact MERLYN Showering on 0808 1011429 or log onto www.merlynshowering.com.

Trays shown in this catalogue are for illustrative purposes only.

Images are for illustration purposes only. The colours and finishes shown in the catalogue are as accurate as possible within the limits of the printing process. The positioning of all showering heads in the brochure is for illustrative purposes only.

All descriptions, specifications and particulars contained in this brochure are intended merely to represent a general idea of the products described herein and none of these form part of any contract to give rise to any independent or collateral liability upon the company.

Cleaning

- It is important to clean your MERLYN shower door and tray after every use. Wipe down all the glass and metal parts with a soft cloth.
- Do not allow lime scale to build up in hard water areas.
- Ensure that any residual water on the glass is removed after every use.
- Clean the glass regularly using soapy water.
- Do not use abrasive products on any surfaces.
- Install the enclosure in a well ventilated area.
- For more information on Merfield Stayclear glass please see page 08 of this brochure.

Information and maintenance

Always read the instructions on the packaging, chrome is vulnerable to acid attack and some strong household cleaners including strong disinfectants, denture cleaners, hair dyes, wine making chemicals and photographic chemicals may contain acid. These materials may have a varying effect on the surface from black spots/streaks (which cannot be removed) to pitting the surface. Contact with these materials should be avoided.

Important shower tray information

- It is up to the designer or installer to ensure that the tray and enclosure combination is arranged in such a way that water retention meets the customers needs.
- The waste has the capacity to carry away 29L/Min. High powered systems may exceed this. Please check with the manufacturer.
- Please ensure that the shower head is not positioned directly over the waste as this may restrict water flow rate.
- Please ensure that the colour and size of shower tray are as per your order before installation.
- You must inspect the product thoroughly before installation. Fitting the product is acceptance of quality.
- The trays are handmade from natural material. Please allow for height variances due to manufacturing tolerances.
- For open ended shower screens please consult your installer.
- Shower trays must be fitted as per the fitting instruction. Deviation from the pre installation checks or fitting installation will void the guarantee.
- When wet, the surface of the majority of shower trays will show an increase in the potential for slipping. This is particularly the case when soap, shampoo, bath oil etc. are used. It is important that designers, installers and users are aware of this.

Important

Although shower door and enclosure sizes are related to tray sizes it is important to note that most shower trays are tiled down to the rim, often over an 'up-stand'. The finished installation space may be less than the nominal tray size. MERLYN shower units are made to suit this remaining space.

Tray Finish min-max

The Tray Finish applies when fitting a door and a tray. These are the minimum and maximum dimensions that a shower door or enclosure will fit using standard wall profiles.

Tray finish

To find the correct Tray Finish dimension:

In a recess: Measure from the finished, tiled wall to the opposite finished, tiled wall.

In a corner: Measure from the finished, tiled wall to the edge of the tray.

Note: If the wall/walls are leaning in, this will further reduce your Tray Finish.

Adjustment

This is the min and max adjustment of the actual enclosure. These are the adjustment dimensions of the actual door excluding the tray. Therefore, these are the dimensions to follow when installing a enclosure in a wetroom application without a tray.

The guide below may be helpful in taking measurements to determine the shower door or enclosure size required. Dimensions given in this publication are in millimetres, are approximate and may vary with adjustment. They are subject to change without notice.

Please note that when a tray is fitted it is essential that the tray is level before any doors or enclosures are fitted.

Recess Location

Take the measurements after the tray is installed and the walls are tiled.

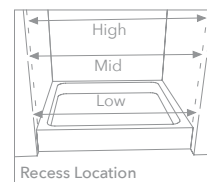

Recess Location

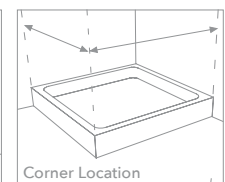

Corner Location

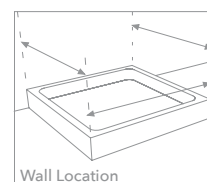

Wall Location

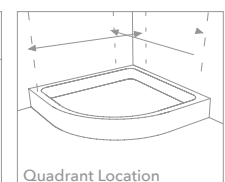

Quadrant Location

Extension Profiles

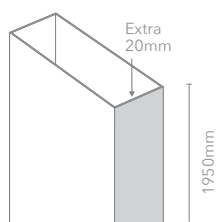

10 Series Sliding Door

| Order Code | Height | Price £ Exc. VAT | Price £ Inc. VAT |
|------------|--------|------------------------|------------------------|
| M108EXTSL | 1950 | 83.00 | 99.60 |

Series 10 extension profile: extra 20mm.
Sliding Door can only be used with one extension profile.

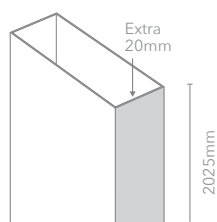

10 Series Pivot - Hinged Side

| Order Code | Height | Price £ Exc. VAT | Price £ Inc. VAT |
|------------|--------|------------------------|------------------------|
| M108EXTPVH | 2025 | 83.00 | 99.60 |

Series 10 extension profile: extra 20mm.
Series 10 Pivot Hinged Side extension to be fitted on the same side as the door hinge.

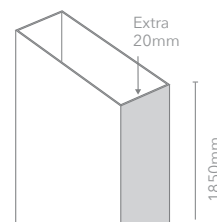

10 Series Quadrant

| Order Code | Height | Price £ Exc. VAT | Price £ Inc. VAT |
|------------|--------|------------------------|------------------------|
| M108EXTQU | 1850 | 83.00 | 99.60 |

Series 10 extension profile: extra 20mm.

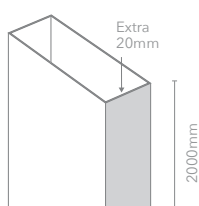

10 Series Pivot - Closing Side

| Order Code | Height | Price £ Exc. VAT | Price £ Inc. VAT |
|------------|--------|------------------------|------------------------|
| M108EXTPV | 2000 | 83.00 | 99.60 |

Series 10 extension profile: extra 20mm.
Series 10 Pivot Side Panel extension to be fitted on the closing post, Inline Panel or Side Panel side.

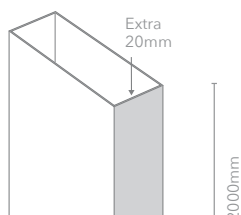

8 Series Frameless - Hinge and Quadrant Doors

| Order Code | Height | Price £ Exc. VAT | Price £ Inc. VAT |
|------------|--------|------------------------|------------------------|
| A0614A0 | 2000 | 68.35 | 82.02 |

8 Series Frameless extension profile: extra 20mm.

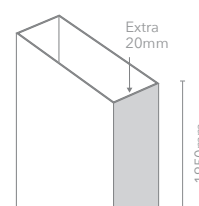

8 Series Frameless - Hinged Bifold Door

| Order Code | Height | Price £ Exc. VAT | Price £ Inc. VAT |
|------------|--------|------------------------|------------------------|
| M8FBEXT20 | 1950 | 64.13 | 76.95 |

8 Series Frameless extension profile: extra 20mm.

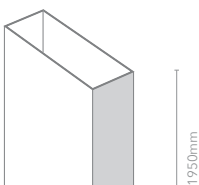

8 Series Frameless - Pivot / Pivot & Inline

| Order Code | Height | Price £ Exc. VAT | Price £ Inc. VAT |
|------------|--------|------------------------|------------------------|
| M8FBEXT20 | 1950 | 64.13 | 76.95 |

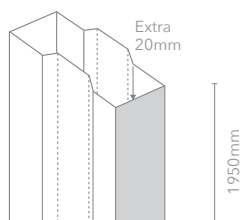

8 Series

| Order Code | Height | Price £ Exc. VAT | Price £ Inc. VAT |
|------------|--------|------------------------|------------------------|
| M8EXT20 | 1950 | 62.78 | 75.33 |

8 Series extension profile: extra 20mm.

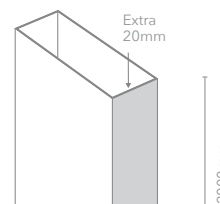

6 Series Frameless

| Order Code | Height | Price £ Exc. VAT | Price £ Inc. VAT |
|------------|--------|------------------------|------------------------|
| S6FEXT | 2000 | 65.71 | 78.86 |

6 Series Frameless extension profile: extra 20mm.

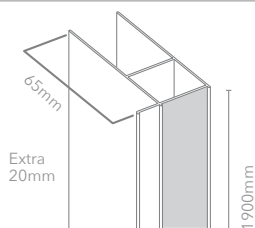

6 Series

| Order Code | Height | Price £ Exc. VAT | Price £ Inc. VAT |
|------------|--------|------------------------|------------------------|
| M6EXT | 1900 | 57.78 | 69.34 |

Series 6 extension profile: extra 20mm.
No extension profile available for: Showerwall.

Product Information

Waste Positions

TrueStone Trays

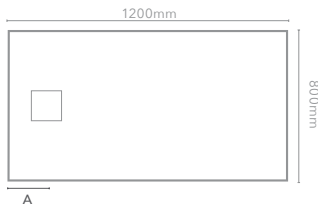

Rectangular Tray

| Size | Waste Position (A) | Waste Position (B) |
|----------|--------------------|--------------------|
| 1000x800 | 200 | 400 |
| 1200x800 | 250 | 400 |
| 1200x900 | 250 | 450 |
| 1400x800 | 350 | 400 |
| 1400x900 | 350 | 450 |
| 1500x800 | 400 | 400 |
| 1500x900 | 400 | 450 |
| 1600x800 | 450 | 400 |
| 1600x900 | 450 | 450 |
| 1700x800 | 500 | 400 |
| 1700x900 | 500 | 450 |

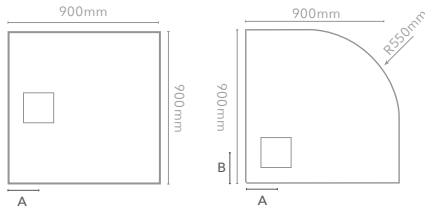

Square Tray

| Size | Waste Position (A) | Waste Position (B) |
|---------|--------------------|--------------------|
| 900x900 | 270 | 450 |

Quadrant Tray

| Size | Waste Position (A) | Waste Position (B) |
|---------|--------------------|--------------------|
| 900x900 | 270 | 270 |

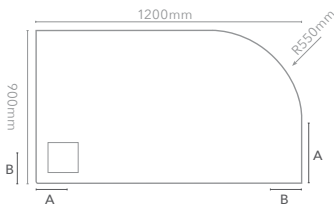

Offset Quadrant Tray

| Size | Waste Position (A) | Waste Position (B) |
|----------|--------------------|--------------------|
| 1200x900 | 270 | 270 |
| 1200x800 | 270 | 270 |

Please Note: For all trays, waste dimensions are to the centre of waste.

Level 25 Trays

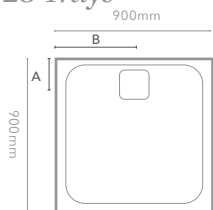

Square Tray

| Size | Waste Position (A) | Waste Position (B) |
|---------|--------------------|--------------------|
| 900x900 | 121.5 | 450 |

Level 25 Trays

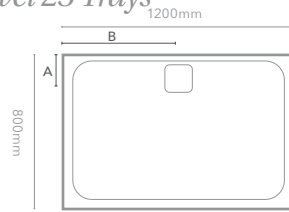

Rectangular Tray

| Size | Waste Position (A) | Waste Position (B) |
|----------|--------------------|--------------------|
| 1000x800 | 121.5 | 500 |
| 1000x900 | 121.5 | 500 |
| 1100x800 | 121.5 | 550 |
| 1100x900 | 121.5 | 550 |
| 1200x800 | 121.5 | 600 |
| 1200x900 | 121.5 | 600 |
| 1300x800 | 121.5 | 650 |
| 1300x900 | 121.5 | 650 |
| 1400x800 | 121.5 | 700 |
| 1400x900 | 121.5 | 700 |
| 1500x800 | 121.5 | 750 |
| 1500x900 | 121.5 | 750 |
| 1600x800 | 121.5 | 800 |
| 1600x900 | 121.5 | 800 |
| 1700x800 | 121.5 | 850 |
| 1700x900 | 121.5 | 850 |

Quadrant Tray

Offset Quadrant Tray

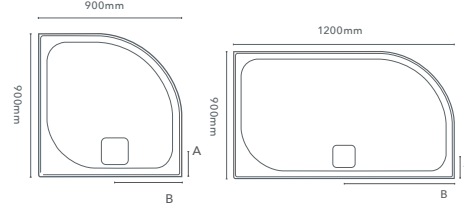

Quadrant Trays

| Size | Waste Position (A) | Waste Position (B) |
|------------|--------------------|--------------------|
| 900 x 900 | 121.5 | 450 |
| 1200 x 900 | 121.5 | 600 |

MStone Trays



Rectangular Tray

| Size | Waste Position (A) | Waste Position (B) |
|----------|--------------------|--------------------|
| 900x760 | 147 | |
| 1000x800 | 147 | |
| 1100x760 | 147 | |
| 1100x800 | 147 | |
| 1200x700 | 147 | |
| 1200x760 | 147 | |
| 1200x800 | 147 | |
| 1200x900 | 147 | |
| 1400x800 | 147 | |
| 1400x900 | 147 | |
| 1500x700 | 147 | |
| 1500x800 | 147 | |
| 1500x900 | 147 | |
| 1600x800 | 147 | |
| 1600x900 | 147 | |
| 1685x700 | 147 | |
| 1680x760 | 147 | |

MStone Trays Continued...

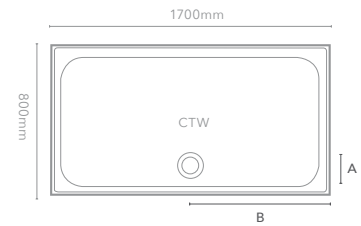

Rectangular Tray

| Size | Waste Position (A) | Waste Position (B) |
|----------|--------------------|--------------------|
| 1700x800 | 130 | 850 |

Waste is centred for 1700x800 tray - D178RT

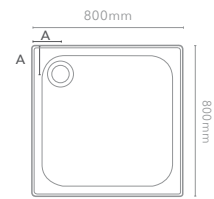

Square Tray

| Size | Waste Position (A) | Waste Position (B) |
|------|--------------------|--------------------|
| 760 | 147 | |
| 800 | 147 | |
| 900 | 147 | |

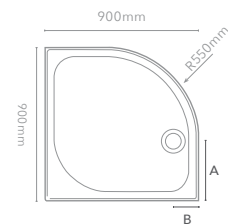

Quadrant Tray

| Size | Waste Position (A) | Waste Position (B) |
|------|--------------------|--------------------|
| 800 | 250 | 130 |
| 900 | 350 | 130 |
| 1000 | 350 | 130 |

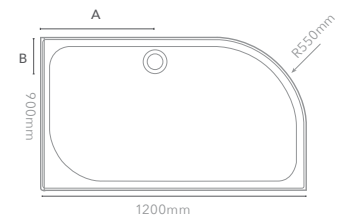

Offset Quadrant Tray

| Size | Waste Position (A) | Waste Position (B) |
|------------|--------------------|--------------------|
| 900x760 L | 250 | 130 |
| 900x760 R | 250 | 130 |
| 1000x800 L | 350 | 130 |
| 1000x800 R | 350 | 130 |
| 1200x800 L | 450 | 130 |
| 1200x800 R | 450 | 130 |
| 1200x900 L | 450 | 130 |
| 1200x900 R | 450 | 130 |
| 1400x800 L | 510 | 300 |
| 1400x800 R | 510 | 300 |

DISCLAIMER

Please ensure that the shower head is not positioned directly over the waste as this may restrict flow rate.

CE & EN Information

The CE marking on MERLYN enclosures is a declaration that the product complies with the essential requirements of the relevant European health, safety and environmental protection legislation.

The European Union's "new approach directives" are mandatory on all member countries to enact through national legislation. This legislation requires manufacturers to display a CE marking on their product, packaging and accompanying literature. Where a new approach directive is in force, it is (with few exceptions) an offence to place a product on the market without a CE marking.

The manufacturer is legally responsible for ensuring that the product conforms to the requirements of the directive.

CE marking is one important measure that the EU has adopted to establish the single market and foster economic development for the member states. The objective of the directives is to simplify the movement of goods into and within the EU.

This may eventually lead to the free movement of goods throughout Europe as more and more European countries are expected to join the EU.

The European Commission thus refers to the CE

marking as a "Passport" which allows products to be freely circulated within the EU single market.

Often consumers will consider CE marking on a product as an indication of conformance to laid down minimum standards and therefore, a minimum level of safety which other products may lack. CE marking is for many consumers a "Symbol of Safety."

| | |
|--|---|
| CE |  |
| Meryln Industries Ltd (MER01) | |
| 09 | |
| EN 14428 | |
| Shower enclosures with aluminium profiles and safety glass | |
| Cleanability : Pass | HEIGHT : 1830 |
| Impact resistance/ shatter properties : Pass | DES : WE |
| Durability : Pass | ALUMINIUM : BRASS |
| | COLOR : CHROME |
| | GLASS : CLEAR |
| | CODE : VSM009 |
| | HEIGHT : 1830 |
| | NO : T0904 |
| | REVISION : 1 |



MERLYN invests heavily in its product development and as such guarantees that its glass fully complies with regulations and is manufactured in accordance with BS EN

14428. The rigorous testing of the glass ensures that the endurance, stability and water retention criteria meet high industry standards.

ISO Certification

MERLYN has implemented an Integrated Management System comprising of Quality Management, Environmental Management and Occupational Health and Safety Management. An Integrated Management System ensures the seamless integration of several different standards into a common system that meets the requirements of each of these standards. These certifications are proof of MERLYN's credibility but also to instil confidence in our potential clients that MERLYN will keep its promises.



Inline Panel - *Space Solutions*

Our 6 Series range includes the option of additional Inline Panels to ensure the 6 Series can be used in any space from 670mm to 1915mm. Simply choose the adjustment for your space and we will create the ideal combination for you.

Inline Panels

6 Series Inline Panels

| Adjustment/ Wetroom Min-Max | Order Code | Price £ Exc. VAT | Price £ Inc. VAT |
|-----------------------------------|---------------|---------------------|---------------------|
| 140 | M6I125 | 242.72 | 291.26 |
| 215 | M6I200 | 245.91 | 305.90 |

Sliding Door - and Inline panel

Sliding Door

| Size | Size of Door Supplied | Order Code | Inline Panel Supplied | Price £ Exc. VAT | Price £ Inc. VAT |
|-----------|-----------------------------|---------------|-----------------------------|---------------------|---------------------|
| 950-1000 | 1000 | M68231 | - | 543.49 | 652.19 |
| 1050-1100 | 1100 | M68251 | - | 543.49 | 652.19 |
| 1065-1140 | 1000 | M68231P1H | 140 | 909.82 | 1091.78 |
| 1140-1215 | 1000 | M68231P2H | 215 | 922.01 | 1106.42 |
| 1150-1200 | 1200 | M68241 | - | 543.49 | 652.19 |
| 1165-1240 | 1100 | M68251P1H | 140 | 786.21 | 943.45 |
| 1240-1315 | 1100 | M68251P2H | 215 | 798.40 | 958.09 |
| 1265-1340 | 1200 | M68241P1H | 140 | 786.21 | 943.45 |
| 1340-1415 | 1200 | M68241P2H | 215 | 798.40 | 958.09 |
| 1350-1400 | 1400 | M68291 | - | 667.10 | 800.52 |
| 1360-1460 | 1100 | M68251PPH | 140+215 | 1041.12 | 1249.35 |
| 1450-1500 | 1500 | M68261 | - | 710.47 | 852.57 |
| 1465-1540 | 1400 | M68291P1H | 140 | 909.82 | 1091.78 |
| 1540-1615 | 1400 | M68291P2H | 215 | 922.01 | 1106.42 |
| 1550-1600 | 1600 | M68271 | - | 750.61 | 900.74 |
| 1565-1640 | 1500 | M68261P1H | 140 | 953.19 | 1143.83 |
| 1640-1715 | 1500 | M68261P2H | 215 | 965.39 | 1158.47 |
| 1650-1700 | 1700 | M68281 | - | 750.61 | 900.74 |
| 1665-1740 | 1600 | M68271P1H | 140 | 993.33 | 1192.00 |
| 1740-1815 | 1600 | M68271P2H | 215 | 1005.53 | 1206.63 |
| 1765-1840 | 1700 | M68281P1H | 140 | 993.33 | 1192.00 |
| 1840-1915 | 1700 | M68281P2H | 215 | 1005.53 | 1206.63 |

Please add 20mm to size when using with a Side Panel.
Optional Side Panel available: [See Page 55.](#)

Pivot Door - and Inline panel

Pivot Door

| Size | Size of Door Supplied | Order Code | Inline Panel Supplied | Price £ Exc. VAT | Price £ Inc. VAT |
|-----------|-----------------------------|---------------|-----------------------------|---------------------|---------------------|
| 670-720 | 700 | M61201 N | - | 391.51 | 469.82 |
| 690-740 | 700 | M61201H | EXT | 449.30 | 539.16 |
| 740-790 | 760/800 | M61211 N | - | 440.79 | 528.95 |
| 785-860 | 700 | M61201P1H | 140 | 634.23 | 761.08 |
| 850-900 | 900 | M61221 N | - | 462.10 | 554.52 |
| 860-935 | 700 | M61211P1H | 215 | 646.43 | 775.71 |
| 930-1005 | 760/800 | M61211P2H | 215 | 695.70 | 834.84 |
| 950-1000 | 1000 | M61231 N | - | 487.09 | 584.50 |
| 965-1040 | 900 | M61221P1H | 140 | 704.82 | 845.78 |
| 1040-1115 | 900 | M61221P2H | 215 | 717.01 | 860.42 |
| 1065-1140 | 1000 | M61231P1H | 140 | 729.81 | 875.77 |
| 1140-1215 | 1000 | M61231P2H | 215 | 742.00 | 890.40 |

Please add 20mm to size when using a Side Panel
Optional Side Panel available: [See page 57](#)

Bifold Door - and Inline panel

Sliding Door

| Size | Size of Door Supplied | Order Code | Inline Panel Supplied | Price £ Exc. VAT | Price £ Inc. VAT |
|-----------|-----------------------------|---------------|-----------------------------|---------------------|---------------------|
| 670-720 | 700 | M67201 N | - | 607.85 | 729.43 |
| 690-740 | 700 | M67201H | EXT | 665.64 | 798.77 |
| 740-790 | 760/800 | M67211 N | - | 607.85 | 729.43 |
| 785-860 | 700 | M67201PH | 140 | 850.57 | 1020.69 |
| 850-900 | 900 | M67221 N | - | 651.53 | 781.83 |
| 860-935 | 700 | M67201P2H | 215 | 862.77 | 1035.32 |
| 930-1005 | 760/800 | M67211P2H | 215 | 862.77 | 1035.32 |
| 950-1000 | 1000 | M67231 N | - | 685.23 | 822.27 |
| 965-1040 | 900 | M67221P1H | 140 | 894.25 | 1073.10 |
| 1040-1115 | 900 | M67221P2H | 215 | 906.44 | 1087.73 |
| 1065-1140 | 1000 | M67231P1H | 140 | 927.95 | 1113.54 |
| 1140-1215 | 1000 | M67231P2H | 215 | 940.14 | 1128.17 |

Please add 20mm to size when using with a Side Panel.
Optional Side Panel available: [See Page 59.](#)

Inline Panel - *Space Solutions*

Our 8 Series range includes the option of additional Inline Panels to ensure the 8 Series can be used in any space from 650mm to 1900mm. Simply choose the adjustment for your space and we will create the ideal combination for you.

Inline Panels

| 8 Series Inline Panels | | | |
|-----------------------------------|----------------|---------------------|---------------------|
| Adjustment/ Wetroom Min-Max | Order Code* | Price £ Exc. VAT | Price £ Inc. VAT |
| 150 | M8P140 | 255.98 | 307.17 |
| 210 | M8P2200 | 268.04 | 321.64 |

Sliding Door

- and Inline Panel

| Sliding Door | | | | | |
|--------------|-----------------------------|---------------|-----------------------------|---------------------|---------------------|
| Size | Size of Door Supplied | Order Code | Inline Panel Supplied | Price £ Exc. VAT | Price £ Inc. VAT |
| 950-990 | 1000 | M88231 | - | 761.95 | 914.34 |
| 1050-1090 | 1100 | M88251 | - | 761.95 | 914.34 |
| 1080-1140 | 1000 | M88231P1H | 150 | 1017.93 | 1221.51 |
| 1140-1200 | 1000 | M88231P2H | 210 | 1029.99 | 1235.99 |
| 1150-1190 | 1200 | M88241 | - | 761.95 | 914.34 |
| 1180-1240 | 1100 | M88251P1H | 150 | 1017.93 | 1221.51 |
| 1240-1300 | 1100 | M88251P2H | 210 | 1029.99 | 1235.99 |
| 1280-1340 | 1200 | M88241P1H | 150 | 1017.93 | 1221.51 |
| 1340-1400 | 1200 | M88241P2H | 210 | 1029.99 | 1235.99 |
| 1250-1290 | 1300 | M88240 | - | 926.23 | 1111.47 |
| 1350-1390 | 1400 | M88291 | - | 963.25 | 1155.89 |
| 1370-1450 | 1100 | M88251H | 150+210 | 1285.97 | 1543.16 |
| 1450-1490 | 1500 | M88261 | - | 996.70 | 1196.04 |
| 1480-1540 | 1400 | M88291P1H | 150 | 1219.22 | 1463.07 |
| 1540-1600 | 1400 | M88291P2H | 210 | 1231.28 | 1477.54 |
| 1550-1590 | 1600 | M88271 | - | 1008.99 | 1210.79 |
| 1580-1640 | 1500 | M88261P1H | 150 | 1252.68 | 1503.21 |
| 1640-1700 | 1500 | M88261P2H | 210 | 1264.74 | 1517.68 |
| 1650-1690 | 1700 | M88281 | - | 1058.14 | 1269.77 |
| 1680-1740 | 1600 | M88271P1H | 150 | 1264.96 | 1517.96 |
| 1740-1800 | 1600 | M88271P2H | 210 | 1277.02 | 1532.43 |
| 1780-1840 | 1700 | M88281P1H | 150 | 1314.12 | 1576.94 |
| 1840-1900 | 1700 | M88281P2H | 210 | 1326.18 | 1591.41 |

Please add 20mm to size when using with a Side Panel.
Optional Side Panel available: [See Page 39.](#)

Hinge Door

- and Inline Panel

| Sliding Door | | | | | |
|--------------|-----------------------------|---------------|-----------------------------|---------------------|---------------------|
| Size | Size of Door Supplied | Order Code | Inline Panel Supplied | Price £ Exc. VAT | Price £ Inc. VAT |
| 650-690 | 700 | M81201 | - | 696.06 | 835.28 |
| 670-710 | 700 | M81201H | EXT. | 758.84 | 910.61 |
| 710-750 | 760 | M81210 | - | 697.46 | 836.96 |
| 750-790 | 800 | M81211 | - | 697.46 | 836.96 |
| 780-840 | 700 | M81201PH | 150 | 952.04 | 1142.45 |
| 840-900 | 700 | M81210P1H | 210 | 964.10 | 1156.92 |
| 850-890 | 900 | M81221 | - | 772.14 | 926.57 |
| 900-960 | 760 | M81210P2H | 210 | 965.50 | 1158.60 |
| 950-990 | 1000 | M81231 | - | 817.48 | 980.98 |
| 940-1000 | 800 | M81211PH | 210 | 965.50 | 1158.60 |
| 980-1040 | 900 | M81221P1H | 150 | 1028.12 | 1233.74 |
| 1040-1100 | 900 | M81221P2H | 210 | 1040.18 | 1248.21 |
| 1080-1140 | 1000 | M81231P1H | 150 | 1073.46 | 1288.15 |
| 1140-1200 | 1000 | M81231P2H | 210 | 1085.52 | 1302.62 |

Please add 20mm to size when using with a Side Panel.
Optional Side Panel available: [See Page 41.](#)

Infold Door

- and Inline Panel

| Sliding Door | | | | | |
|--------------|-----------------------------|---------------|-----------------------------|---------------------|---------------------|
| Size | Size of Door Supplied | Order Code | Inline Panel Supplied | Price £ Exc. VAT | Price £ Inc. VAT |
| 650-690 | 700 | M84401 | - | 737.38 | 884.85 |
| 670-710 | 700 | M84401H | EXT. | 800.16 | 960.19 |
| 710-750 | 760 | M84410 | - | 749.68 | 899.61 |
| 750-790 | 800 | M84411 | - | 764.41 | 917.30 |
| 780-840 | 700 | M84401P1H | 150 | 993.35 | 1192.02 |
| 840-900 | 700 | M84401P2H | 210 | 1005.41 | 1206.50 |
| 850-890 | 900 | M84421 | - | 775.34 | 930.41 |
| 900-960 | 760 | M84410P1H | 210 | 1017.71 | 1221.25 |
| 950-990 | 1000 | M84431 | - | 843.95 | 1012.74 |
| 940-1000 | 800 | M84411P2H | 210 | 1032.45 | 1238.94 |
| 980-1040 | 900 | M84421P1H | 150 | 1031.32 | 1237.58 |
| 1040-1100 | 900 | M84421P2H | 210 | 1043.38 | 1252.06 |
| 1080-1140 | 1000 | M84431P1H | 150 | 1099.93 | 1319.91 |
| 1140-1200 | 1000 | M84431P2H | 210 | 1111.99 | 1334.39 |

Please add 20mm to size when using with a Side Panel.
Optional Side Panel available: [See Page 43.](#)

Packaging guide

Please note from our packaging guide the number of boxes your door will be supplied in, depending on its size and model.

Side Panels are supplied in a separate, extra box.

If the enclosure ordered is not listed in the guide, the product, installation guide and fixing kit are supplied in 1 box.

Some products are handed, please state Right Hand (R) or Left Hand (L) when ordering.

Grey boxes denote location of installation guide and fixing kit

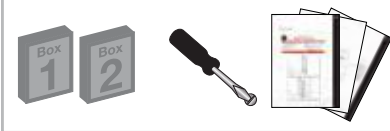

Please Note

Prices were correct at time of print April 2019. V.A.T. at the rate of 20%. E&OE. Due to circumstances beyond our control, prices may be altered including changes to the rate of V.A.T.

Due to our policy of continuous improvement, we reserve the right to amend prices, specifications and designs without prior notice. Images are for illustrated purposes only. The colours and finishes shown in the catalogue are as accurate as possible with in the limits of the printing process. All descriptions, specifications and particulars contained in this brochure are intended merely to represent a general idea of the products described herein and none of these form part of any contract to give rise to any independent or collateral liability upon the company.

10 Series Sliding Door



Fixed Flat Panel Moving Panel (Door) Left or Right

10 Series Pivot Door & Inline Panel



Pivot Door Inline Panel

10 Series 1 Door Offset Quadrant



Curved Fixed Panel Left or Right Moving Panel (Door) Fixed Flat Panel

10 Series 1 Door Quadrant



Curved Fixed Panel Left or Right Moving Panel (Door) Fixed Flat Panel

8 Series Frameless Hinge & Inline



Fixed Panel Left or Right Moving Panel (Door)

*900 Hinge and Inline is supplied in one box

8 Series Frameless 1 Door Quadrant



Moving Panel (Door), Hinged Fixed Panel Magnetic Fixed Panel

8 Series Frameless 1 Door Offset Quadrant



Moving Panel (Door), Hinged Fixed Panel Magnetic Fixed Panel

8 Series Frameless Sliding Door



Fixed Panel Moving Panel (Door)

8 Series 1 Door Quadrant



Fixed Panel Moving Panel (Door)

8 Series 2 Door Quadrant



Fixed Panel Moving Panel (Door)

8 Series 1 Door Offset Quadrant



Fixed Panel Moving Panel (Door)

8 Series Sliding Door



Fixed Panel Moving Panel (Door)

8 Series Infold Door & Inline Panel



Fixed Panel Moving Panel (Door)

8 Series Walk In



Curved Fixed Panel, Straight Fixed Panel

6 Series 1 Door Offset Quadrant



Curved Fixed Panel, Straight Fixed Panel

6 Series Framless Hinge & Inline



Fixed Panel Moving Panel with hardware

*1000, 1100 & 1200 are packaged in one box

6 Series enclosures come in 1 box, with the exception of the 1 Door Offset Quadrant as noted and Sliding Doors of 1400mm or more.

MERLYN

Unit 8, Purcellsinch Industrial Park, Dublin Road, Kilkenny, Ireland, R95 HP71.

T 0808 1011 429 / F 0808 1011 428

www.merlynshowering.com



MERLYN series



MERLYN | BLACK



BACK TO BLACK

MERLYN launched its highly anticipated MERLYN Black range last year and now 2019 brings the addition of even more sleek and stylish options to transform your bathroom space and make it the statement piece you desire.

With its anodised matte black finish, the MERLYN Black range is the best on the market and the envy of all who try to compete. With the option of Frameless, Framed and Squared Showerwalls, a Sliding Door and Hinge & Inline enclosure as well as 3 Bath Screens, this range offers you a fashionable solution for a variety of situations.

As standard with this 8mm range is the MERLYN Lifetime Guarantee and Mershield Stayclear protective glass coating. Quality, peace of mind and a touch of class all in one choice.

Another reason to always Make it a MERLYN.

Contents

02 Sliding Door

04 Hinge & Inline

06 Frameless Showerwalls

08 Framed Showerwall **NEW**

10 Squared Showerwall **NEW**

12 Bath Screens **NEW**



*The materials used in our **MERLYN** Black range are anodised aluminium with a matte black finish. This is much more durable than standard powder coating and ensures our Lifetime Guarantee.*

MERLYN | BLACK



Sliding Door / Shown with Side Panel

technical drawing.

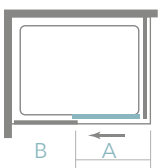

A: Door Opening
B: Fixed Panel

| Side Panel | | | |
|------------|-----|-----|--|
| Size | A | B | |
| 1200 | 450 | 560 | |
| 1400 | 550 | 660 | |
| 1500 | 550 | 760 | |
| 1700 | 550 | 960 | |

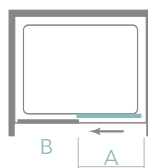

A: Door Opening
B: Fixed Panel

| Recess | | | |
|--------|-----|-----|--|
| Size | A | B | |
| 1200 | 468 | 560 | |
| 1400 | 568 | 660 | |
| 1500 | 568 | 760 | |
| 1700 | 568 | 960 | |

8^{MM}
GLASS
THICKNESS

LIFETIME
GUARANTEE

MERSHIELD
STAYCLEAR

Sliding Door

The MERLYN Black Sliding Door brings with it the smoothest rolling action possible in 8mm glass. With stunning designer features and its sleek, minimal matte black frame, this enclosure symbolises style that will stand out in your bathroom space.

features.

- Height 2000mm
- Black seals
- Concealed fittings
- Anodised aluminium matte black finish - more durable than powder coating
- Smooth action rollers
- Reversible
- Wetroom compatible

| Sliding Door | | | | | | Add a MERLYN MStone Tray | | |
|--------------|------------------------------|-------------------------------|-------------|------------------|------------------|--------------------------|------------------|------------------|
| Size | Product Adjustment in Recess | Product Adjustment Side Panel | Order Code | Price £ Exc. VAT | Price £ Inc. VAT | Order Code* | Price £ Exc. VAT | Price £ Inc. VAT |
| 1200 | 1150-1190 | 1140-1165 | BLKFSL1200H | 774.35 | 929.22 | BLKBFSL1200H | 949.83 | 1139.80 |
| 1400 | 1350-1390 | 1340-1365 | BLKFSL1400H | 892.50 | 1071.00 | BLKBFSL1400H | 1156.00 | 1387.20 |
| 1500 | 1450-1490 | 1440-1465 | BLKFSL1500H | 934.15 | 1120.98 | BLKBFSL1500H | 1234.52 | 1481.43 |
| 1700 | 1650-1690 | 1640-1665 | BLKFSL1700H | 1019.15 | 1222.98 | BLKBFSL1700H | 1375.90 | 1651.08 |

*Order code for ordering a shower enclosure and tray. Please allow 5mm - 15mm step-in on the tray. See table below for waste cap options.

| Optional Side Panel | | | | |
|---------------------|--------------------|------------|------------------|------------------|
| Size | Product Adjustment | Order Code | Price £ Exc. VAT | Price £ Inc. VAT |
| 800 | 760-785 | BLKFSP800 | 405.45 | 486.54 |
| 900 | 860-885 | BLKFSP900 | 430.10 | 516.12 |

Please allow 5mm - 25mm step-in on the tray.

| Additional Options | | | | |
|--------------------------------|------|------------|------------------|------------------|
| | Size | Order Code | Price £ Exc. VAT | Price £ Inc. VAT |
| Sliding Door Extension Profile | 2000 | BLKFSLEXT | 79.00 | 94.80 |
| White Waste Cap | | DWASCAPWHT | 9.95 | 11.94 |

MERLYN Black extension profile: extra 20mm. Extension Profile is matte black. White Waste Cap is for MStone and Touchstone trays only. Waste cap comes in chrome as standard.

DID YOU KNOW?

The black colour layer is not applied to the surface like paint or plating, but is fully integrated with the underlying aluminium substrate, so it cannot chip or peel.



Sliding Door / in a Recess

MERLYN | BLACK



Hinge and Inline / with Side Panel

technical drawing.

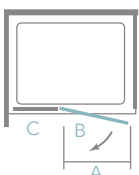

A: Door Opening
B: Door Swing
C: Fixed Panel

+ sizes indicate Side Panel opening

| Size | A | B | C |
|-------|-----|-----|-----|
| 900 | 490 | 520 | 250 |
| 900+ | 530 | 560 | 250 |
| 1000 | 540 | 570 | 300 |
| 1000+ | 580 | 610 | 300 |
| 1200 | 590 | 620 | 450 |
| 1200+ | 630 | 660 | 450 |
| 1400 | 590 | 620 | 670 |
| 1400+ | 630 | 660 | 670 |



Stabilising Bar

8^{MM}
GLASS
THICKNESS

LIFETIME
GUARANTEE

MERSHIELD
STAYCLEAR

Hinge and Inline

This new frameless enclosure fuses style and elegance with practical functionality. The MERLYN Black Hinge & Inline enclosure creates a fabulous contrast feature within your bathroom that will be the envy of all who visit.

features.

- Height 2000mm
- Black seals
- 8mm toughened glass
- Anodised aluminium matte black finish - more durable than powder coating
- Luxury metal handle
- Sleek designer bracing bar
- Reversible

| Hinge & Inline in Recess | | | | | Add a MERLYN MStone Tray | | |
|--------------------------|--------------------|--------------|------------------|------------------|--------------------------|------------------|------------------|
| Size | Product Adjustment | Order Code | Price £ Exc. VAT | Price £ Inc. VAT | Order Code* | Price £ Exc. VAT | Price £ Inc. VAT |
| 900 | 860-900 | BLKH900REC | 905.25 | 1086.30 | BLKBH900REC | 1053.10 | 1263.72 |
| 900+ | 900-940 | BLKH900SP | 905.25 | 1086.30 | BLKBH900SP | 1053.10 | 1263.72 |
| 1000 | 960-1000 | BLKH1000REC | 905.25 | 1086.30 | BLKBH1000REC | 1072.24 | 1286.69 |
| 1000+ | 1000-1040 | BLKH1000SP | 905.25 | 1086.30 | BLKBH1000SP | 1072.24 | 1286.69 |
| 1200 | 1160-1200 | BLKH1200RECH | 980.90 | 1177.08 | BLKBH1200RECH | 1156.38 | 1387.66 |
| 1200+ | 1200-1240 | BLKH1200SPH | 980.90 | 1177.08 | BLKBH1200SPH | 1156.38 | 1387.66 |
| 1400 | 1360-1400 | BLKH1400RECH | 1231.65 | 1477.98 | BLKBH1400RECH | 1495.15 | 1794.18 |
| 1400+ | 1400-1440 | BLKH1400SPH | 1231.65 | 1477.98 | BLKBH1400SPH | 1495.15 | 1794.18 |

*Order code for ordering a shower enclosure and tray. See table below for waste cap options.

| Hinge & Inline sizes for use with Side Panel | | | | | Add a MERLYN MStone Tray | | |
|--|--------------------|-------------|------------------|------------------|--------------------------|------------------|------------------|
| Size | Product Adjustment | Order Code | Price £ Exc. VAT | Price £ Inc. VAT | Order Code* | Price £ Exc. VAT | Price £ Inc. VAT |
| 900+ | 870-890 | BLKH900SP | 905.25 | 1086.30 | BLKBH900SP | 1053.10 | 1263.72 |
| 1000+ | 970-990 | BLKH1000SP | 905.25 | 1086.30 | BLKBH1000SP | 1072.24 | 1286.69 |
| 1200+ | 1070-1090 | BLKH1200SPH | 980.90 | 1177.08 | BLKBH1200SPH | 1156.38 | 1387.66 |
| 1400+ | 1370-1390 | BLKH1400SPH | 1231.65 | 1477.98 | BLKBH1400SPH | 1495.15 | 1794.18 |

Optional Side Panel to match + sizes only

| Size | Product Adjustment | Order Code | Price £ Exc. VAT | Price £ Inc. VAT |
|------|--------------------|------------|------------------|------------------|
| 760 | 730-750 | BLKHSP760 | 404.60 | 485.52 |
| 800 | 770-790 | BLKHSP800 | 404.60 | 485.52 |
| 900 | 870-890 | BLKHSP900 | 404.60 | 485.52 |

Additional Options

| | Size | Order Code | Price £ Exc. VAT | Price £ Inc. VAT |
|----------------------------------|------|------------|------------------|------------------|
| Hinge & Inline Extension Profile | 2000 | BLKHEXT | 79.00 | 94.80 |
| White Waste Cap | | DWASCAPWHT | 9.95 | 11.94 |

MERLYN Black extension profile: extra 20mm. Extension Profile is matte black. White Waste Cap is for MStone and Touchstone trays only. Waste cap comes in chrome as standard.

DID YOU KNOW?

The black colour layer is not applied to the surface like paint or plating, but is fully integrated with the underlying aluminium substrate, so it cannot chip or peel.

MERLYN | BLACK



Frameless Showerwall



Frameless Showerwall with End Panel



Frameless Showerwall with Vertical Post

8^{MM}
GLASS
THICKNESS

LIFETIME
GUARANTEE

MERSHIELD
STAYCLEAR

Frameless Showerwalls

The MERLYN Black Frameless Showerwall comes in several sizes, offering you the option to mix and match your choice of space combinations. With 8mm glass and the option of a matte black vertical post, this stylish Showerwall brings a strong feature with great height to your bathroom.

features.

- Height 2015mm including rail
- Minimalist frameless design
- Anodised aluminium matte black finish - more durable than powder coating
- Reversible
- Suitable for wetroom and shower tray application

Frameless Showerwall

| Size | Adjustment | Order Code | Price £ Exc. VAT | Price £ Inc. VAT |
|------|------------|------------|---------------------|---------------------|
| 700 | 675-690 | BLKSW700 | 500.65 | 600.78 |
| 800 | 775-790 | BLKSW800 | 500.65 | 600.78 |
| 900 | 875-890 | BLKSW900 | 523.60 | 628.32 |
| 1000 | 975-990 | BLKSW1000 | 530.40 | 636.48 |
| 1100 | 1075-1090 | BLKSW1100 | 551.65 | 661.98 |
| 1200 | 1175-1190 | BLKSW1200 | 559.30 | 671.16 |

See table below for waste cap options.

**Please note: Vertical Post is an optional extra and must be ordered if required. See information below.

Additional Options

| | Size | Order Code | Price £ Exc. VAT | Price £ Inc. VAT |
|-----------------|--------------|------------|---------------------|---------------------|
| Corner Profile | Max 3 metres | A04S0003BN | 83.10 | 99.72 |
| Vertical Post** | Max 3 metres | BLK3MCP | 169.15 | 202.98 |
| Swivel Panel | 300 | BLKSVL300 | 325.00 | 390.00 |
| White Waste Cap | | DWASCAPWHT | 9.95 | 11.94 |

White Waste Cap is for MStone and Touchstone trays only. Waste cap comes in chrome as standard. The Swivel Panel can be retro fitted. Radius of Swivel Panel = 315mm. 180° opening.

DID YOU KNOW?

The black colour layer is not applied to the surface like paint or plating, but is fully integrated with the underlying aluminium substrate, so it cannot chip or peel.



Frameless Showerwall with Swivel Panel



Corner Profile

technical drawing

Showerwall with End Panel

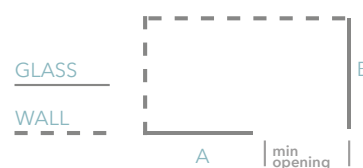

A: Front Panel
B: End Panel

Recommended opening min 500mm



Framed Showerwall



Framed Walk In



Framed Showerwall

The framed beauty that is the MERLYN Black Framed Showerwall is here to transform your bathroom. Creating a feature of your showering space, this new arrival from MERLYN gives you style options to use as a Showerwall or Walk-In. The anodised matte black frame guarantees the perfect finish expected as standard from MERLYN.

features.

- Height 2000
- Reversible
- Anodised aluminium matte black finish - more durable than powder coating
- Bracing bar sits flush with shower panel
- Suitable for wetroom and shower tray application

Framed Showerwall

| Size | Adjustment | Order Code | Price £ Exc. VAT | Price £ Inc. VAT |
|------|------------|------------|---------------------|---------------------|
| 800 | 775-790 | BLKFSW80 | 679.00 | 814.80 |
| 900 | 875-890 | BLKFSW90 | 709.00 | 850.80 |
| 1000 | 975-990 | BLKFSW100 | 719.00 | 862.80 |
| 1200 | 1175-1190 | BLKFSW120 | 759.00 | 910.80 |

See table below for waste cap options. Bracing bar comes as standard on all sizes.

Additional Options

| | Size | Order Code | Price £ Exc. VAT | Price £ Inc. VAT |
|-----------------|------|--------------|---------------------|---------------------|
| White Waste Cap | | DWASCAPWHT | 9.95 | 11.94 |
| Stabilising bar | | BLKFSUPBAR1M | 195.00 | 234.00 |

White Waste Cap is for MStone and Touchstone trays only. Waste cap comes in chrome as standard. Please Note: If you would like to choose the Double Entry Framed Showerwall option, please order an additional stabilising bar to complete the enclosure. We recommend a minimum size of 1200mm for the Double Entry Showerwall option.

technical drawing

Walk In

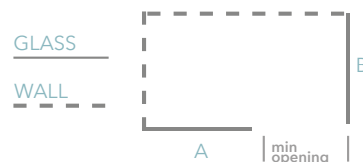

A: Front Panel
B: End Panel

Recommended opening min 500mm

DID YOU KNOW?

The black colour layer is not applied to the surface like paint or plating, but is fully integrated with the underlying aluminium substrate, so it cannot chip or peel.



Fully designed metal frame including horizontal and vertical bars

Squared Showerwall



Squared Walk In



Double Entry Squared Showerwall

We recommend a minimum size of 1200mm for the Double Entry Showerwall option.

Please order an extra stabilising bar to complete this enclosure.



Squared Showerwall

This hotly anticipated trend has landed from MERLYN. As standard with our MERLYN Black range, the anodised MERLYN Black Squared Showerwall is the best to arrive onto the scene. Available in a choice of three sizes allowing you to create a Showerwall or Walk-In feature, this fashioned statement piece gives your bathroom the wow it's been waiting for.

features.

- Height 2000
- Reversible
- Anodised aluminium matte black finish- more durable than powder coating
- Bracing bar sits flush with shower panel
- Suitable for wetroom and shower tray application
- Full metal frame on the outside only - retaining easy clean feature on inside

| Squared Showerwall | | | | |
|--------------------|------------|--------------|---------------------|---------------------|
| Size | Adjustment | Order Code | Price £ Exc. VAT | Price £ Inc. VAT |
| 900 | 875-890 | BLKFSWCTL90 | 1059.00 | 1270.80 |
| 1000 | 975-990 | BLKFSWCTL100 | 1079.00 | 1294.80 |
| 1200 | 1175-1190 | BLKFSWCTL120 | 1139.00 | 1366.80 |

See table below for waste cap options. Bracing bar comes as standard on all sizes.

| Additional Options | | | | |
|--------------------|------|--------------|---------------------|---------------------|
| | Size | Order Code | Price £ Exc. VAT | Price £ Inc. VAT |
| White Waste Cap | | DWASCAPWHT | 9.95 | 11.94 |
| Stabilising bar | | BLKFSUPBAR1M | 195.00 | 234.00 |

White Waste Cap is for MStone and Touchstone trays only. Waste cap comes in chrome as standard. Please Note: If you would like to choose the Double Entry Squared Showerwall option, please order an additional stabilising bar to complete the enclosure. We recommend a minimum size of 1200mm for the Double Entry Showerwall option.

technical drawing

Walk In

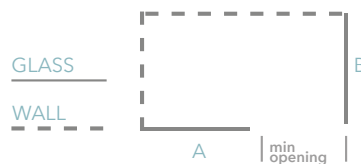

A: Front Panel
B: End Panel

Recommended opening min 500mm

DID YOU KNOW?

The black colour layer is not applied to the surface like paint or plating, but is fully integrated with the underlying aluminium substrate, so it cannot chip or peel.

MERLYN | BLACK



Framed Bath Screen



Framed Bath Screen

To add to our MERLYN Black range of options is the beautiful Framed Bath Screen. Not to neglect the multi-functional bathroom space, this addition to the range offers a fashionable choice allowing that striking feature that your bathroom space deserves.

features.

- Anodised aluminium matte black finish - more durable than powder coating
- Reversible

Framed Bath Screen

| Size | Panel | Order Code | Price £ Exc. VAT | Price £ Exc. VAT |
|------------|-------|------------|---------------------|---------------------|
| 800 x 1500 | 1 | BLKFMB0 | 475.00 | 570.00 |

technical drawing

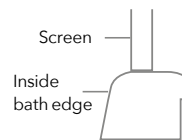
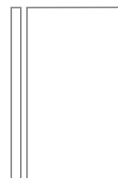

Please ensure product is fitted with panel positioned in line with the inside bath edge.

Recommended shower head position

DID YOU KNOW?

The black colour layer is not applied to the surface like paint or plating, but is fully integrated with the underlying aluminium substrate, so it cannot chip or peel.

2 Panel Hinged Bath Screen



2 Panel Hinged Bath Screen

The MERLYN Black 2 Panel Hinged Bath Screen stylishly complements the multi-functional bathroom, ensuring that every bathroom can be on-trend.

features.

- Minimalist frameless design
- Anodised aluminium matte black finish- more durable than powder coating
- This product is handed

| 2 Panel Hinged | | | | |
|----------------|-------|------------|------------------|------------------|
| Size | Panel | Order Code | Price £ Exc. VAT | Price £ Inc. VAT |
| 900 x 1500 | 2 | BLKMB7L | 509.15 | 610.98 |
| 900 x 1500 | 2 | BLKMB7R | 509.15 | 610.98 |

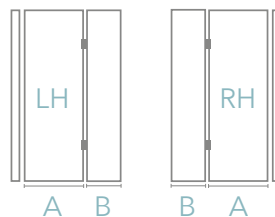
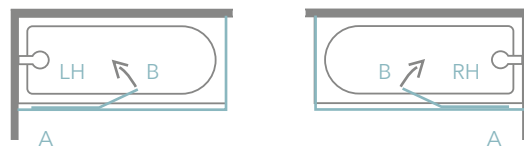

Door Swing: 180 Degrees inwards only

A: Fixed Panel = 497mm
B: Radius of Screen Swing = 383mm

DID YOU KNOW?

The black colour layer is not applied to the surface like paint or plating, but is fully integrated with the underlying aluminium substrate, so it cannot chip or peel.

Fixed Square Bath Screen



8^{MM}
GLASS
THICKNESS

LIFETIME
GUARANTEE

MERSHIELD
STAYCLEAR

Fixed Square Bath Screen

The MERLYN Black Fixed Panel Bath Screens offers a sleek, minimalistic aesthetic to the multi-functional bathroom, creating a feeling of space and luxury.

features.

- Minimalist frameless design
- Anodised aluminium matte black finish- more durable than powder coating
- Reversible

| Fixed Square | | | | |
|--------------|-------|------------|---------------------|---------------------|
| Size | Panel | Order Code | Price £ Exc. VAT | Price £ Exc. VAT |
| 800 x 1500 | 1 | BLKMB0 | 209.00 | 250.80 |

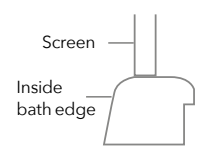
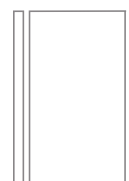
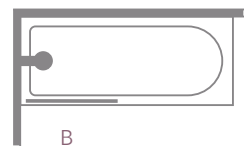

Please ensure product is fitted with panel positioned in line with the inside bath edge.

 Recommended shower head position

DID YOU KNOW?
The black colour layer is not applied to the surface like paint or plating, but is fully integrated with the underlying aluminium substrate, so it cannot chip or peel.



www.vado.com

GEOMETRIC TRENDS



www.johnson-tiles.com



www.johnson-tiles.com



www.vado.com



www.vado.com



www.vado.com

I have said that black has it all. White too. Their beauty is absolute.

It is the perfect harmony.

- Coco Chanel

Paying homage to the celebrated designer Coco Chanel, her statement is as true in interiors as it is in fashion, the stylish simplicity of the black and white pairing works like no other colour combo. At MERLYN we love the contrasts of light and dark and the clever use of accessories to create a bathroom which beautifully fuses aesthetics and functionality. The bathroom is a sanctuary, together we can make it sublime.

Contrast colours and textures for a cohesive look. Invest in quality products with classic styles to deliver a finish which stands the test of time.



www.johnson-tiles.com

MERLYN

Unit 8, Purcellsinch Industrial Park, Dublin Road, Kilkenny, Ireland, R95 HP71.

T 0808 1011 429 / F 0808 1011 428

www.merlynshowering.com



MERLYN | BLACK



STERLING