

PRODUCT DATA SHEET



PRODUCT CODE

SE6000DWG

RANGE

SVELTE

DESCRIPTION

600mm Basin Unit White Gloss

COLOUR	White Gloss
COLOUR CODE/ REFERENCE	Crosswater Exclusive
MATERIAL	16mm and 18mm MDF/MFC Solvent Free Acrylic Lacquer
STANDARDS	EN 13986 EN 14749
INSTALLATION TYPE	Wall-Mounted
DRAWER BOX	Textile Finish MFC Concealed Runners
DRAWER RUNNERS	BLUM Tandem Box - Soft Close Pull To Open
DRAWER EXTENSION	Full Extension
DRAWER ADJUSTMENT	3 Way
DRAWER CAPACITY	30kg
WALL HANGERS	CAMAR With Safety Lock - Factory Fitted 120kg Load Capacity On A Solid Wall 3 Way Adjustment
WEIGHT	29kg
WARRANTY	10 Years

TECHNICAL DIMENSIONS

Dimensions in mm unless otherwise specified.

Tolerances (per material type) apply.

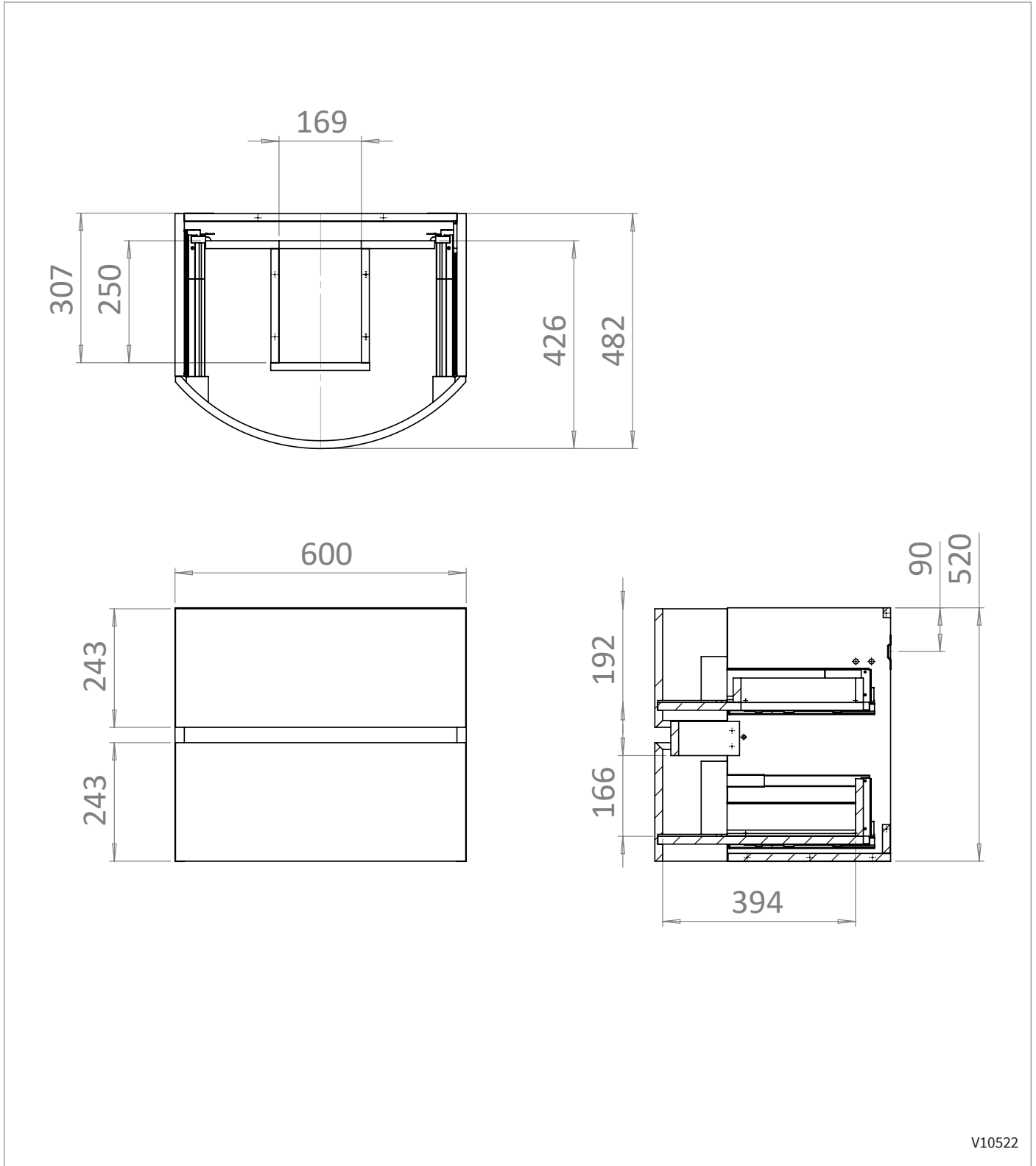

V10522

SPARES DIAGRAM

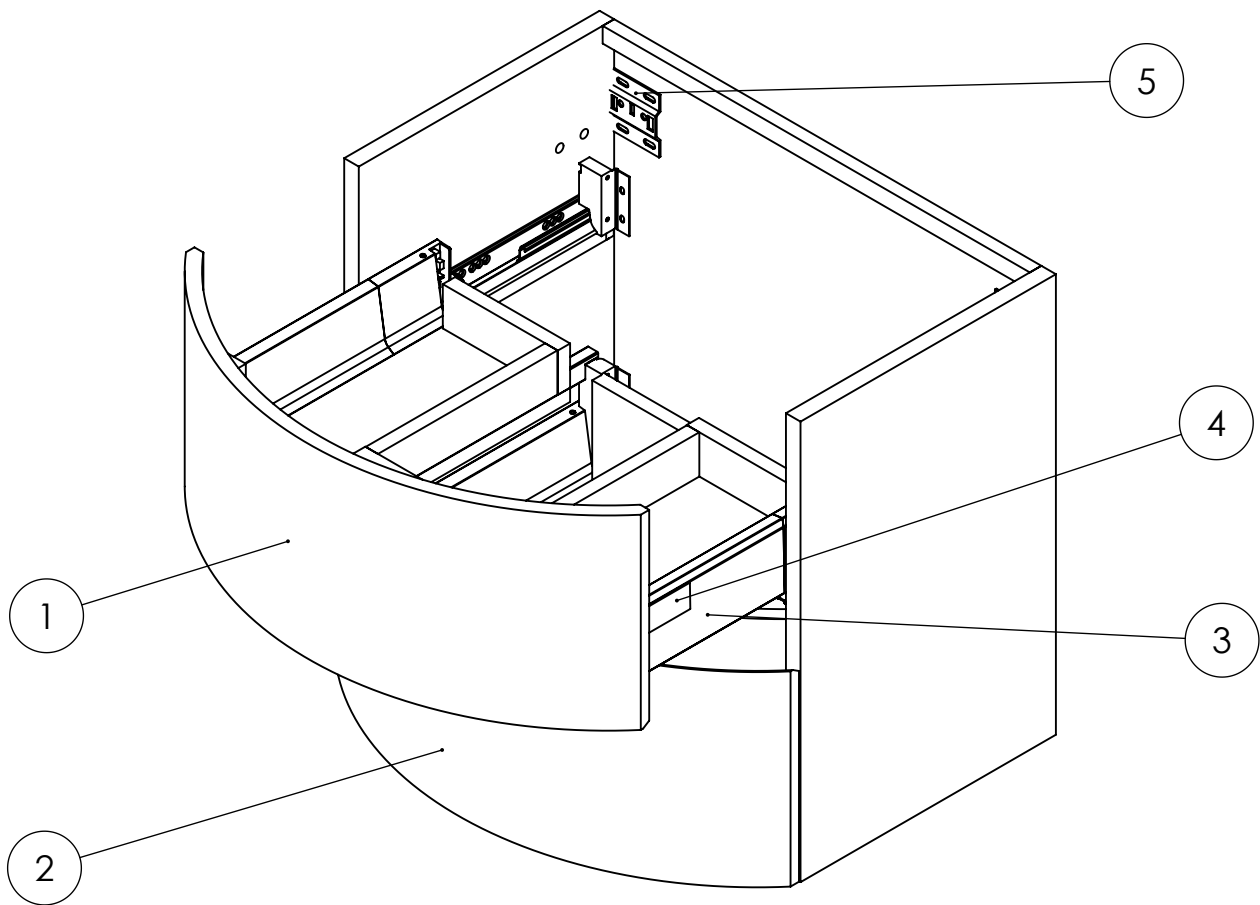

Only the parts labelled are available as spares.

V10522

SPARES DIAGRAM

NUMBER	PART CODE	DESCRIPTION
1	TDF_60SEDGA	Top Drawer Front from SE6000DGA
	TDF_60SEDSG	Top Drawer Front from SE6000DSG
	TDF_60SEDWG	Top Drawer Front from SE6000DWG
	TDF_60SEDAW	Top Drawer Front from SE6000DAW
	TDF_60SEDOB+	Top Drawer Front from SE6000DOB
	TDF_60SDCO+	Top Drawer Front from SE6000SDCO+
2	BDF_60SEDGA	Bottom Drawer Front from SE6000DGA
	BDF_60SEDSG	Bottom Drawer Front from SE6000DSG
	BDF_60SEDWG	Bottom Drawer Front from SE6000DWG
	BDF_60SEDAW	Bottom Drawer Front from SE6000DAW
	BDF_60SEDOB+	Bottom Drawer Front from SE6000DOB
	BDF_60SDCO+	Bottom Drawer Front from SE6000SDCO+
3	RUNNERS_SVELTE	Drawer Runners from the Svelte Furniture
4	SECLIPS	Svelte Drawer Covers x4
5	WB897ASZ16070	Wall Bracket x2

We recommend purchasing the top and bottom drawer fronts for the following codes to ensure the continuity of the naturally formed veneer pattern:

American Walnut

Castilla Oak

Grey Ash

Only the parts labelled are available as spares.

V10522